

# T3<sup>®</sup> and Osseotite<sup>®</sup> Implant Systems

Restorative Manual



# Table of Contents

<b>Overview</b>	<b>4</b>
Introduction	4
Treatment Planning Considerations	4
<b>Pre-Planning Considerations</b>	<b>5</b>
Torque Matrix - Certain® Internal Connection	5
Torque Matrix - External Hex Connection	7
<b>Implant and Abutment System Connections</b>	<b>9</b>
Certain Internal Connection	9
External Hex Connection	10
Certain QuickSeat® Activator Tool	11
Certain Hexed and Non-Hexed Pick-Up Impression Coping Draw Angles	12
Certain UCLA Abutment	13
Certain Non-Hexed Abutments	14
Abutment Selection Guide	15
<b>Implant and Abutment Level Impressions</b>	<b>17</b>
How To Choose A Coping	17
Pick-Up Impression Copings	18
Twist Lock Transfer Impression Copings	21
<b>Cement-Retained Restorations</b>	<b>24</b>
PreFormance Post   Indirect Technique	24
PreFormance Post   Direct Technique	27
15° Pre-Angled PreFormance Post   Indirect Technique	29
15° Pre-Angled PreFormance Post   Direct Technique	31
GingiHue Post   Indirect Technique	33
GingiHue Post   Direct Technique	35
UCLA Abutment   Single-Unit   Indirect Technique	38
UCLA Abutment   Multiple-Unit   Indirect Technique	40

## Important Product Information

### Biomet 3i Restorative Products

For detailed product information on all Biomet 3i Restorative Products, refer to the Biomet 3i website located at [ifu.biomet3i.com](http://ifu.biomet3i.com) to look up the specific part number.

---

<b>Screw-Retained Restorations</b>	<b>43</b>
PreFormance Temporary Cylinder   Single-Unit   Indirect Technique	43
PreFormance Temporary Cylinder   Single Unit   Direct Technique	45
PreFormance Temporary Cylinder   Multiple-Unit   Indirect Technique	46
Titanium Temporary Cylinder   Single-Unit   Indirect Technique	48
Titanium Temporary Cylinder   Multiple-Unit   Indirect Technique	50
BellaTek Express and Flex Abutments	52
UCLA Abutment   Single-Unit   Indirect Technique	54
UCLA Abutment   Multiple-Unit   Indirect Technique	56
Low Profile Abutment   Single-Unit   Indirect Technique	59
Low Profile Abutment   Multiple-Unit   Indirect Technique	61
Conical Abutment   Single-Unit   Indirect Technique	64
Conical Abutment   Multiple-Unit   Indirect Technique	67
<b>Denture Conversion To Fixed Prosthesis</b>	<b>70</b>
QuickBridge® Provisional Restoration   Direct Technique	70
<b>Fabrication Of Provisional To Fixed Prosthesis</b>	<b>72</b>
QuickBridge Provisional Restoration   Indirect Technique	72
<b>Bar-Supported Overdenture</b>	<b>74</b>
Standard Abutment Bar	74
UCLA Abutment Bar	83
<b>Implant-Retained Fixed Prosthesis</b>	<b>87</b>
Low Profile Abutment Fixed Hybrid	87
Standard Abutment Fixed Hybrid	89
UCLA Abutment Fixed Hybrid	91
IOL® Abutment Fixed Hybrid	94
<b>Tissue-Supported Overdenture</b>	<b>96</b>
LOCATOR® Abutment   Indirect Technique	96
LOCATOR Abutment   Direct Technique	101
Dal-Ro Abutment   Indirect Technique	103
Dal-Ro Abutment   Direct Technique	108
Temporary Healing Retention Cylinder   Indirect Technique	110

**Icon Key:**

Certain Internal Connection Implant System:



External Hex Connection Implant System:



**How to Use the Icon Key:**

The icons represent the connection types of the Zimmer Biomet Implant Systems represented in this manual. In the fully illustrated protocols, each icon is present next to each step. The blue icon indicates which system is illustrated. When both icons are displayed, both systems are illustrated.

# Restorative Manual Overview

## Introduction

Zimmer Biomet Implant Systems have been developed to meet the diverse needs of patients and to offer clinicians a choice of surgical and restorative techniques customized to meet each individual's requirements. This manual is designed to serve as a reference guide for clinicians and laboratories utilizing Zimmer Biomet Restorative Components and Instruments and does not address all situations or considerations involved in treatment. The success of any dental implant and abutment system depends upon proper use of the components and instrumentation.

This manual is not intended for use as a substitute for professional training and experience and does not comprise clinical advice. The clinician should use medically sound treatment planning and procedures appropriate for each patient's individual case for predictable results.

Zimmer Biomet offers unique implant and restorative components designed to provide clinicians with a broad range of restorative solutions, including support for single crowns, fixed/removable prostheses and attachments for securing overdentures. Zimmer Biomet Implant and Abutment Systems employ proven restorative designs and provide clinicians and patients with predictable treatment options.

## Treatment Planning Considerations

### Patient Evaluation and Selection

Several important factors must be considered when evaluating a patient prior to implant surgery. The presurgical evaluation must include a cautious and detailed assessment of the patient's general health, current medical status, medical history, oral hygiene, motivation and expectations. If the patient's medical history reveals an existing condition or signals a potential problem that may compromise treatment and/or the patient's well being, consultation with a clinician is recommended.

An extensive intraoral examination should be performed to evaluate the oral cavity for any potential bone or soft-tissue pathology. The clinician should also determine the periodontal status of the remaining teeth, the health of the soft-tissue, the presence of occlusal abnormalities or parafunctional habits, such as bruxism or crossbite and any other conditions that could adversely affect the restorative outcome.

### Preoperative Planning Considerations:

During the presurgical restorative planning phase, it is important for the surgeon, restorative dentist and laboratory technician to participate in determining the type of prosthesis and restorative components that will be used. Such decision-making is critical for determining the location of implants and should be finalized prior to implant surgery. A top-down treatment planning approach is recommended, whereby the definitive prosthesis is designed, implant locations are determined and restorative components are selected prior to initiating implant surgery.

Proper treatment planning, as well as the selection of the proper implant length and diameter are crucial to the long-term success of the implant and restoration. Before an implant can be selected, the anatomical foundation available to receive the implant must be carefully assessed.

Clinical information necessary for determining appropriate treatment options includes but is not limited to: determining vertical dimension, evaluating the space available between the alveolar crest and the opposing dentition to confirm that enough space exists to accommodate the proposed abutment and final restoration, locating the position of important anatomic structures and determining bone dimensions where implants are to be placed. The height required by the restorative components varies with each type of abutment. Therefore, the surgeon and restorative dentist should carefully evaluate abutment dimensions relative to the available restorative space. Diagnostic casts should be used to evaluate tooth and ridge positions, occlusal relationships, amount of space available for implant restorations, implant positioning and angulations. These casts allow the clinician to evaluate the opposing dentition and its effect on implant position. A surgical guide is helpful in determining the precise intraoral position and angulation of the implants and should be included in the preoperative treatment plan.

By visualizing the final design of the prosthesis prior to implant surgery, both restorative and surgical clinicians have the opportunity to identify potential restorative problems. They can then make the necessary modifications to implant selection, location and the overall treatment plan prior to actually placing the implants, thus improving treatment predictability and success.



# Pre-Planning Considerations



## Torque Matrix — Certain Internal Connection

Please use the table below as a guide which Drivers and Driver Tips must be used with Zimmer Biomet Certain Internal threaded devices (e.g. screws and abutments), as well as the recommended torque values for each.

Recommended Torque Matrix – Internal Connection				
Threaded Devices		Recommended Torque Values	Drivers	Driver Tips
IUNITS	Certain Hex Try-In Screw	Hand Tighten	<b>PHD02N</b> - Narrow Posterior Large Hex Driver 17 mm(L) <b>PHD03N</b> - Narrow Posterior Large Hex Driver 24 mm(L)	N/A
IWSU30	Certain Waxing Screw/Guide Pin			
LPCWS	Low Profile Abutment Waxing Screw			
CS2x0	Conical EP® Healing Cap	10 Ncm	<b>PHD02N</b> - Narrow Posterior Large Hex Driver 17 mm(L) <b>PHD03N</b> - Narrow Posterior Large Hex Driver 24 mm(L)	<b>RASH3N</b> - Narrow Right Angle Large Driver Tip (Hexed) 24 mm(L) <b>RASH8N</b> - Narrow Right Angle Large Driver Tip (Hexed) 30 mm(L)
GSHx0	Gold-Tite® Hexed Retaining Screw			
ICS275	Certain Implant Headless Cover Screw			
ICSx00	Certain Implant Straight Cover Screw			
ICSFxx	Certain Flat Implant Cover Screw			
IMCSF34	Certain Micromini Flat Implant Cover Screw			
IMMCS1	Certain Cover Screw			
IOLHC	IOL Healing Cap			
LPCHC	Low Profile Abutment Healing Cap			
LPCGSH	Low Profile Abutment Gold-Tite Retaining Screw			
LPCTSH	Low Profile Abutment Titanium Retaining Screw			
MHC33	Conical Healing Cap			
TS250	Standard Abutment Temporary Screw			
TSH30	Titanium Hexed Screw			
GSX00	Gold Slotted Screw			
IEHAxxx	Certain BellaTek® Encode® Healing Abutment	20 Ncm	<b>PHD02N</b> - Narrow Posterior Large Hex Driver 17 mm(L) <b>PHD03N</b> - Narrow Posterior Large Hex Driver 24 mm(L)	<b>RASH3N</b> - Narrow Right Angle Large Driver Tip (Hexed) 24 mm(L) <b>RASH8N</b> - Narrow Right Angle Large Driver Tip (Hexed) 30 mm(L)
ILPACxxxx	Certain Low Profile Angled Abutment			
ILRGHG	Certain Gold-Tite Large Hexed Screw			
ILRGHT	Certain Titanium Large Hexed Screw			
IMHAxxx	Certain EP Healing Abutment			
ISMHA3x	Certain Straight Healing Abutment 3.4 mm(D)			
ISHA4x	Certain Straight Healing Abutment 4.1 mm(D)			
ISWHAxx	Certain Straight Healing Abutment			

Recommended Torque Matrix – Internal Connection				
Threaded Devices		Recommended Torque Values	Drivers	Driver Tips
ITHAxx	Certain EP Healing Abutment	20 Ncm	<b>PHD02N</b> - Narrow Posterior Large Hex Driver 17 mm(L) <b>PHD03N</b> - Narrow Posterior Large Hex Driver 24 mm(L)	<b>RASH3N</b> - Narrow Right Angle Large Driver Tip (Hexed) 24 mm(L) <b>RASH8N</b> - Narrow Right Angle Large Driver Tip (Hexed) 30 mm(L)
IUNIHG	Certain Gold-Tite Hexed Screw			
IUNIHT	Certain Titanium Hexed Screw			
IABxx0	Certain Standard Abutment	20 Ncm	<b>PAD00</b> - Posterior Abutment Driver 17 mm(L) <b>PAD24</b> - Standard Abutment Driver 24 mm(L)	<b>RASA3</b> - Right Angle Abutment Driver Tip Steel
ICA00x	Certain Conical Abutment			
IIOlxxS	Certain IOL Abutment			
ILPCxxx	Certain Low Profile Abutment			
ILPCxxxU	Certain Low Profile One-Piece Abutment			
IMCA3x	Certain Conical Abutment 3.4 mm(D)			
IWCAxx	Certain Conical Abutment			
ILOA00x	Certain LOCATOR Abutment 4.1 mm(D)	20 Ncm	<b>LCTDR1</b> - LOCATOR Core Tool/Abutment Driver	<b>LOADT4</b> - LOCATOR Abutment Driver Tip 24 mm(L) <b>LOADT9</b> - LOCATOR Abutment Driver Tip 30 mm(L) <b>RASH4</b> - Right Angle Driver Tip 0.050 inches Hex 24 mm <b>RASH9</b> - Right Angle Driver Tip 0.050 inches Hex 24 mm
IMLOA00x	Certain LOCATOR Abutment 3.4 mm(D)			
SCRNBax	LDA Screw NobelActive®	35 Ncm Per Original Manufacturer's Recommendation	These threaded devices require a driver(s), driver tip(s) and other instrumentation not manufactured or sold by Zimmer Biomet. Please refer to the original equipment manufacturer for instrumentation and indications.	
SCRNBSx	LDA Screw NobelReplace®			
SCRsBLx	LDA Screw Straumann® Bone-Level			



## Torque Matrix — External Hex Connection

Please use the table below as a guide for which Drivers and Driver Tips must be used with Zimmer Biomet External Hex threaded devices. (e.g. screws and abutments), as well as the recommended torque values for each.

Recommended Torque Matrix – External Connection				
Threaded Devices		Recommended Torque Values	Drivers	Driver Tips
MMCxx	Implant Mount	Hand Tighten	<b>PHD02N</b> - Narrow Posterior Large Hex Driver 17 mm(L) <b>PHD03N</b> - Narrow Posterior Large Hex Driver 24 mm(L)	N/A
WSKxx	Waxing Screw/Guide Pin-Knurled			
MUNITS	Square Try-In Screw	Hand Tighten	<b>PSQD0N</b> - Narrow Posterior Square Driver 17 mm(L) <b>PSQD1N</b> - Narrow Posterior Square Driver 24 mm(L)	N/A
UNITS	Universal Try-In Screw Square Driver			
GSxxx	Gold Slotted Screw	10 Ncm	<b>PSD00</b> - Posterior Screw Driver 17 mm <b>PSD01</b> - Standard Screw Driver 24 mm	<b>RASD1</b> - Right Angle Slotted Driver Tip, 24 mm(L) <b>RASD6</b> - Right Angle Slotted Driver Tip, 30 mm(L)
CS275	Cover Screw, Headless	10 Ncm	<b>PHD00N</b> - Narrow Posterior Hex Driver 17 mm <b>PHD01N</b> - Narrow Standard Hex Driver 24 mm	<b>RASH2N</b> - Narrow Right Angle Small Hex Driver Tip 24 mm <b>RASH7N</b> - Narrow Right Angle Small Hex Driver Tip 30 mm
CS375	Cover Screw - Implant 4.1 mm(D)			
CSx00	Cover Screw - Implant			
MMCS1	Implant Cover Screw 3.4 mm(D)			
EHAxxx	BellaTek® Encode® Healing Abutment	20 Ncm	<b>PHD02N</b> - Narrow Posterior Large Hex Driver 17 mm(L) <b>PHD03N</b> - Narrow Posterior Large Hex Driver 24 m(L)	<b>RASH3N</b> - Narrow Right Angle Large Driver Tip (Hexed) 24 mm(L) <b>RASH8N</b> - Narrow Right Angle Large Driver Tip (Hexed) 30 mm(L)
LPACxxxx	Low Profile Angled Abutment			
MHA3x	EP® Healing Abutment 3.4 mm(D)			
THAxx	EP Healing Abutment 4.1 mm(D)			
WTH5xx	EP Healing Abutment 5 mm(D)			
WTH6xx	EP Healing Abutment 6 mm(D)			
UNIHG	Gold-Tite® Hexed Uniscrew			
UNIHT	Titanium Hexed Uniscrew			
THRCx	Temporary Healing Retention Cylinder			



# Implant and Abutment System Connections

## Certain Internal Connection

The internal connection aspect of the implant and abutment are designed for ease of use and simplicity.

**QuickSeat Connection: It Clicks!** The Certain Implant and Abutment Systems feature the QuickSeat Connection. This unique connection produces an audible and tactile “click” that confirms placement of Impression Copings and Abutments.



Abutment fingers cause the “click” and also provide retention for the prosthetic components in the implant before the screw is placed. A screw is needed to fully seat the components when the restoration is being tried in or definitively placed.

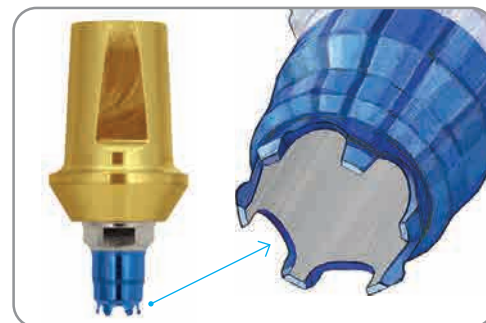

The 6/12 hex inside the internal connection incorporates both a 6-point single and a 12-point double hex. The 6-point single hex is designed for two functions: engaging the driver tip for mountless delivery during implant placement and providing anti-rotation for all straight abutments.

The 12-point double hex is designed to provide 30° rotational positioning for pre-angled abutments.

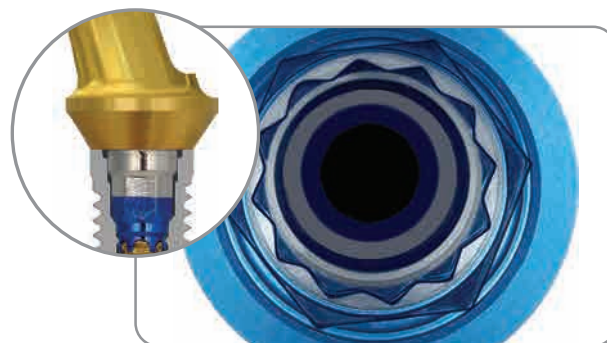

**Impression Copings:** Pick-Up and Twist Lock Transfer Copings are available in the Certain Internal Connection design, in three Emergence Profile (EP<sup>®</sup>) diameters and a straight diameter to match the corresponding Healing Abutment. The Impression Copings also “click” when completely seated. These copings have a different finger design that engages 2 mm internally into the implant, as compared to the abutment’s design that engages 4 mm deep into the implant. This shorter engagement into the implant is important because it aims to allow off-axis draw for implant impressions that are divergent.



 3.4 mm     4.1 mm     5.0 mm     6.0 mm

**Color-Coding:** Certain Implants and all interfacing components are color-coded by restorative platform diameter for easy identification and selection.

## External Hex Connection

The external hex connection implant and abutment designs have been widely used in implant dentistry.

Gold Standard ZR [Zero Rotation] is a proprietary design incorporating machined microstops within the corners of the hex in the abutment. The design aims to reduce horizontal rotation between the implant and abutment. Gold Standard ZR is available on UCLA, GingiHue and Conical Abutments.

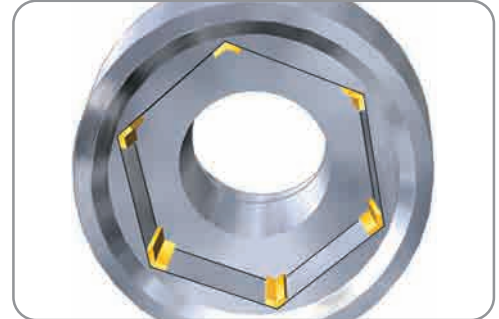

The 12-point double hex, which is machined in the 15° Pre-Angled GingiHue Abutment, provides rotational positioning in 30° increments on the implant hex.

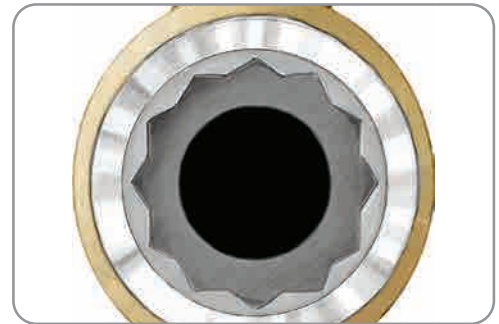

**Precise Abutment Placement:** The ASYST Abutment Placement Tool provides fingertip control for fast and easy abutment delivery. The proprietary packaging design makes abutment placement easier because the abutment is delivered sterile from the package directly to the implant site. The abutment and abutment screw are packaged inside the plastic ASYST seating device. The plastic seating device is designed to facilitate precise placement of the abutment onto the implant. The ASYST Tool is packaged with Low Profile, Standard and Conical Abutments.



**Impression Copings:** Pick-Up and Twist Lock Transfer Copings are available in both the external connection design in three Emergence Profile (EP) diameters and a straight diameter to match the corresponding healing abutment. The proprietary Twist Lock design provides an accurate transfer of the implant connection. This unique Twist Lock feature provides a series of undercuts to guide the coping into the impression, giving stability to the impression coping/analog prior to pouring the impression. As a result, the copings lock into orientation grooves upon clockwise rotation, thereby allowing for a tactile sensation of resistance that should ensure an accurate hex transfer.

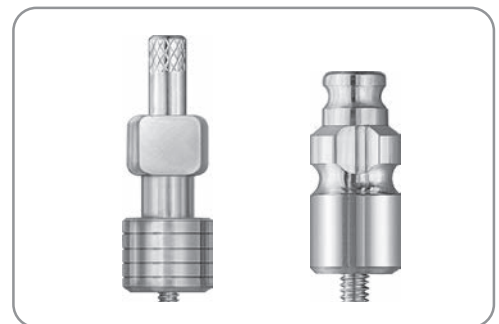

## Certain QuickSeat Activator Tool

The Certain QuickSeat Activator Tool is used to verify that the fingers on impression copings and abutments are in the proper position for proper retention when placed into the implant [Fig. 1].

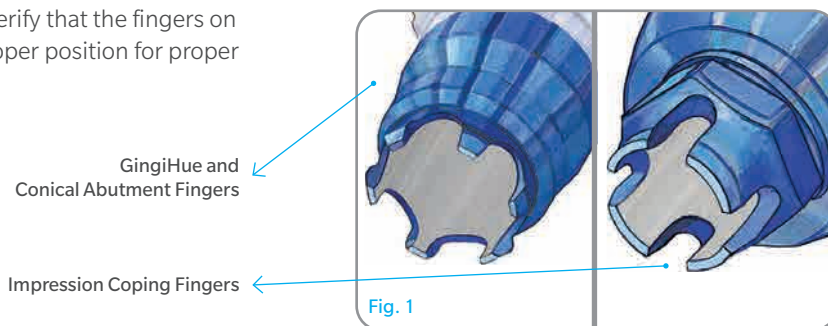

The Certain QuickSeat Activator Tool is marked on both sides to indicate impression coping activation or abutment activation.

To activate the Certain QuickSeat fingers, locate the proper end for the component.

- **Impression Copings:**  
Insert the impression coping onto the pin, fingers first and slide inward until the fingers meet the tool [Fig. 2].
- **Abutments:**  
Insert the abutment onto the pin, fingers first and slide inward until the platform meets the tool [Fig. 3].

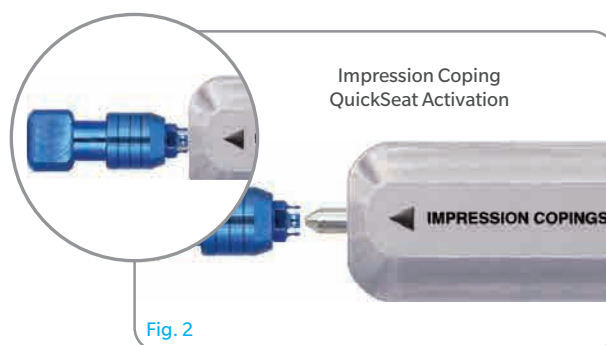

Remove the component from the pin and insert it into the implant.

In addition, there is an area indicated on the tool for deactivating the fingers on a Hexed UCLA Cylinder [Fig. 4]. This may be necessary during waxing, finishing or porcelain application when laboratory technicians prefer to insert and remove the abutment from the analog without finger retention. After the custom abutment or crown is completed, the UCLA fingers must be reactivated [Fig. 5].

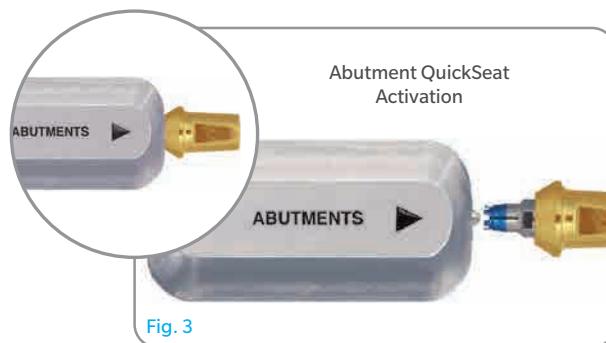

UCLA Cylinder QuickSeat Deactivation



UCLA Cylinder QuickSeat Activation

## Certain Hexed and Non-Hexed Pick-Up Impression Coping Draw Angles

### Maximum Draw of Certain Hexed Pick-Up Impression Copings

Certain Hexed Pick-Up Impression Copings are designed with a shallow internal connection and a draft on the hex, which allows these to draw from implants placed at divergent angles to a maximum of 30° per implant. This maximum angulation is possible with individual or multiple copings that are not rigidly splinted together before the impression is made [Fig. 1].



Fig. 1  
30° Per Implant

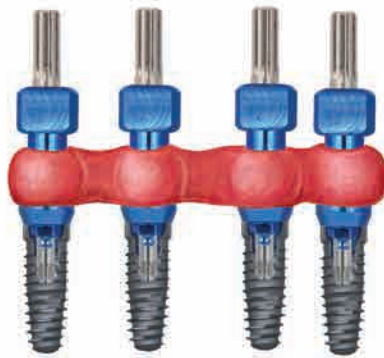

Fig. 2  
Pick-Up Impression Copings Rigidly Splinted (Parallel Implants)

### Maximum Draw of Certain Hexed Pick-Up Impression Copings and Non-Hexed Pick-Up Impression Copings When Rigidly Splinted Together

Clinicians may desire to rigidly splint the Pick-Up Impression Copings together prior to impressing a multiple-implant, implant level restoration. The Hexed Pick-Up Impression Copings will not draw from multiple divergent implants when rigidly splinted together. This impression technique may only be used on parallel implants [Fig. 2].

The Non-Hexed Pick-Up Impression Copings have a maximum draw angle of 40° between implants and will draw when rigidly splinted together as impression copings. The Non-Hexed Pick-Up Impression Copings have a shallow non-hex engaging internal connection that allows up to 40° of draw [Fig. 3].



Fig. 3  
40° Divergence Between Splinted Implants

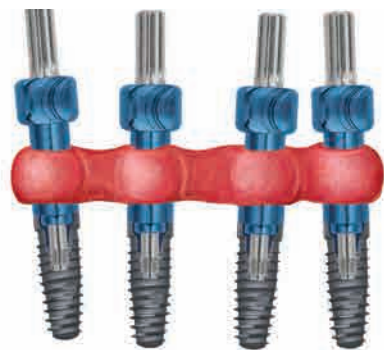

Fig. 4  
Non-Hexed Pick-Up Impression Copings Rigidly Splinted (Non-Parallel Implants)

When clinicians desire to splint the impression copings together before making an impression of multiple divergent implants for a splinted implant restoration, the Non-Hexed Pick-Up Impression Copings should be used in place of the Hexed Pick-Up Impression Copings [Fig. 4].



## Certain Hexed and Non-Hexed Pick-Up Impression Coping Draw Angles

The Certain Internal Connection line of restorative components includes UCLA Abutments. This design provides predictability and flexibility for laboratory technicians when waxing and casting implant-level restorations relative to conventional prefabricated abutments.

- **Cylinder Retention Design:**

The cylinder retention design incorporates machined vertical grooves that aim to reduce the potential for miscasts due to the smoother alloy flow onto the gold alloy cylinder during casting. The vertical grooves provide mechanical retention for the alloy by stopping on the horizontal retention instead of flowing to the margin [Fig. 1].

- **Chamfer Margin:**

The chamfer margin design provides a smooth transition from the gold alloy cylinder to the cast alloy at the junction of the two metals. It also aims to aid in preventing the alloy from flowing onto the implant restorative platform of the gold alloy cylinder during casting [Fig. 1].

- **Collar Height:**

The collar height is 0.25 mm to provide flexibility when fabricating restorations for implants with shallow tissue depths. This allows the restoration to emerge from the implant platform and to add porcelain closer to the implant platform on screw-retained restorations [Fig. 1].

- **Collar Adjustment After Casting:**

The 0.25mm collar height may cause an undercut laterally around the implant platform. The undercut should be removed after casting by tapering the collar back [Fig. 3].

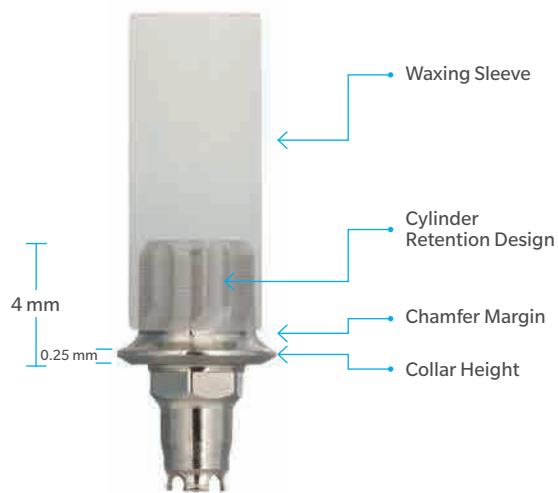

Fig. 1  
Certain UCLA Abutment

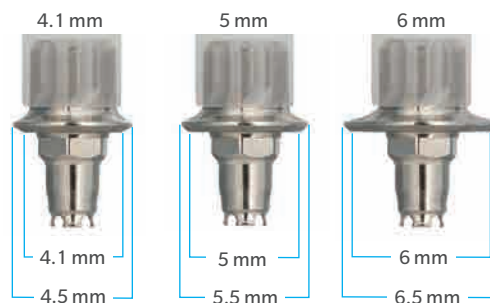

Fig. 2  
Certain UCLA Abutment Collar Diameter



Fig. 3  
Certain UCLA Abutments Collar Adjustments After Casting

### Certain Non-Hexed Abutments

The Certain Non-hexed Abutments are designed to provide flexibility for laboratory technicians when fabricating splinted multiple-unit, screw-retained provisional restorations, as well as bridge frameworks and bars for implant level restorations.

- Internal Engagement**  
 Non-hexed abutments have a 1 mm internal engagement feature to allow a greater degree of draw from multiple divergent implants than other internal connection implant systems [Fig. 1].
- Large Diameter Abutment Screw**  
 Non-hexed abutments are retained on the implants with a unique Large Diameter Gold-Tite® or Titanium Abutment Screw. The larger diameter screws provide lateral stability to the restoration. It goes into the full depth of the internal connection, replacing the 4 mm length of the hexed abutment’s connection [Fig. 1].
- Maximum Draw of Non-Hexed Abutments**  
 Non-hexed abutments have a maximum draw angle of 40° between implants [Fig. 2].
- Gold Alloy Cylinder Formulation**  
 The formulation defines the melting temperatures for the gold alloy cylinder which is to be considered during burnout and casting procedures. Detailed formulation values are indicated below [Fig. 3].

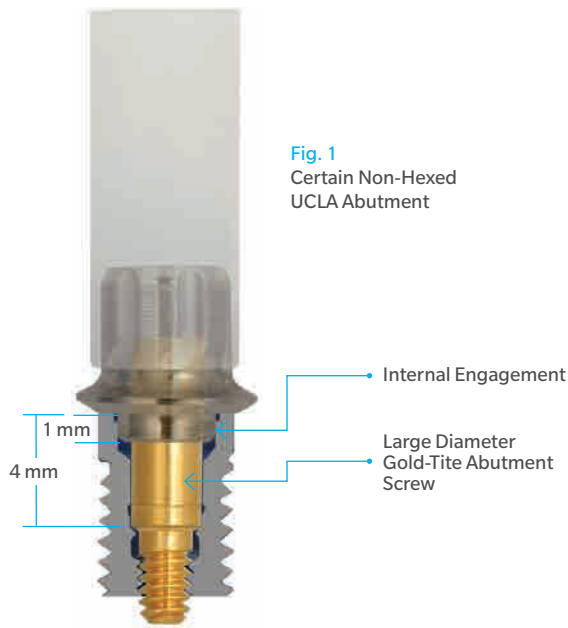

Fig. 1  
Certain Non-Hexed  
UCLA Abutment



Fig. 2  
40° Divergence Between  
Splinted Implants

	Fahrenheit	Celsius
Melting Range	2552 – 2732°F	1400–1500°C
Solidus	2552 – 2579°F	1400–1415°C
Liquidus	2714 – 2732°F	1490–1500°C
CTE	12.2 x 10-6 °K at 932°F	12.2 x 10-6 °K at 500° C

Fig. 3  
Gold Alloy Cylinder Melting Temperatures

## Abutment Selection Guide

### Restorative Dentist

-  Select the proper abutment size by matching it to the Emergence Profile (EP) and the restorative platform of the healing abutment and the implant platform diameter. The restorative and implant platform diameter is identified by the color anodized on the implants and components (see below).

3.4 mm    
  4.1 mm    
  5.0 mm    
  6.0 mm

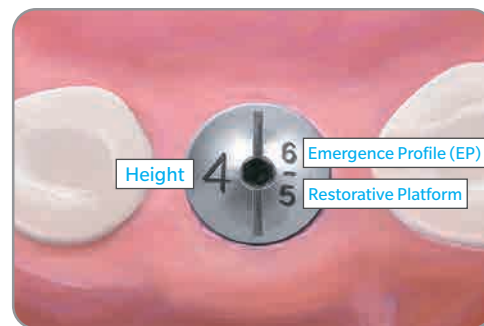

-  Select the proper abutment collar height by measuring the height of the healing abutment above the tissue on the buccal surface, **not** including the domed portion. Subtract this measurement from the total height of the healing abutment.



-  Evaluate angulation by inserting a .048" Large Hex Driver [PHD02N or PHD03N] into the healing abutment. To help prevent accidental swallowing, thread floss through the spinner of the driver. If the angle appears to be more than 10°, use the Prosthetic Angle Guide Kit to determine the approximate angulation of the implant. This kit consists of 15, 25 and 35° guide pins in 2, 4 and 6 mm collar heights. To use angled guides, healing abutments must be removed from the implants.

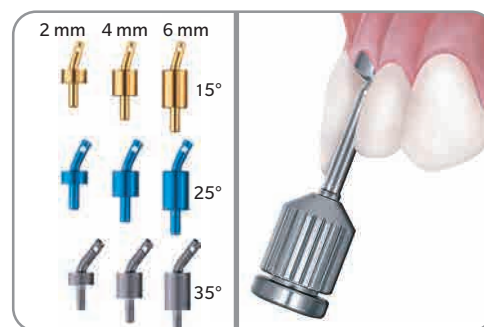

-  Place the guide pins into the implant to select the proper angled abutment. To help prevent accidental swallowing, thread floss through the hole of the Prosthetic Angle Guide. The correct angle will have the guide pin in line with the central fossa of the adjacent posterior teeth or the incisal line angle of the adjacent anterior teeth.

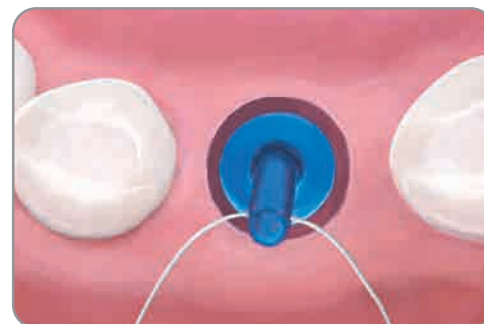

## Cement-Retained Restorations

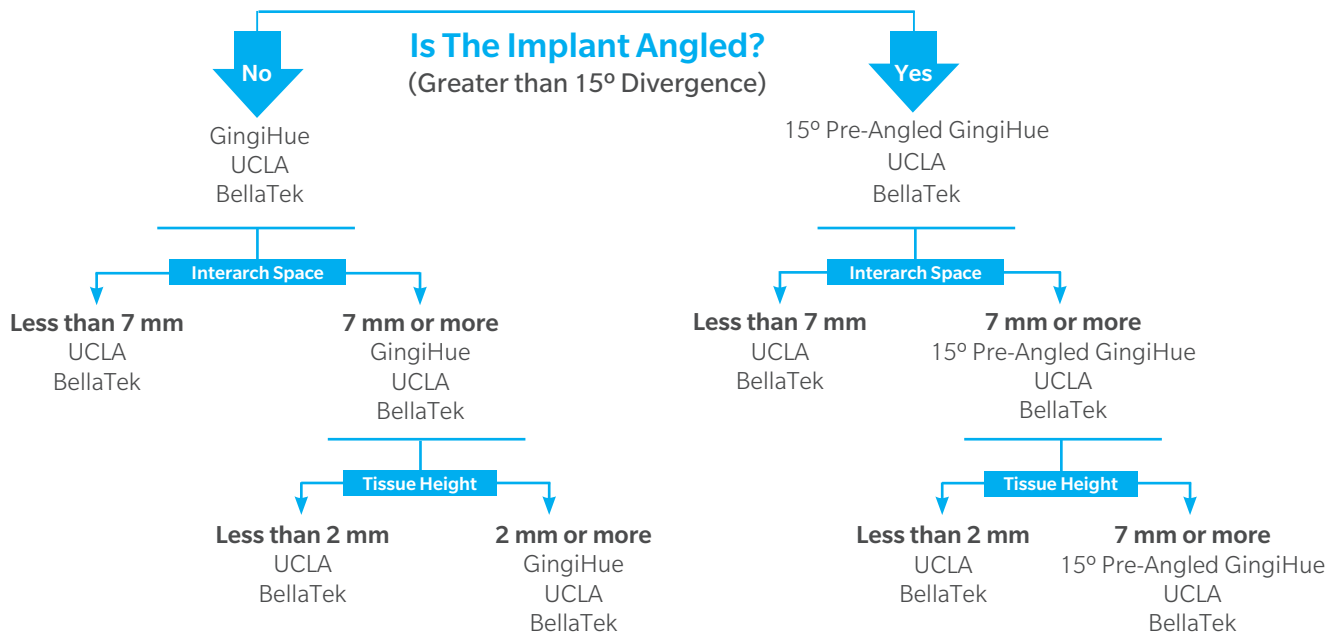

Is the implant centered in the tooth site?  
If the answer is no, UCLA is the best option with in the Zimmer Biomet portfolio.

## Screw-Retained Restorations

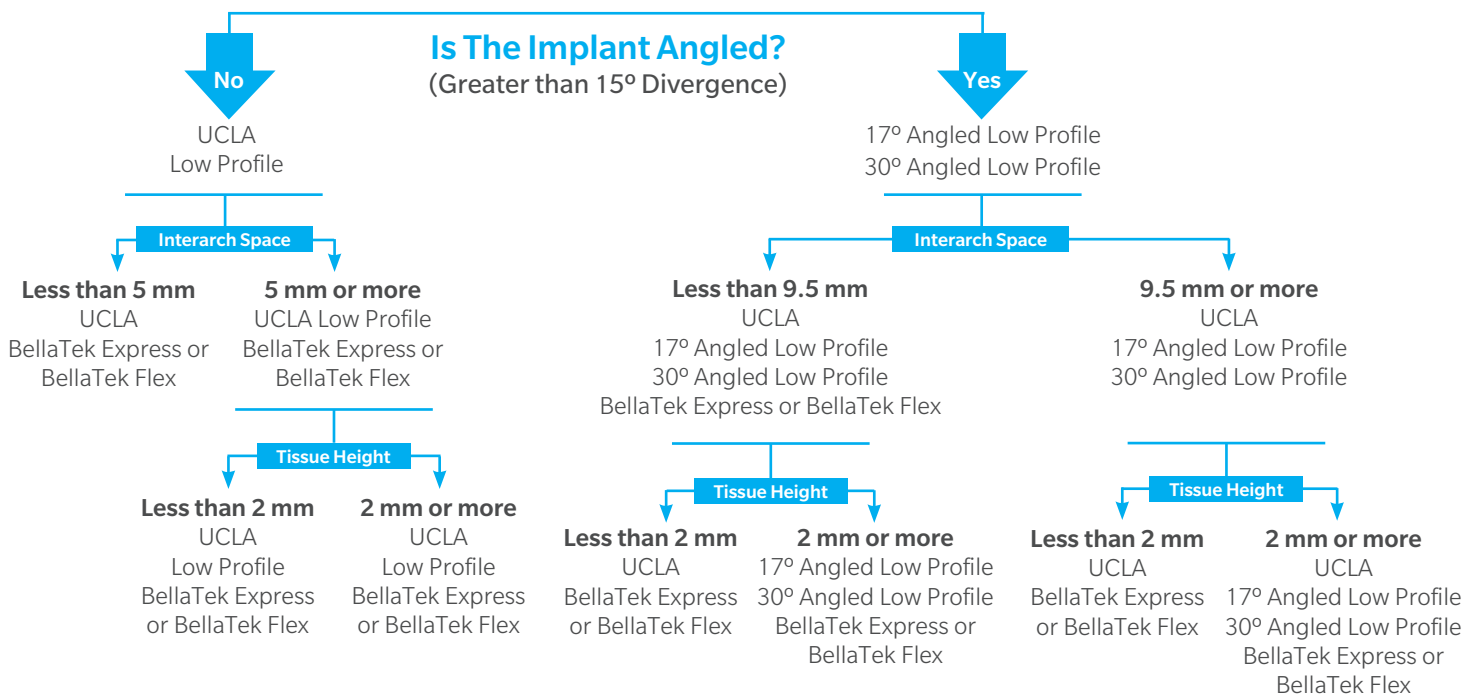

Is the implant centered in the tooth site?  
If the answer is no, UCLA is the best option with in the Zimmer Biomet portfolio.

# Implant and Abutment Level Impressions

## How to Choose a Coping

### Choices

#### Pick-Up Impression Coping (Open Tray)

The Pick-Up Impression Coping transfers the position of an implant hex to a laboratory cast. The coping is picked up inside the impression when the impression is removed from the mouth. An open impression tray is used with the Pick-Up Impression Coping.

#### NOTE:

- Pick-Up Impression Copings may be difficult to use in limited, interarch distance spaces.
- Pick-Up Impression Copings are ideal for use when an impression is made of multiple divergent implants (see page 14).

#### Twist Lock Transfer Coping (Closed Tray)

The Twist Lock Transfer Coping transfers the position of an implant hex to a laboratory cast. The coping is designed to remain on the implant when the impression is removed from the mouth. The coping is then removed from the implant, an implant analog is seated into the hex connection and the impression coping/analog assembly is seated into the impression.

#### NOTE:

- Twist Lock Impression Copings are ideal for use in limited, interarch spaces.
- Twist Lock Impression Copings are contraindicated for use when an impression is made of multiple divergent implants. There is a risk of not being able to remove the impression tray from the copings once the impression material has set.

## Selecting The Proper Impression Coping

Select the proper platform diameter Pick-Up or Twist Lock Transfer Impression Coping by matching it to the implant platform color. Also, match the diameter of the impression coping to the Emergence Profile (EP) diameter of the healing abutment. See healing abutment measurements:

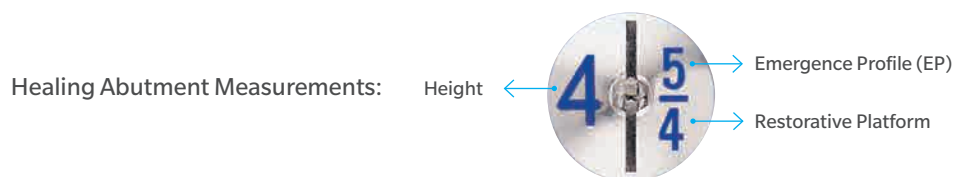

If using the Pick-Up Impression Coping, turn to page 14.

If using the Twist Lock Transfer Impression Coping, turn to page 21.

### Components Needed

- Matching platform and EP diameter Pick-Up or Twist Lock Impression Coping(s).
- Matching implant laboratory analog(s).



### Instruments Needed

- PHD02N or PHD03N - .048" Large Hexed Driver
- ICD00 - Impression Coping Driver (For Twist Lock Only).

## Pick-Up Impression Copings



(Certain Internal Connection System is Illustrated)

### Restorative Dentist

1.   Select the proper Pick-Up Impression Coping by matching the Emergence Profile (EP) diameter of the healing abutment and the restorative platform. To determine the restorative and implant platform diameter, see below. Remove the healing abutment from the implant using a .048" Large Hex Driver [[PHD02N](#) or [PHD03N](#)]. To help prevent accidental swallowing, thread floss through the spinner of the driver.



 3.4 mm   
  4.1 mm   
  5.0 mm   
  6.0 mm





2.   Activate the coping fingers using the Certain QuickSeat Activator Tool (see page 11). Place the coping into the implant, line up the hex and press firmly until hearing and feeling an audible and tactile click.

Or



 Place the coping onto the implant, engaging the hex.

  Thread an impression coping screw into the implant and finger-tighten using the .048" Large Hex Driver [[PHD02N](#) or [PHD03N](#)]. To help prevent accidental swallowing, thread floss through the spinner of the driver.

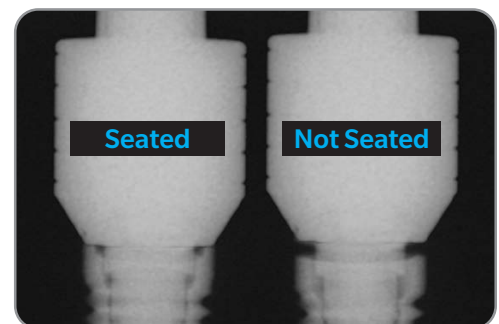

3.   Radiograph the interface to verify complete seating of the coping on the implant. Place the film perpendicular to the interface of the coping on the implant or abutment.



4.   A custom or stock **open** top impression tray is used for the Pick-Up Impression Technique. Cut a small hole into the tray so that the clinician has access to the screw head.



5.  Medium or heavy viscosity impression material is recommended for the impression material in the impression tray.

Syringe light viscosity impression material around the entire coping.



6.  Load the impression tray and seat it in the mouth. Wipe impression material off the top of the screw so that the screw hex is visible and free of impression material before it sets. Allow the impression material to set per the manufacturer's instructions.





7.  After the impression material has set, unscrew and remove the coping screw using a .048" Large Hex Driver [PHD02N or PHD03N]. To help prevent accidental swallowing, thread floss through the spinner of the driver. Remove the impression from the mouth.





8.  Visually verify that the impression material has completely adapted around the coping and that there is no impression material on the impression coping's restorative platform.



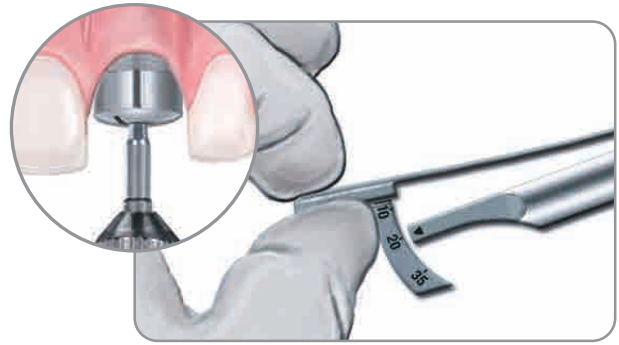

9.   Immediately replace the healing abutment back onto the implant and torque to 20 Ncm using a .048" Large Hex Driver Tip [RASH3N or RASH8N] with a torque device [L-TIRW or HTD-C].



#### Laboratory

10.   Place the proper diameter implant analog onto the impression coping, engaging the hex. Hold the analog in place while finger-tightening the screw with a .048" Large Hex Driver [PHD02N or PHD03N]. Visually verify that the analog is completely seated on the impression coping. If the clinician is sending the impression to a commercial laboratory, do not attach the analogs.



11.   Syringe soft-tissue material around the coping/analog interface. Pour the cast in die stone. Articulate with the opposing cast.

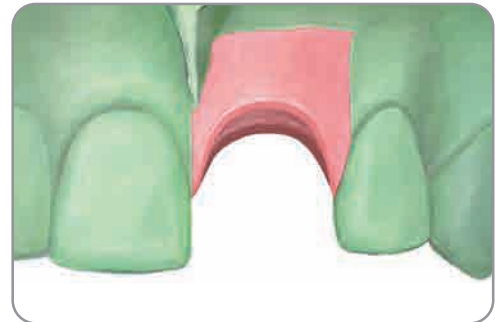





## Twist Lock™ Transfer Impression Copings



(External Connection is Illustrated)

### Restorative Dentist



1.   Select the proper Twist Lock Transfer Impression Coping by matching the Emergence Profile (EP) diameter of the healing abutment and the restorative platform. To determine the restorative and implant platform diameter, see below. Remove the healing abutment from the implant using a .048" Large Hex Driver [[PHD02N](#) or [PHD03N](#)]. To help prevent accidental swallowing, thread floss through the spinner of the driver.

 3.4 mm   
  4.1 mm   
  5.0 mm   
  6.0 mm





2.   Activate the coping fingers using the Certain QuickSeat Activator Tool (see page 11). Place the coping into the implant, line up the hex and press firmly until hearing and feeling an audible and tactile click.



Or

-  Place the coping onto the implant, engaging the hex.
-   Thread the coping screw into the implant and finger-tighten using an Impression Coping Driver [[ICD00](#)].

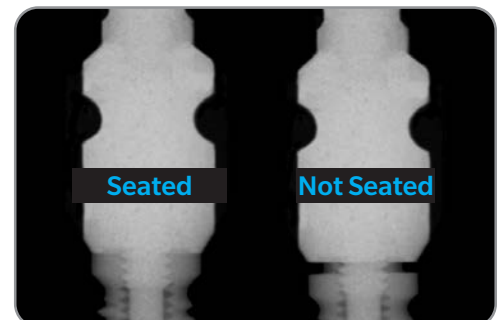

3.   Radiograph the interface to verify complete seating of the coping on the implant. Place the film perpendicular to the interface of the coping on the implant or abutment.



4.   A custom or stock impression tray is used for the Twist Lock Transfer Impression technique. Try in the tray to verify that there is no contact with the coping.

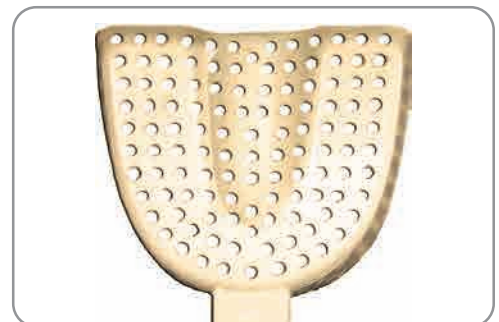



5.  Medium or heavy viscosity impression material is recommended for the impression material in the impression tray.

Syringe light viscosity impression material around the entire coping.

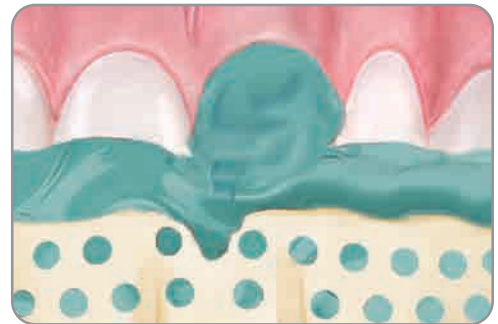

6.  Load the impression tray and seat it in the mouth. Allow the impression material to set per the manufacturer's instructions.





7.  After the impression material has set, remove the impression from the mouth. The coping will remain on the implant. Visually verify that the impression material has completely adapted around the coping.





8.  Loosen the Twist Lock Impression Coping Screw from the implant using the Impression Coping Driver [ICD00]. Then remove the Twist Lock Impression Coping from the implant.



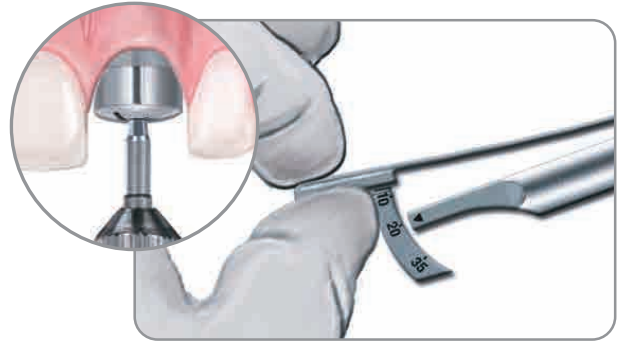

9.   Immediately replace the healing abutment back onto the implant and torque to 20 Ncm using a .048" Large Hex Driver Tip [RASH3N or RASH8N] with a torque device [L-TIRW or HTD-C].



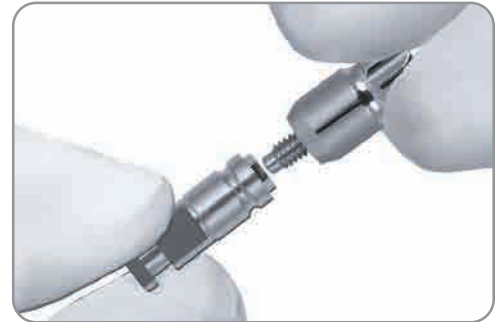

#### Laboratory

10.   Place the proper diameter implant analog onto the impression coping, engaging the hex. Hold the components together and finger-tighten the screw. Visually verify that the impression coping is completely seated on the implant analog.

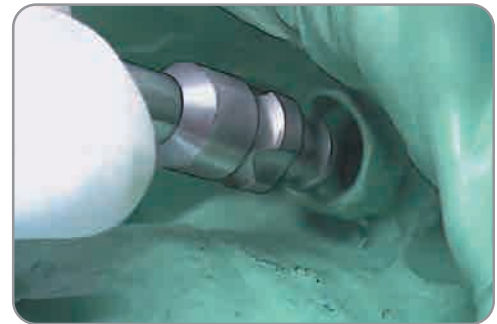

11.   Re-index the impression coping/analog assembly into the impression using firm pressure to its full depth. Slightly rotate the coping/analog clockwise until feeling anti-rotational resistance. This indicates that the orientation grooves are locked into place and the implant hex is accurately transferred.



12.   Syringe soft-tissue material around the coping/analog interface. Pour the cast in die stone. Articulate with the opposing cast.

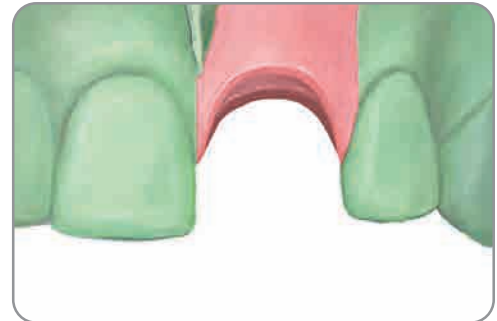

# Cement-Retained Restorations

## PreFormance® Posts

### Considerations:

- Single- and multiple-unit cement-retained provisional restorations
- Minimum interarch space of 7 mm
- Maximum angulation of 15°
- Intraoral use limited to 180 days
- Immediate non-occlusal loading of single-unit provisional restorations
- Multiple-unit restorations will require an evaluation of occlusal forces in lateral and protrusive excursions and masticatory forces to minimize the load on the provisional restorations
- Guided soft-tissue healing of single- and multiple-unit restorations of integrated implants

### Specifications:

- PEEK; Titanium Alloy Connection

### Instrumentation Needed:

- Hexed Titanium Screw [IUNIHT or UNIHT]
- .048" Large Hex Driver [PHD02N or PHD03N]
- Laboratory Abutment Holder [ILTAH57, LTAH5, LTAH7]
- .048" Large Hex Driver Tip [RASH3N or RASH8N]
- Torque Device [L-TIRW or HTD-C]

## PreFormance Post | Indirect Technique

### Restorative Dentist

1.  Follow the steps for implant level impressions on pages 18-20 for the Pick-Up Technique and pages 21-23 for the Twist Lock Transfer Technique.



### Laboratory

2.  Select the proper PreFormance Provisional Post with the desired Emergence Profile (EP) diameter and collar height by measuring the interproximal tissue heights and select a collar height that can be prepared to follow the gingival contour. Match the color to the implant platform.

 Place the post into the implant analog, line up the hex and press firmly until hearing and feeling an audible and tactile click.

Or

 Place the post onto the implant analog, engaging the hex.



 Thread a Hexed Titanium Screw [[JUNIHT](#) or [UNIHT](#)] into the implant analog and finger-tighten using a .048" Large Hex Driver [[PHD02N](#) or [PHD03N](#)]. Mark the post with a pencil to areas requiring preparation.



3.  Prepare the post in areas marked to the desired depth using a carbide bur. Refine with a coarse diamond bur. Prepare margins to 1 mm subgingival or following the gingival margins according to fixed prosthodontic principles. The post can be prepared on the cast or removed and placed on a Laboratory Abutment Holder [[LTAH57](#), [LTAH5](#), [LTAH7](#)]. Maintain three walls of the abutment and at least .5 mm of wall thickness during preparation.

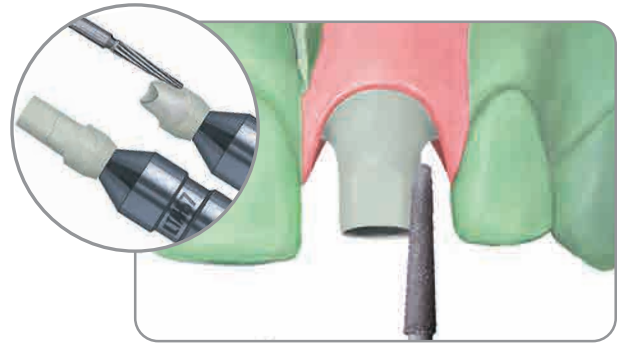

4.  Block out the screw access opening with wax. Fabricate the provisional crown on the prepared post using the provisional material of choice.



#### Restorative Dentist

5.  Remove the healing abutment from the implant using a .048" Large Hex Driver [[PHD02N](#) or [PHD03N](#)]. To help prevent accidental swallowing, thread floss through the spinner of the driver.

 Activate the PreFormance Provisional Post fingers using the Certain QuickSeat Activator Tool (see page 11). Place the prepared post into the implant, line up the hex and press firmly until hearing and feeling an audible and tactile click.

Or

 Place the prepared post onto the implant, engaging the hex.



Thread a Hexed Titanium Screw [[JUNIHT](#) or [UNIHT](#)] into the implant and finger-tighten using the .048" Large Hex Driver [[PHD02N](#) or [PHD03N](#)]. To help prevent accidental swallowing, thread floss through the spinner of the driver.

**NOTE:** The abutment should be placed in the same position as it was prepared on the cast. A dimple on the facial surface guides clinicians with accurate placement.

6.  Try the provisional crown on the post and check the interproximal contacts, marginal fit and occlusion.

Remove the provisional crown. Torque the screw to 20 Ncm using a .048" Large Hex Driver Tip [RASH3N or RASH8N] with a torque device [L-TIRW or HTD-C].



7.  Place protective material into the screw access opening. Seal the access opening with temporary filling material. Cement the crown to the post using temporary cement. Remove any excess cement.



When using PreFormance Provisional Posts in immediate non-occlusal loading protocols for multiple-units, please follow these instructions:



- Do not splint to natural dentition.
- If splinting to other integrated implants, all lateral and centric contacts should be eliminated. The restoration should be completely out of occlusion. Masticatory contacts on the recently placed implants should be minimized/eliminated. Dietary restrictions and compliance are critical for success in these types of cases.
- If splinting to other immediately placed implants, no occlusion and a soft diet should be recommended to the patient for six to eight weeks.

## PreFormance Post | Direct Technique

(See page 24 for considerations and specifications)



### Restorative Dentist



1.   Select the proper PreFormance Provisional Post with the desired Emergence Profile (EP) diameter and collar height by measuring the interproximal tissue heights and select a collar height that can be prepared to follow the gingival contour. Match the color to the implant platform.



  Activate the PreFormance Provisional Post fingers using the Certain QuickSeat Activator Tool (see page 11). Place the post into the implant, line up the hex and press firmly until hearing and feeling an audible and tactile click.

Or



  Place the post onto the implant, engaging the hex.

  Thread a Hexed Titanium Screw [[IUNIHT](#) or [UNIHT](#)] into the implant and finger-tighten using a .048" Large Hex Driver [[PHD02N](#) or [PHD03N](#)]. To help prevent accidental swallowing, thread floss through the spinner of the driver. Mark the post with a pencil to areas requiring preparation.

2.   Prepare the post in areas marked using a high-speed handpiece, carbide bur and irrigation. Refine with a coarse diamond bur. Prepare margins to 1 mm subgingival or according to fixed prosthodontic principles, following the gingival contours. The post can be prepared intraorally or removed and placed on a Laboratory Abutment Holder [[ILTAH57](#), [LTAH5](#), [LTAH7](#)]. Maintain three walls of the abutment and at least .5 mm of wall thickness during preparation.

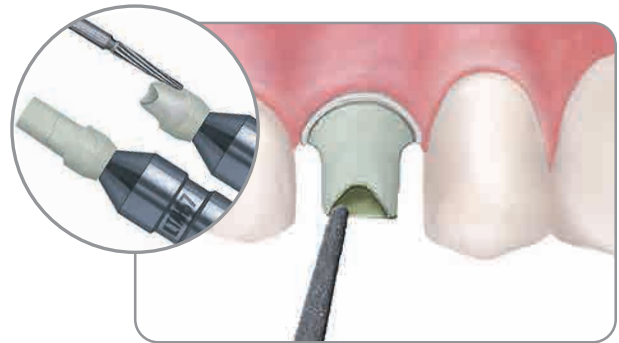
3.   Once abutment preparation is complete, secure the abutment to the implant using a Hexed Titanium Screw [[IUNIHT](#) or [UNIHT](#)] and torque to 20 Ncm using a .048" Large Hex Driver Tip [[RASH3N](#) or [RASH8N](#)] with a torque device [[L-TIRW](#) or [HTD-C](#)].



4.   Place protective material into the screw access opening. Seal the access opening with temporary filling material. Fabricate a provisional crown on the post and cement it in place using temporary cement. Remove any excess cement. Make any necessary occlusal adjustments. For easier occlusal adjustments, the prosthesis should be polished outside of the mouth prior to cementation.

When using PreFormance Provisional Posts in immediate non-occlusal loading protocols for multiple-units, please follow these instructions:

- Do not splint to natural dentition.
- If splinting to other integrated implants, all lateral and centric contacts should be eliminated. The restoration should be completely out of occlusion. Masticatory contacts on the recently placed implants should be minimized/eliminated. Dietary restrictions and compliance are critical for success in these types of cases.
- If splinting to other immediately placed implants, no occlusion and a soft diet should be recommended to the patient for six to eight weeks.

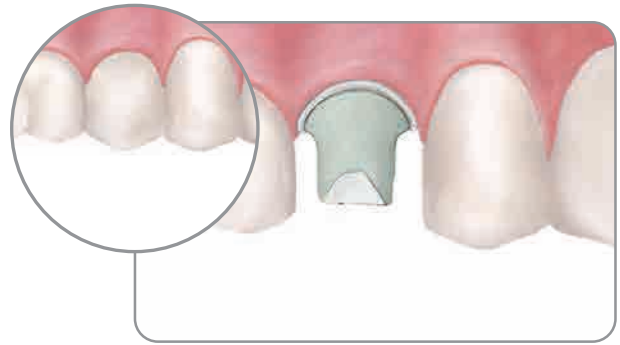





## 15° Pre-Angled PreFormance Post | Indirect Technique



(See page 24 for considerations and specifications)

### Restorative Dentist

1.   Follow the steps for implant level impressions on pages 18-20 for the Pick-Up Technique and pages 21-23 for the Twist Lock Transfer Technique.





### Laboratory

2.   Select the proper 15° Pre-Angled PreFormance Provisional Post with the desired Emergence Profile (EP) diameter and collar height by measuring the interproximal tissue heights and select a collar height that can be prepared to follow the gingival contour. Match it to the implant platform color. The post may be rotated in 30° increments to ideally position it to correct the implant's angulation.



 Place the post into the implant analog, line up the hex in the 12-point double hex and press firmly until hearing and feeling an audible and tactile click.

Or

 Place the post onto the implant analog, engaging the hex.

3.   Thread a Hexed Titanium Screw [[IUNIHT](#) or [UNIHT](#)] into the implant analog and finger-tighten using a .048" Large Hex Driver [[PHD02N](#) or [PHD03N](#)]. Mark the post with a pencil to areas requiring preparation.





4.   Prepare the post using a carbide bur. Refine with a coarse diamond bur. Prepare margins to 1 mm subgingival or according to fixed prosthodontic principles, following the gingival contours. The post can be prepared on the cast or removed and placed on a Laboratory Abutment Holder [[ILTAH57](#), [LTAH5](#), [LTAH7](#)]. Maintain three walls of the abutment and at least .5 mm of wall thickness during preparation.



5.  Fabricate the provisional crown on the prepared post using the provisional material of choice.

#### Restorative Dentist

6.  Remove the healing abutment from the implant using a .048" Large Hex Driver [PHD02N or PHD03N]. To help prevent accidental swallowing, thread floss through the spinner of the driver.

 Activate the 15° Pre-Angled PreFormance Provisional Post fingers using the Certain QuickSeat Activator Tool (see page 11). Place the prepared post into the implant, line up the hex in the 12-point double hex and press firmly until hearing and feeling an audible and tactile click.

Or

 Place the prepared post onto the implant, engaging the hex.

 Thread a Hexed Titanium Screw [IUNIHT or UNIHT] into the implant and finger-tighten using the .048" Large Hex Driver [PHD02N or PHD03N]. To help prevent accidental swallowing, thread floss through the spinner of the driver.

**NOTE:** The post should be placed in the same position as it was prepared on the cast. A dimple on the facial surface guides clinicians with accurate placement.

7.  Try the provisional crown on the post and check the interproximal contacts, marginal fit and occlusion.

Remove the provisional crown. Torque the Hexed Titanium Screw [IUNIHT or UNIHT] to 20 Ncm using a .048" Large Hex Driver Tip [RASH3N or RASH8N] with a torque device [L-TIRW or HTD-C].

8. Place protective material into the screw access opening. Seal the access opening with temporary filling material. Cement the crown to the post using temporary cement. Remove any excess cement.

When using PreFormance Provisional Posts in immediate non-occlusal loading protocols for multiple-units, please follow these instructions:

- Do not splint to natural dentition.
- If splinting to other integrated implants, all lateral and centric contacts should be eliminated. The restoration should be completely out of occlusion. Masticatory contacts on the recently placed implants should be minimized/eliminated. Dietary restrictions and compliance are critical for success in these types of cases.
- If splinting to other immediately placed implants, no occlusion and a soft diet should be recommended to the patient for six to eight weeks.

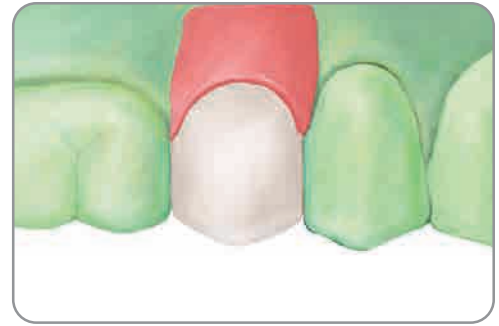

## 15° Pre-Angled PreFormance Post | Direct Technique

(See page 24 for considerations and specifications)

### Restorative Dentist

1.  Select the proper 15° Pre-Angled PreFormance Provisional Post with the desired Emergence Profile (EP) diameter and collar height by measuring the interproximal tissue heights and select a collar height that can be prepared to follow the gingival contour. Match the color to the implant platform.

 Activate the post fingers using the Certain QuickSeat Activator Tool (see page 11). Place the post into the implant, line up the hex in the 12-point double hex and press firmly until hearing and feeling an audible and tactile click. The post may be rotated in 30° increments to ideally position it to correct the implant angulation.

Or

-  Place the post onto the implant, engaging the hex.

Thread a Hexed Titanium Screw [[UNIHT](#) or [UNIHT](#)] into the implant and finger-tighten using a .048" Large Hex Driver [[PHD02N](#) or [PHD03N](#)]. To help prevent accidental swallowing, thread floss through the spinner of the driver. Mark the post with a pencil to areas requiring preparation.



2.  Prepare the post in areas marked using a high speed handpiece, carbide bur and irrigation. Refine with a coarse diamond bur. Prepare margins to 1 mm subgingival or according to fixed prosthodontic principles, following the gingival contours. The post can be prepared intraorally or removed and placed on a Laboratory Abutment Holder [[ILTAH57](#), [LTAH5](#), [LTAH7](#)]. Maintain three walls of the abutment and at least .5 mm of wall thickness during preparation.



3.  Once abutment preparation is complete, screw the post to the implant and torque to 20 Ncm using a .048" Large Hex Driver Tip [[RASH3N](#) or [RASH8N](#)] with a torque device [[L-TIRW](#) or [HTD-C](#)].

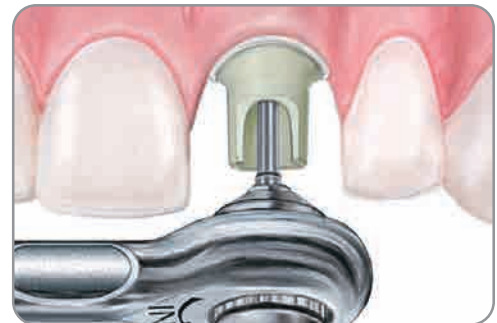

4.  Place protective material into the screw access opening. Seal the access opening with temporary filling material. Fabricate a provisional crown on the post and cement it in place using temporary cement. Remove any excess cement. Make any necessary occlusal adjustments.

When using PreFormance Provisional Posts in immediate non-occlusal loading protocols for multiple-units, please follow these instructions:

- Do not splint to natural dentition.
- If splinting to other integrated implants, all lateral and centric contacts should be eliminated. The restoration should be completely out of occlusion. Masticatory contacts on the recently placed implants should be minimized/eliminated. Dietary restrictions and compliance are critical for success in these types of cases.
- If splinting to other immediately placed implants, no occlusion and a soft diet should be recommended to the patient for six to eight weeks.



## GingiHue® Posts

### Considerations:

- Single and multiple-unit porcelain- fused-to-metal restorations
- Areas of thin labial tissue where gingival discoloration is possible
- Preparable to follow gingival contours
- Conventional crown and bridge procedures
- Maximum angulation correction of 15°
- Minimum interarch space of 7 mm

### Specifications:

- Titanium Alloy (Certain Straight Posts and all 15° Pre-Angled Posts)
- Commercially Pure Titanium (External Hex Straight Posts)

### Instrumentation Needed:

- Screw [MUNITS, IUNITS or UNITS]
- .048" Large Hex Driver [PHD02N or PHD03N]
- Square Driver [PSQD0N or PSQD1N]
- Laboratory Abutment Holder [ILTAH57, LTAH5, LTAH7]
- Certain Gold-Tite Hexed Screw [IUNIHG]
- Gold-Tite Square Screw [UNISG]
- .048" Large Hex Driver Tip [RASH3N or RASH8N]
- Torque Device [L-TIRW or HTD-C]
- Square Driver Tip [RASQ3N or RASQ8N]

## GingiHue Post | Indirect Technique

### Restorative Dentist

1.  Follow the steps for implant level impressions on pages 18-20 for the Pick-Up Technique and pages 21-23 for the Twist Lock Transfer Technique.



### Laboratory

2.  Select the proper GingiHue Post by matching it to the Emergence Profile (EP) and the restorative platform of the healing abutment and the implant platform diameter.

Place the post into the implant analog, line up the hex and press firmly until hearing and feeling an audible and tactile click.

Or

-  Place the post onto the implant analog, engaging the hex.

-  Thread a Try-in Screw [MUNITS, IUNITS or UNITS] into the implant analog and finger-tighten using a .048" Large Hex Driver [PHD02N or PHD03N] or a Square Driver [PSQD0N or PSQD1N]. Mark the post with a pencil to areas requiring preparation.

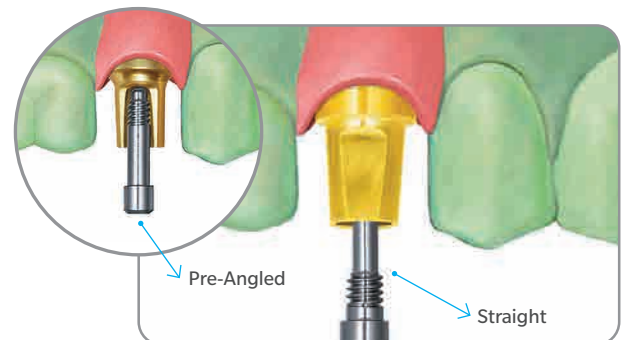

3.  Prepare the post in areas marked using a high-speed handpiece and an aggressive carbide bur. Prepare margins to 1 mm subgingival or according to fixed prosthodontic principles, following the gingival contours. The post can be prepared on the cast or removed and placed on a Laboratory Abutment Holder [[ILTAH57](#), [LTAH5](#), [LTAH7](#)].

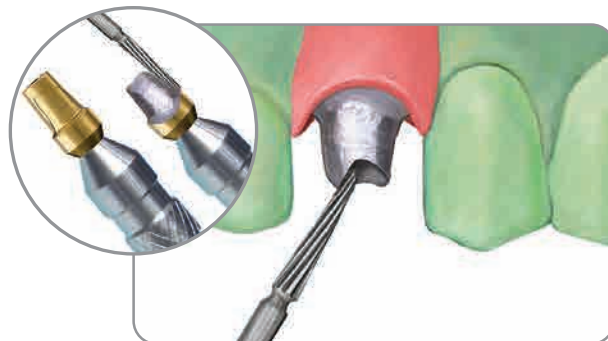

4.  Wax the crown coping on the prepared abutment. Invest, burnout and cast the coping in a low, medium or high noble alloy. Opaque, build porcelain stain and glaze the crown.



#### Restorative Dentist

5.  Remove the healing abutment from the implant using a .048" Large Hex Driver [[PHD02N](#) or [PHD03N](#)]. To help prevent accidental swallowing, thread floss through the spinner of the driver.

 Activate the GingiHue Post fingers using the Certain QuickSeat Activator Tool (see page 11). Place the prepared post into the implant, line up the hex and press firmly until hearing and feeling an audible and tactile click. Thread a Certain Gold-Tite Hexed Screw [[IUNIHG](#)] into the implant and finger-tighten using a .048" Large Hex Driver [[PHD02N](#) or [PHD03N](#)].

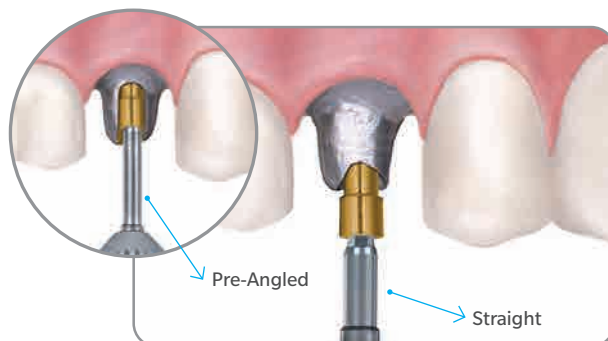



Or

 Place the prepared GingiHue Post onto the implant, engaging the hex. Thread a Gold-Tite Square Screw [[UNISG](#)] into the implant and finger-tighten using a Square Driver [[PSQD0N](#) or [PSQD1N](#)]. To help prevent accidental swallowing, thread floss through the spinner of the driver.

 Radiograph the interface to verify an accurate fit.

#### Restorative Dentist

6.  Try the crown on the Post and check the interproximal contacts, marginal fit and occlusion.

 Torque the Certain Gold-Tite Hexed Screw [[IUNIHG](#)] to 20 Ncm using a .048" Large Hex Driver Tip [[RASH3N](#) or [RASH8N](#)] with a torque device [[L-TIRW](#) or [HTD-C](#)].

Or

 Torque the Gold-Tite Square Screw [[UNISG](#)] to 32-35 Ncm using a Square Driver Tip [[RASQ3N](#) or [RASQ8N](#)] with a torque device [[L-TIRW](#) or [HTD-C](#)].

 Place protective material into the screw access opening. Seal the access opening with temporary filling material. Cement the crown to the post using temporary or permanent cement.





## GingiHue Post | Direct Technique

(See page 33 for considerations and specifications)

### Restorative Dentist

1.  Select the proper GingiHue Post by matching it to the Emergence Profile (EP) and the restorative platform of the healing abutment and the implant platform diameter. Remove the healing abutment from the implants using a .048" Large Hex Driver [PHD02N or PHD03N]. To help prevent accidental swallowing, thread floss through the spinner of the driver.

 Activate the post fingers using the Certain QuickSeat Activator Tool (see page 11). Place the post into the implant, line up the hex and press firmly until hearing and feeling an audible and tactile click.

Or

 Place the post onto the implant, engaging the hex.

 Thread a Try-in Screw [MUNITS, IUNITS or UNITS] into the implant and finger-tighten using the .048" Large Hex Driver [PHD02N or PHD03N] or a Square Driver [PSQD0N or PSQD1N]. To help prevent accidental swallowing, thread floss through the spinner of the driver. Radiograph the interface to verify an accurate fit. Mark the post with a pencil to areas requiring preparation.

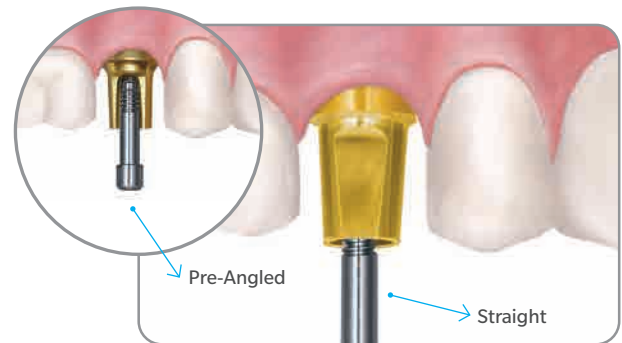

2.  Prepare the post in areas marked using a high-speed handpiece, aggressive carbide bur and irrigation. Prepare margins to 1 mm subgingival or according to fixed prosthodontic principles, following the gingival contours. The post can be prepared intraorally or removed and placed on a Laboratory Abutment Holder [ILTAH57, LTAH5, LTAH7].





3.  Once abutment preparation is complete, replace the try-in screw with a:

 Certain Gold-Tite Hexed Screw [IUNIHG] torqued to 20 Ncm using a .048" Large Hex Driver Tip [RASH3N or RASH8N] with a torque device [L-TIRW or HTD-C].

Or

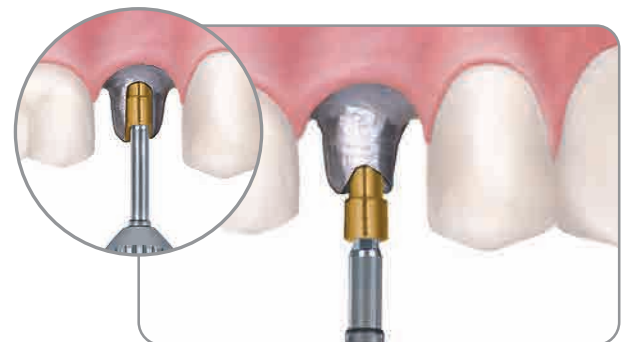
 Gold-Tite Square Screw [UNISG] torqued to 32-35 Ncm using the Square Driver Tip [RASQ3N or RASQ8N] with a torque device [L-TIRW or HTD-C].



- 
 Place protective material into the screw access opening. Seal the access opening with temporary filling material. Place a retraction cord subgingivally to retract the gingiva from the margin prepared on the GingiHue Post. Syringe light viscosity impression material around the abutment post. Load the impression tray with medium or heavy viscosity impression material and seat it in the mouth. Allow the impression material to set per the manufacturer's instructions.

**NOTE:** Placing a retraction cord around implant abutments is typically more difficult than placing a retraction cord around natural teeth.



- 
 Remove the impression. Verify the marginal integrity of the impression.



- 
 Fabricate a provisional crown on the GingiHue Post using conventional fixed prosthodontic techniques and materials. Block out the screw access opening with wax prior to cementing the crown.



- 
 Pour the cast in die stone, pin, section and articulate with the opposing cast.

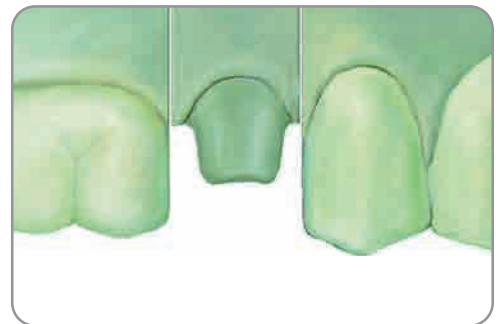



8.  Wax the crown coping on the die. Invest, burnout and cast the coping in a low, medium or high noble alloy. Opaque, build porcelain, stain and glaze the crown.

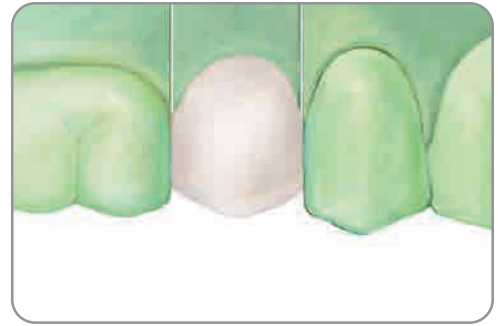

#### Restorative Dentist

1.  Remove the provisional crown from the GingiHue Post and remove all cement. Try the crown on the abutment and check the interproximal contacts, marginal fit and occlusion. Cement the crown to the post using temporary or permanent cement. Remove any excess cement.



## UCLA Abutments

### Considerations:

- Single and multiple-unit cement-retained restorations
- Laboratory fabricated custom abutments
- Minimum interarch space of 6mm
- For aesthetic restorations when tissue is limited
- Maximum angulation correction of 30°

### Specifications:

- Machined Gold Alloy Cylinder With Plastic Unitube

### Instrumentation Needed:

- Screw [MUNITS, IUNITS or UNITS]
- Waxing Screw [IWSU30 or WSU30]
- .048" Large Hex Driver [PHD02N or PHD03N]
- Certain Gold-Tite Hexed Screw [IUNIHG]
- Gold-Tite Square Screw [UNISG]
- Square Driver [PSQD0N or PSQD1N]
- .048" Large Hex Driver Tip [RASH3N or RASH8N]
- Torque Device [L-TIRW or HTD-C]
- Square Driver Tip [RASQ3N or RASQ8N]

## UCLA Abutment | Single-Unit | Indirect Technique

### Restorative Dentist

1.  Follow the steps for implant level impressions on pages 18-20 for the Pick-Up Technique and pages 21-23 for the Twist Lock Transfer Technique.



### Laboratory

2.  Deactivate the fingers of the Certain Hexed Gold UCLA Cylinder using the Certain QuickSeat Activator Tool (see page 11). Place the proper diameter cylinder into the implant analog.

Or

1.  Place the proper diameter Hexed Gold UCLA Cylinder or Hexed Castable UCLA Cylinder onto the implant analog, engaging the hex.

2.  Thread a Try-in Screw [MUNITS, IUNITS or UNITS] or Waxing Screw [IWSU30 or WSU30] into the implant analog and finger-tighten using a .048" Large Hex Driver [PHD02N or PHD03N]. Reduce or adjust the plastic sleeve as necessary. Add wax to the waxing sleeve to form the custom abutment with ideal emergence, angulation and crown margins.

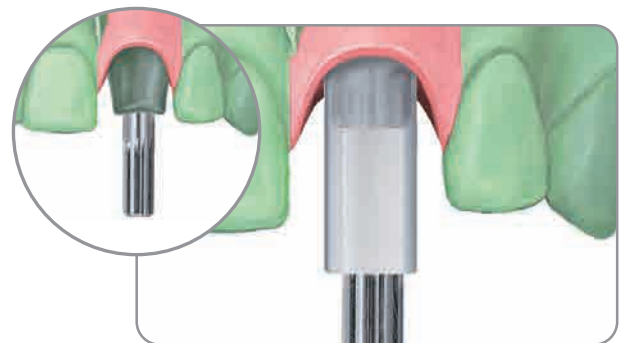

3.  Carefully remove the waxed custom abutment from the implant analog. Invest, burnout and cast the custom abutment using a low, medium or high noble alloy (see page 13 for casting alloy specifications). Chemically divest and finish the custom abutment. Polish the Hexed Gold UCLA Cylinder and entire subgingival portions of the abutment with a polishing protector in place.



4.  Place the finished custom abutment back onto the implant analog in the cast, thread a try-in screw into the implant analog and finger-tighten using the .048" Large Hex Driver [PHD02N or PHD03N]. Cover the access opening with wax. Wax the porcelain-fused-to-metal (PFM) crown coping on the custom abutment. Invest, burnout and cast the coping in a low, medium or high noble alloy. Opaque, build porcelain, stain and glaze the crown. Similar procedures can be used for all-metal implant restorations.



#### Restorative Dentist

5.  Remove the healing abutment from the implant using a .048" Large Hex Driver [PHD02N or PHD03N]. To help prevent accidental swallowing, thread floss through the spinner of the driver.



 Activate the fingers of the custom-made UCLA Abutment using the Certain QuickSeat Activator Tool (see page 11). Place the custom abutment into the implant, line up the hex and press firmly until hearing and feeling an audible and tactile click. Thread a Certain Gold-Tite Hexed Screw [UNIHG] into the implant and finger-tighten using the .048" Large Hex Driver [PHD02N or PHD03N]. To help prevent accidental swallowing, thread floss through the spinner of the driver.

Or

 Place the custom abutment onto the implant, engaging the hex. Thread a Gold-Tite Square Screw [UNISG] into the implant and finger-tighten using a Square Driver [PSQD0N or PSQD1N]. To help prevent accidental swallowing, thread floss through the spinner of the driver.

Radiograph the interface to verify an accurate fit.

**NOTE:** The abutment should be placed in the same position as it was prepared on the cast. A dimple on the facial surface guides clinicians with accurate placement.

6.  Try the crown on the custom abutment. Check the interproximal contacts, marginal fit and occlusion. Remove the crown.

 Torque the Certain screw to 20 Ncm using a .048" Large Hex Driver Tip [RASH3N or RASH8N] with a torque device [L-TIRW or HTD-C].

Or

 Torque the square screw to 32-35 Ncm using the Square Driver Tip [RASQ3N or RASQ8N] with a torque device [L-TIRW or HTD-C].

 Place protective material into the screw access opening. Seal the access opening with temporary filling material. Cement the crown to the custom abutment using temporary or permanent cement. Remove any excess cement.



## UCLA Abutment | Multiple-Unit | Indirect Technique

(See page 38 for considerations and specifications)

### Restorative Dentist

1.  Follow the steps for implant level impressions on pages 18-20 for the Pick-Up Technique and pages 21-23 for the Twist Lock Transfer Technique.



### Laboratory

2.  Deactivate the fingers of the Certain Hexed Gold UCLA Cylinders using the Certain QuickSeat Activator Tool (see page 11). Place the proper diameter cylinders into the implant analogs.

Or

 Place the proper diameter Hexed Gold or Hexed Castable UCLA Cylinders onto the implant analogs, engaging the hex.

 Thread Try-in Screws [MUNITS, ILRGHT or UNITS] or Waxing Screws [IWSU30 or WSU30] into the implant analogs and finger-tighten using a .048" Large Hex Driver [PHD02N or PHD03N]. Reduce or adjust the plastic sleeves as necessary. Add wax to the waxing sleeves to form the custom abutments with ideal emergence, angulation, parallelism and crown margins.

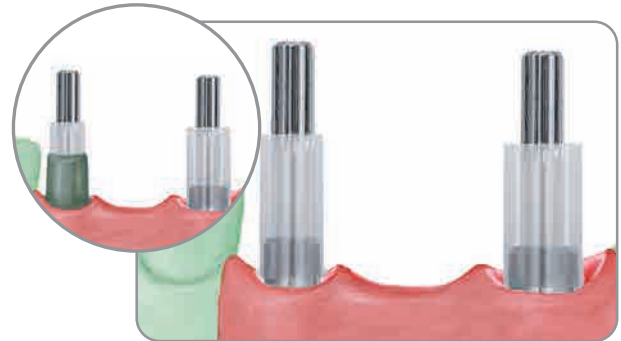

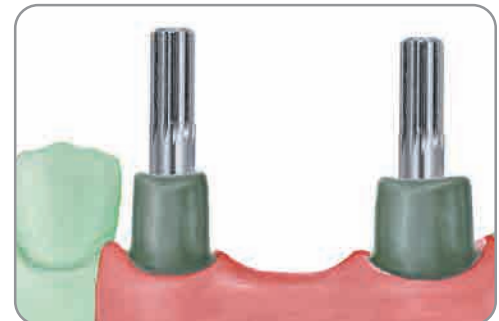

3.  Carefully remove the wax custom abutments from the implant analogs. Invest, burnout and cast the custom abutments using a low, medium or high noble alloy (see page 14 for casting alloy specifications). Chemically divest and finish the custom abutments. Polish the cylinders and entire subgingival portions of the abutments with polishing protectors in place.

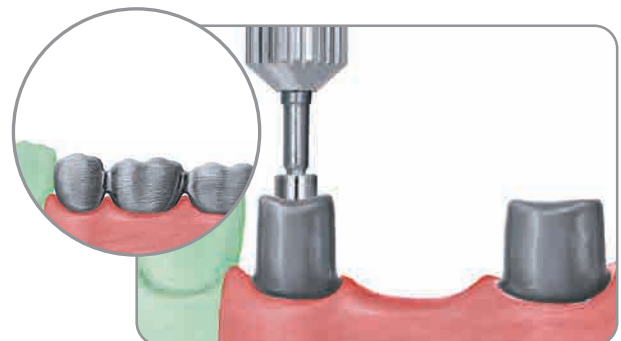

4.  Place the finished custom abutments back onto the implant analogs in the cast, thread try-in screws into the implant analogs and finger-tighten using the .048" Large Hex Driver [PHD02N or PHD03N]. Cover the access openings with wax. Wax the framework on the custom abutments. Invest, burnout and cast the framework in a low, medium or high noble alloy. Return to the restorative dentist for the metal framework try in.





**Restorative Dentist (Framework Try in)**

5.   Remove the healing abutments from the implants using a .048" Large Hex Driver [PHD02N or PHD03N]. To help prevent accidental swallowing, thread floss through the spinner of the driver.



 Activate the Certain Hexed Gold UCLA Cylinder fingers using the Certain QuickSeat Activator Tool (see page 11). Place the custom abutments into the implants, line up the hex and press firmly until hearing and feeling an audible and tactile click.

Or



 Place the custom abutments onto the implants, engaging the hex.

  Thread a try-in screw into each abutment and finger-tighten using the .048" Large Hex Driver [PHD02N or PHD03N]. To help prevent accidental swallowing, thread floss through the spinner of the driver.





6.   Radiograph the interfaces to verify an accurate fit. Place the framework on the custom abutments and verify a complete fit. A complete fit is indicated with the framework accurately fitting the margins of the abutments. Radiographs are sometimes necessary with subgingival margins. Cut and index the framework intraorally if a fit discrepancy is found. Immediately replace the healing abutments back onto the implants.

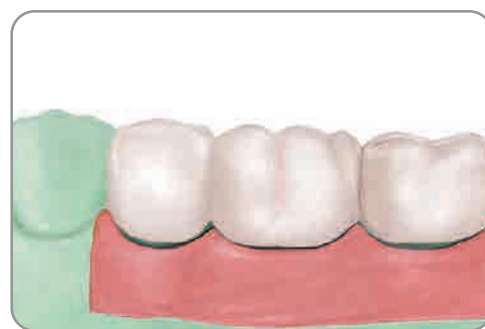

**NOTE:** The abutments should be placed in the same position as they were prepared on the cast. A dimple on the facial surface guides clinicians with accurate placement.

  Return the framework to the laboratory for soldering or welding. Another framework try in may be necessary to verify a complete fit.

**Laboratory**

7.   Place the custom abutments back onto the implant analogs in the cast and attach them using try-in screws. Opaque and build porcelain on the framework. Stain and glaze the porcelain.

**Restorative Dentist**

8.   Remove the healing abutments from the implants using a .048" Large Hex Driver [PHD02N or PHD03N]. To help prevent accidental swallowing, thread floss through the spinner of the driver.

 Activate the Hexed Gold UCLA Cylinder fingers using the Certain QuickSeat Activator Tool (see page 11). Place the custom abutments into the implants, line up the hex and press firmly until hearing and feeling an audible and tactile click. Thread a Certain Gold-Tite Hexed Screw [IUNIHG] and finger-tighten using the .048" Large Hex Driver [PHD02N or PHD03N]. To help prevent accidental swallowing, thread floss through the spinner of the driver.

Or

 Place the custom abutments onto the implants, engaging the hex. Thread Gold-Tite Square Screws [UNISG] into the implants and finger-tighten using a Square Driver [PSQD0N or PSQD1N]. To help prevent accidental swallowing, thread floss through the spinner of the driver.

  Radiograph the interface to verify an accurate fit.

**NOTE:** The abutments should be placed in the same position as they were prepared on the cast. A dimple on the facial surface guides clinicians with accurate placement.



9.  Try the prosthesis onto the custom abutments. Check the interproximal contacts, marginal fit and occlusion.

 Torque the Certain screws to 20 Ncm using a .048" Large Hex Driver Tip [RASH3N or RASH8N] with a torque device [L-TIRW or HTD-C].

Or

 Torque the square screws to 32-35 Ncm using the Square Driver Tip [RASQ3N or RASQ8N] with a torque device [L-TIRW or HTD-C].



10.  Place protective material into the screw access openings. Seal the access openings with temporary filling material and composite resin. Cement the prosthesis to the abutments using temporary or permanent cement. Remove any excess cement. Make any necessary occlusal adjustments.

**NOTE:** The prosthesis should be polished outside of the mouth prior to cementation.

# Screw-Retained Restorations

## PreFormance Temporary Cylinders

### Considerations:

- Single and multiple-unit screw-retained provisional restorations
- Minimum interarch space of 6 mm
- Maximum angulation of 15°
- Intraoral use limited to 180 days
- Immediate nonocclusal loading of single-unit provisional restorations
- Multiple-unit restorations will require an evaluation of prosthesis support to minimize the load on the provisional abutments
- Occlusal loading of single and multi-unit restorations of integrated implants for guided tissue healing

### Specifications:

- PEEK; Titanium Alloy Connection

### Instrumentation Needed:

- Waxing Screw [IWSU30 or WSU30]
- .048" Large Hex Driver [PHD02N or PHD03N]
- Hexed Titanium Screw [IUNIHT or UNIHT]
- .048" Large Hex Driver [PHD02N or PHD03N]
- .048" Large Hex Driver Tip [RASH3N or RASH8N]
- Torque Device [L-TIRW or HTD-C]



## PreFormance Temporary Cylinder | Single-Unit | Indirect Technique

### Restorative Dentist

1.   Follow the steps for implant level impressions on pages 18-20 for the Pick-Up Technique and pages 21-23 for the Twist Lock Transfer Technique.



### Laboratory

2.   Set a denture tooth in wax on the cast where the single tooth is missing.

Make a vacuum-formed template over the denture tooth and the adjacent teeth on the cast. Remove the template, denture tooth and wax from the cast.

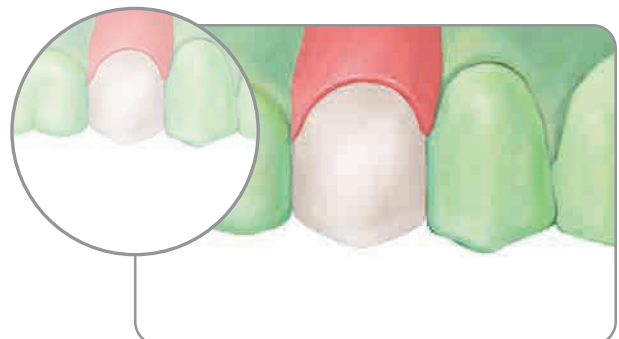





3.  Select the proper diameter Hexed PreFormance Temporary Cylinder by matching it to the implant platform color. Place it into the implant analog, line up the hex and press firmly until hearing and feeling an audible and tactile click (see page 11).

Or

 Place the proper diameter Hexed PreFormance Temporary Cylinder onto the implant analog, engaging the hex.

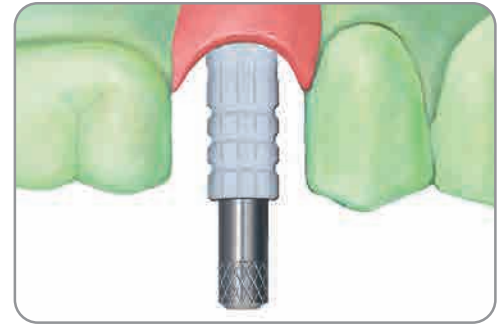
 Thread a Waxing Screw [[IWSU30](#) or [WSU30](#)] into the implant analog and finger-tighten using a .048" Large Hex Driver [[PHD02N](#) or [PHD03N](#)]. To help prevent accidental swallowing, thread floss through the spinner of the driver.



4.  Reduce or adjust the cylinder as necessary. Block out any undercuts apical to the contact points of the adjacent teeth.

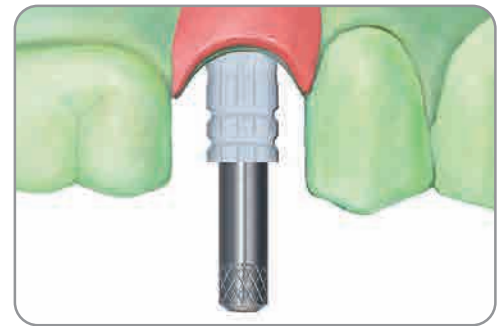

5.  Cut a hole in the template to accommodate the waxing screw [[IWSU30](#) or [WSU30](#)]. Add acrylic resin to the cylinder and template and place the template on the cast to form the provisional crown. Allow the acrylic resin to set per the manufacturer's instructions. Remove the waxing screw and template from the cast. Remove the crown from the template. Place a matching laboratory analog onto the restorative platform. Fill in any voids around the subgingival area. Contour and polish the crown. Place the crown back onto the cast and thread a Hexed Titanium Screw [[IUNIHT](#) or [UNIHT](#)] into the laboratory analog and finger-tighten using the .048" Large Hex Driver [[PHD02N](#) or [PHD03N](#)].

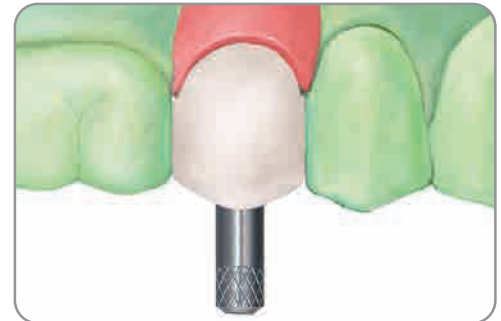

#### Restorative Dentist

6.  Remove the healing abutment from the implant using a .048" Large Hex Driver ([PHD02N](#) or [PHD03N](#)). To help prevent accidental swallowing, thread floss through the spinner of the driver.

 Activate the PreFormance Temporary Cylinder fingers using the Certain QuickSeat Activator Tool (see page 11). Place the provisional crown into the implant, line up the hex and press firmly until hearing and feeling an audible and tactile click.

Or

 Place the provisional crown onto the implant, engaging the hex.

 Thread a Hexed Titanium Screw [[IUNIHT](#) or [UNIHT](#)] into the implant and finger-tighten using the .048" Large Hex Driver [[PHD02N](#) or [PHD03N](#)]. To help prevent accidental swallowing, thread floss through the spinner of the driver. Check the interproximal contacts. Torque the screw to 20 Ncm using a .048" Large Hex Driver Tip [[RASH3N](#) or [RASH8N](#)] with a torque device [[L-TIRW](#) or [HTD-C](#)]. Place protective material into the screw access opening. Seal the access opening with temporary filling material and composite resin. Make any necessary occlusal adjustments.





## PreFormance Temporary Cylinder | Single-Unit | Direct Technique

(See page 43 for considerations and specifications)

### Laboratory

1.  Set a denture tooth in wax on the cast where the single tooth is missing. Make a vacuum-formed template over the denture tooth and adjacent teeth on the cast. Remove the template, denture tooth and wax from the cast.

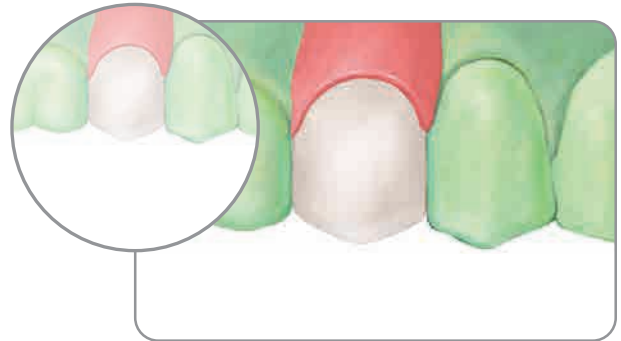

### Restorative Dentist

2.  Select the proper diameter Hexed PreFormance Temporary Cylinder by matching it to the implant platform color. Place it into the implant, line up the hex and press firmly until hearing and feeling an audible and tactile click (see page 11).

Or

 Place the Hexed PreFormance Temporary Cylinder onto the implant analog, engaging the hex.

 Thread a Waxing Screw [[IWSU30](#) or [WSU30](#)] into the implant analog and finger-tighten using a .048" Large Hex Driver [[PHD02N](#) or [PHD03N](#)]. To help prevent accidental swallowing, thread floss through the spinner of the driver. Mark the cylinder with a pencil to areas requiring preparation.

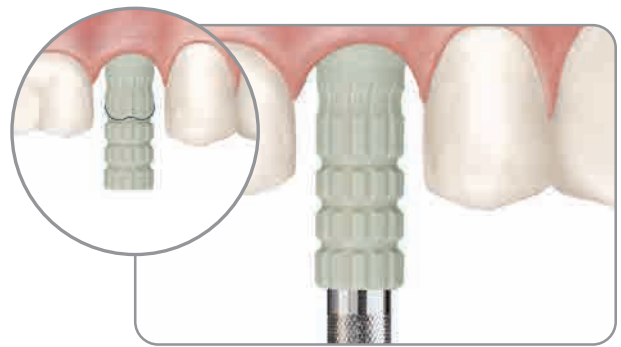

3.  Prepare the cylinder intraorally or remove it and place it on a Laboratory Abutment Holder [[ILTAH57](#), [LTAH5](#), [LTAH7](#)]. Reduce the cylinder with a high speed handpiece, a coarse diamond bur with irrigation.



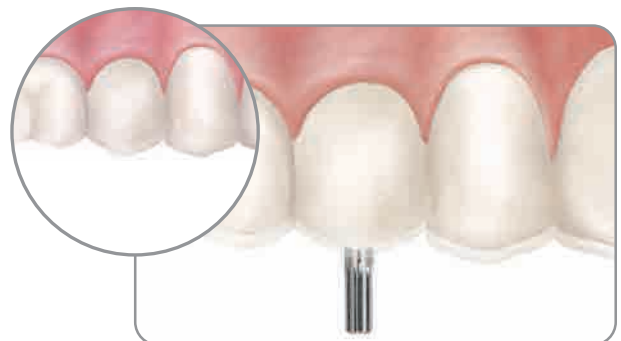

4.  Cut a hole in the template to accommodate the waxing screw. Add acrylic resin to the cylinder and template and place the template over the cylinder. Allow the acrylic resin to set per the manufacturer's instructions. Remove the waxing screw and template from the patient. Remove the crown from the template. Fill any voids around the subgingival area. Contour and polish the crown. Place the crown back onto the implant and thread a Hexed Titanium Screw [[IUNIHT](#) or [UNIHT](#)] torqued to 20 Ncm using the .048" Large Hex Driver Tip [[RASH3N](#) or [RASH8N](#)] with a torque device [[L-TIRW](#) or [HTD-C](#)]. Place a protective material over the screw head and seal the access hole with composite resin. Make any necessary occlusal adjustments.



## PreFormance Temporary Cylinder | Multiple-Unit | Indirect Technique



(See page 43 for considerations and specifications)

### Restorative Dentist

1.   Follow the steps for implant level impressions on pages 18-20 for the Pick-Up Technique and pages 21-23 for the Twist Lock Transfer Technique.



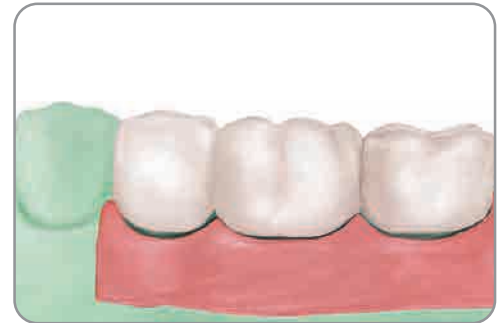

### Laboratory

2.   Set the denture teeth in wax on the cast where the teeth are missing.





3.   Make a vacuum-formed template over the denture teeth and adjacent teeth. Remove the template, denture teeth and wax from the cast.



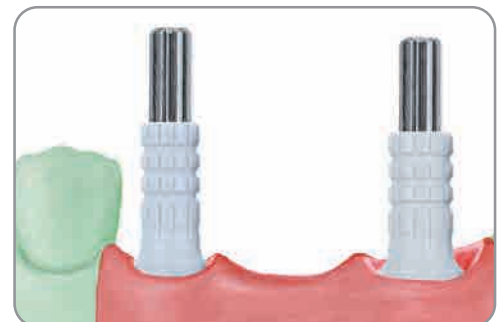

4.   Select and place the proper diameter Non-Hexed PreFormance Temporary Cylinders onto the implant analogs.

Thread Waxing Screws [[IWSU30](#) or [WSU30](#)] into the implant analogs and finger-tighten using a .048" Large Hex Driver [[PHD02N](#) or [PHD03N](#)].

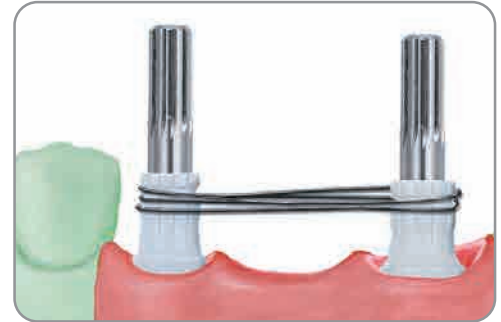

5.  Reduce or adjust the cylinders as necessary. The cylinders may be connected with orthodontic wire or a framework may be waxed and cast to support a pontic. Block out any undercuts apical to the contact points of the adjacent teeth.



6.  Cut holes in the template for the waxing screws to come through. Add acrylic resin to the cylinders and inside the template to form the provisional prosthesis. Place the template on the cast.

Allow the acrylic resin to set per the manufacturer's instructions. Remove the waxing screws and the template from the cast.

Remove the provisional prosthesis from the template. Place matching laboratory analogs onto the restorative platforms. Fill in any voids around the subgingival areas. Contour and polish the prosthesis. Place the prosthesis back on the cast. Thread Hexed Titanium Screws [JUNIHT or UNIHT] into the laboratory analogs and finger-tighten using a .048" Large Hex Driver [PHD02N or PHD03N]. Make any necessary occlusal adjustments.



#### Restorative Dentist

7.  Remove the healing abutments from the implants using a .048" Large Hex Driver [PHD02N or PHD03N]. To help prevent accidental swallowing, thread floss through the spinner of the driver. Place the provisional restoration onto the implants. Thread Hexed Titanium Screws [JUNIHT or UNIHT] into the implants and finger-tighten using the .048" Large Hex Driver.

Check the interproximal and occlusal contacts. Torque the screws to 20 Ncm using a .048" Large Hex Driver Tip [RASH3N or RASH8N] with a torque device [L-TIRW or HTD-C]. Place protective material into the screw access opening. Seal the access openings with temporary filling material and composite resin. Make any necessary occlusal adjustments.



## Titanium Temporary Cylinders

### Considerations:

- Single and multiple-unit screw-retained provisional restorations
- Minimum interarch space of 6 mm
- Maximum angulation of 15°
- Immediate nonocclusal loading of single-unit provisional restorations
- Multiple-unit restorations will require an evaluation of prosthesis support to minimize the load on the provisional abutments
- Occlusal loading of single and multi-unit restorations of integrated implants for guided tissue healing

### Specifications:



- Titanium Alloy Connection

### Instrumentation Needed:

- Waxing Screw [IWSU30 or WSU30]
- .048" Large Hex Driver [PHD02N or PHD03N]
- Hexed Titanium Screw [IUNIHT or UNIHT]
- .048" Large Hex Driver Tip [RASH3N or RASH8N]
- Torque Device [L-TIRW or HTD-C]

## Titanium Temporary Cylinder | Single-Unit | Indirect Technique

### Restorative Dentist



1.   Follow the steps for implant level impressions on pages 18-20 for the Pick-Up Technique and pages 21-23 for the Twist Lock Transfer Technique.

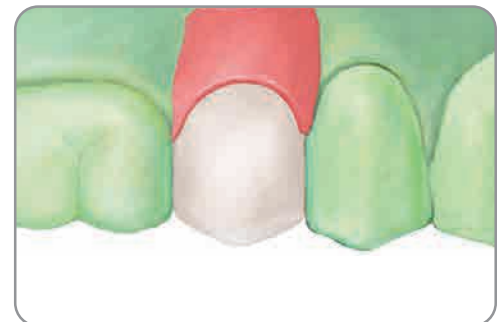

### Laboratory

2.   Set a denture tooth in wax on the cast where the single tooth is missing.





3.   Make a vacuum-formed template over the denture tooth and adjacent teeth on the cast. Remove the template, denture tooth and wax from the cast.





4.  Select the proper diameter Hexed Titanium Temporary Cylinder by matching it to the implant platform color. Place it into the implant analog, line up the hex and press firmly until hearing and feeling an audible and tactile click (see page 11).

Or

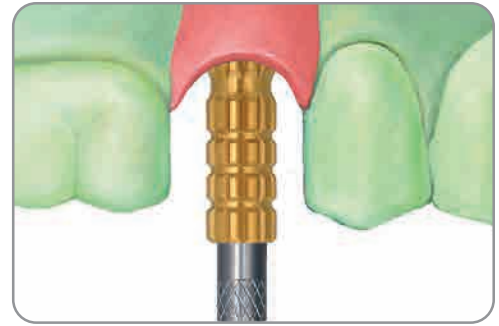

 Place the proper diameter Hexed Titanium Temporary Cylinder onto the implant analog, engaging the hex.

 Thread a Waxing Screw [[IWSU30](#) or [WSU30](#)] into the implant analog and finger-tighten using a .048" Large Hex Driver [[PHD02N](#) or [PHD03N](#)]. To help prevent accidental swallowing, thread floss through the spinner of the driver.

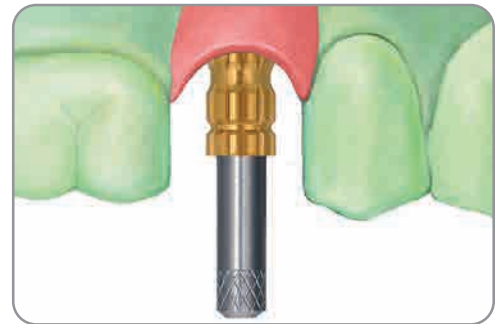

5.   Reduce or adjust the cylinder as necessary. Block out any undercuts apical to the contact points of the adjacent teeth.



6.   Cut a hole in the template to accommodate the waxing screw. Add acrylic resin to the cylinder and template and place the template on the cast to form the provisional crown. Allow the acrylic resin to set per the manufacturer's instructions. Remove the waxing screw and template from the cast. Remove the crown from the template. Place a matching laboratory analog onto the restorative platform. Fill any voids around the subgingival area. Contour and polish the crown. Place the crown back onto the cast, thread a Hexed Titanium Screw [[IUNIHT](#) or [UNIHT](#)] into the analog and finger-tighten using a .048" Large Hex Driver [[PHD02N](#) or [PHD03N](#)]. Make any necessary occlusal adjustments.

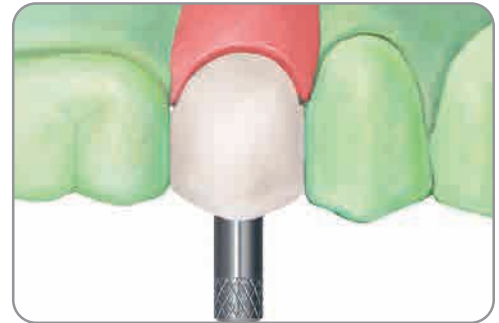

#### Restorative Dentist

7.  Remove the healing abutment from the implant using a .048" Large Hex Driver [[PHD02N](#) or [PHD03N](#)]. To help prevent accidental swallowing, thread floss through the spinner of the driver.

 Activate the Titanium Temporary Cylinder fingers using the Certain QuickSeat Activator Tool (see page 11). Place the provisional crown into the implant, line up the hex and press firmly until hearing and feeling an audible and tactile click.

Or

 Place the provisional crown onto the implant, engaging the hex.



 Thread a Hexed Titanium Screw [[IUNIHT](#) or [UNIHT](#)] into the implant and finger-tighten using the .048" Large Hex Driver [[PHD02N](#) or [PHD03N](#)]. To help prevent accidental swallowing, thread floss through the spinner of the driver. Radiograph the interface to verify an accurate fit. Check the interproximal and occlusal contacts. Torque the screw to 20 Ncm using a .048" Large Hex Driver Tip [[RASH3N](#) or [RASH8N](#)] with a torque device [[L-TIRW](#) or [HTD-C](#)]. Place protective material into the screw access opening. Seal the access opening with temporary filling material and composite resin. Make any necessary occlusal adjustments.



## Titanium Temporary Cylinder | Multiple-Unit | Indirect Technique



(See page 48 for considerations and specifications)

### Restorative Dentist



1.   Follow the steps for implant level impressions on pages 18-20 for the Pick-Up Technique and pages 21-23 for the Twist Lock Transfer Technique.



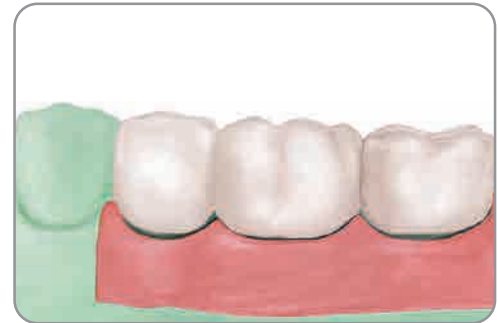

### Laboratory

2.   Set the denture teeth in wax on the cast where the teeth are missing.



3.   Make a vacuum-formed template over the denture teeth and adjacent teeth. Remove the template, denture teeth and wax from the cast.



4.   Select and place the proper diameter Non-Hexed Titanium Temporary Cylinders onto the implant analogs. Thread Waxing Screws [IWSU30 or WSU30] into the implant analogs and finger-tighten using a .048" Large Hex Driver [PHD02N or PHD03N].

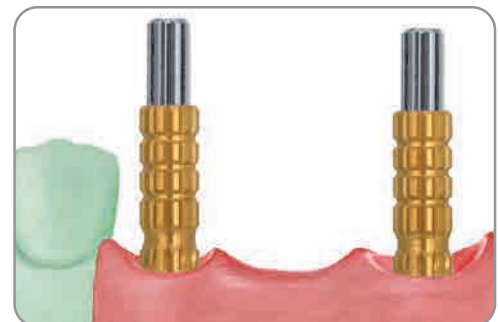

5.  Reduce or adjust the cylinders as necessary. The cylinders may be connected with orthodontic wire or a framework may be waxed and cast to support a pontic. Block out any undercuts apical to the contact points of the adjacent teeth.

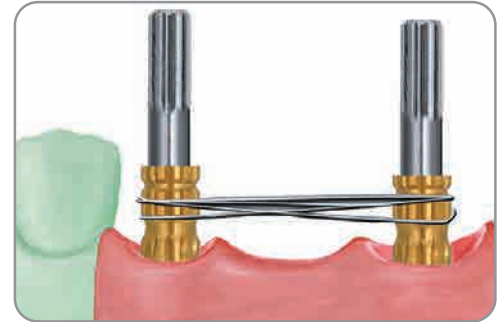

6.  Cut holes in the template for the waxing screws to come through. Add acrylic resin to the cylinders and inside the template to form the provisional prosthesis. Place the template on the cast. Allow the acrylic resin to set per the manufacturer's instructions. Remove the waxing screws and template from the cast. Remove the provisional prosthesis from the template. Place matching laboratory analogs onto the restorative platforms. Fill in any voids around the subgingival areas. Contour and polish the prosthesis. Place the prosthesis back on the cast, thread Hexed Titanium Screws [[IUNIHT or UNIHT](#)] into the laboratory analogs and finger-tighten using a .048" Large Hex Driver [[PHD02N or PHD03N](#)]. Make any necessary occlusal adjustments.

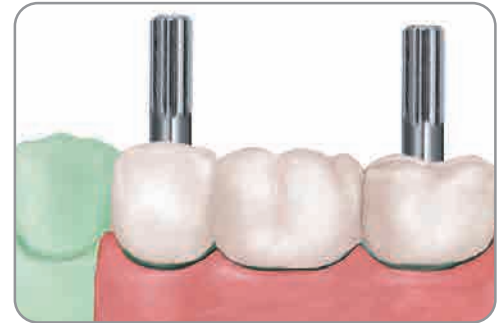

#### Restorative Dentist

7.  Remove the healing abutments from the implants using a .048" Large Hex Driver [[PHD02N or PHD03N](#)]. To help prevent accidental swallowing, thread floss through the spinner of the driver. Place the provisional restoration onto the implants. Thread Hexed Titanium Screws [[IUNIHT or UNIHT](#)] into the implants and finger-tighten using the .048" Large Hex Driver [[PHD02N or PHD03N](#)]. To help prevent accidental swallowing, thread floss through the spinner of the driver.



Radiograph the interface to verify an accurate fit. Check the interproximal and occlusal contacts. Torque the screws to 20 Ncm using a .048" Large Hex Driver Tip [[RASH3N or RASH8N](#)] with a torque device [[L-TIRW or HTD-C](#)]. Place protective material into the screw access openings. Seal the access openings with temporary filling material and composite resin. Make any necessary occlusal adjustments.



## BellaTek Express and Flex Abutments

### Considerations:

- The BellaTek Express and Flex Abutments and the Angled Screw Channel Drivers and Tips are provided non-sterile.
- The Angled Screw Channel Drivers and Tips are reusable up to 15 uses and require cleaning and sterilization prior to each use. For recommended cleaning and sterilization procedures of the Angled Screw Channel Driver, please refer to Cleaning and Sterilization of Biomet 3i Kits and Instruments [P-ZBDINSTRP] available at <http://ifu.biomet3i.com> to look up the specific part number.
- The Angled Screw Channel Drivers and Tips should be inspected for wear before each use.

### Specifications:

- Titanium with Nitride Coating

### Instrumentation Needed:

#### For Certain Implants:

- The Angled Screw Channel Driver Tips [ASCDT24 and ASCDT30] are designed to be used with 0.048" hexed Gold-Tite Screws [IUNIHG and ILRGHG] only.

## Introduction

This Restorative Clinician Manual was created for dentists placing final restorations with BellaTek Express and Flex Abutments with the Angled Screw Channel Driver Tip for screw-retained restorations.

## Device Description

BellaTek Express and BellaTek Flex are the original cement- or screw-retained abutments with an angled screw access channel for Zimmer Biomet Dental Certain® Implants. Add efficiency to your CAD/CAM single- or multi-unit implant restorations with the flexibility of adjusting the abutment at four different heights, and strength with thicker abutment walls on wider implant platform diameters.

The Angled Screw Channel Driver Tips solve the problem of screw-retained restorations in the anterior by moving the screw channel from buccal to lingual and makes it easier to access the challenging occlusal inter-arch space in the posterior by engaging the screw at an angle.

## BellaTek Express and Flex Abutments

### Remove the Healing Abutment

1. Remove the healing abutment from the implant. To help prevent accidental swallowing, thread floss through the spinner of the driver.

Use a .048" Large Hex Driver [PHD02N or PHD03N].

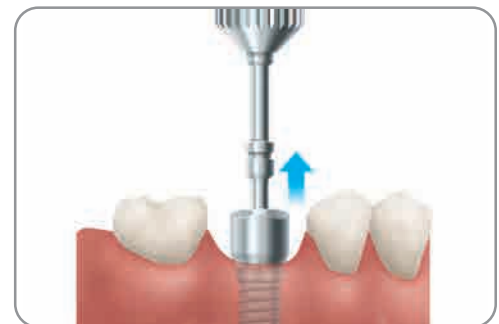



### Place the Restoration

#### 2a. Place the restoration onto the implant.

For single-unit restorations, line up the hex and press firmly onto the implant until hearing an audible and tactile click. Thread a Certain Gold-Tite Hexed Screw [IUNIHG for single-unit or ILRGHG for multi-unit] into the implant and finger tighten using a .048" Large Hex Driver [PHD02N or PHD03N] or an Angled Screw Channel Driver Tip [ASCDT24 or ASCDT30] connected to the L-TIRW Standard ISO 1797 Adapter [C9980].

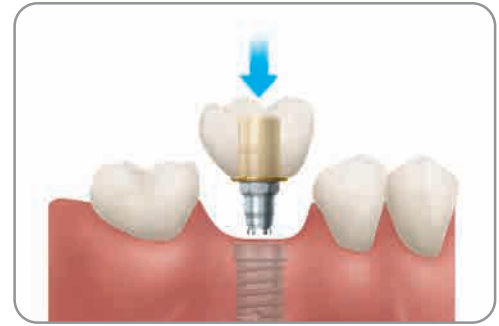

#### 2b. Take a radiograph of the interface to verify if the abutment is fully seated. Adjust the occlusion, marginal fit and interproximal contacts as necessary.

### Torque the Restoration

#### 3a. Torque the Certain Gold-Tite Screw to 20 Ncm using a .048" Large Hex Driver Tip [RASH3N or RASH8N] or an Angled Screw Channel Driver Tip [ASCDT24 or ASCDT30] with a torque device [L-TIRW or HTD-C].

#### 3b. Seal the access opening with temporary filling material and composite resin. Make any necessary occlusal adjustments.



## UCLA Abutments

### Considerations:

- Single and multiple-unit screw-retained restorations
- Minimum interarch space of 4 mm
- For aesthetic restorations when tissue is limited

### Specifications:

- Machined Gold Alloy Cylinder With Plastic Unitube

### Instrumentation Needed:

- Screw [MUNITS, IUNITS or UNITS]
- Waxing Screw [IWSU30 or WSU30]
- .048" Large Hex Driver [PHD02N or PHD03N]
- Certain Gold-Tite Hexed Screw [IUNIHG]
- Certain Gold-Tite Large Hexed Screws [ILRGHG]
- Gold-Tite Square Screw [UNISG]
- Square Driver [PSQD0N or PSQD1N]
- .048" Large Hex Driver Tip [RASH3N or RASH8N]
- Torque Device [L-TIRW or HTD-C]
- Square Driver Tip [RASQ3N or RASQ8N]

## UCLA Abutment | Single-Unit | Indirect Technique

### Restorative Dentist

1.  Follow the steps for implant level impressions on pages 18-20 for the Pick-Up Technique and pages 21-23 for the Twist Lock Transfer Technique.



### Laboratory

2.  Deactivate the fingers of the Certain Hexed Gold UCLA Cylinder using the Certain QuickSeat Activator Tool (see page 11). Place the proper diameter cylinder into the implant analog.

Or

2.  Place the proper diameter Hexed Gold UCLA Cylinder or Hexed Castable UCLA Cylinder onto the implant analog, engaging the hex.

3.  Thread a Try-in Screw [MUNITS, IUNITS or UNITS] or Waxing Screw [IWSU30 or WSU30] into the implant analog and finger-tighten using a .048" Large Hex Driver [PHD02N or PHD03N]. Reduce or adjust the plastic sleeve as necessary. Add wax to the waxing sleeve to form the custom metal framework contours.

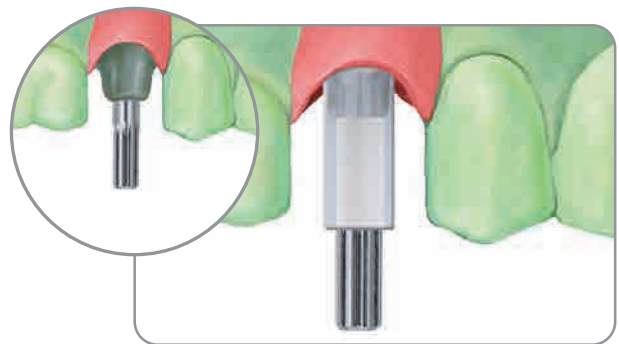

3.  Remove the try-in or waxing screw and carefully remove the waxed framework from the analog. Invest, burnout and cast the framework using a low, medium or high noble alloy (see page 13 for casting alloy specifications). Chemically divest and finish the metal framework.

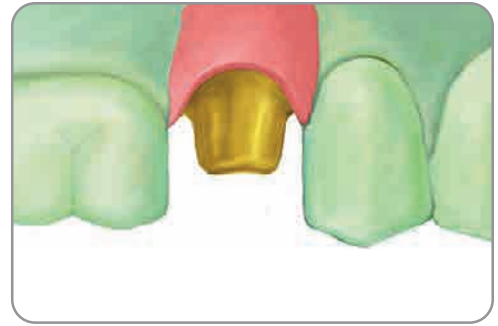

4.  Place the metal framework back onto the analog in the cast, and thread a try-in or waxing screw into the analog and finger-tighten. Opaque and build porcelain on the metal framework. Stain and glaze the porcelain. Polish the Gold UCLA Cylinder with a polishing protector in place.

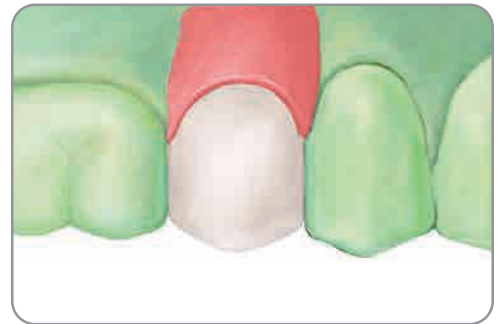



#### Restorative Dentist

5.  Remove the healing abutment from the implant using a .048" Large Hex Driver [[PHD02N](#) or [PHD03N](#)]. To help prevent accidental swallowing, thread floss through the spinner of the driver.

 Activate the UCLA Abutment fingers using the Certain QuickSeat Activator Tool (see page 11). Place the crown into the implant, line up the hex and press firmly until hearing and feeling an audible and tactile click. Thread a Certain Gold-Tite Hexed Screw [[IUNIHG](#)] into the implant and finger-tighten using a .048" Large Hex Driver [[PHD02N](#) or [PHD03N](#)].

Or

 Place the crown onto the implant, engaging the hex. Thread a Gold-Tite Square Screw [[UNISG](#)] into the implant and finger-tighten using a Square Driver [[PSQD0N](#) or [PSQD1N](#)]. To help prevent accidental swallowing, thread floss through the spinner of the driver.

 Radiograph the interface to verify an accurate fit. Adjust the occlusion, marginal fit and interproximal contacts as necessary.

6.  Torque the Certain screw to 20 Ncm using a .048" Large Hex Driver Tip [[RASH3N](#) or [RASH8N](#)] with a torque device [[L-TIRW](#) or [HTD-C](#)].

Or

 Torque the square screw to 32-35 Ncm using a Square Driver Tip [[RASQ3N](#) or [RASQ8N](#)] with a torque device [[L-TIRW](#) or [HTD-C](#)].





7.  Place protective material into the screw access opening. Seal the access opening with temporary filling material and composite resin. Make any necessary occlusal adjustments.

## UCLA Abutment | Multiple-Unit | Indirect Technique



(See page 54 for considerations and specifications)

### Restorative Dentist

1.   Follow the steps for implant level impressions on pages 18-20 for the Pick-Up Technique and pages 21-23 for the Twist Lock Transfer Technique.



### Laboratory

2.   Place the proper diameter Non-Hexed Gold UCLA Cylinder or Non-Hexed Castable UCLA Cylinder into the implant analogs.



 Thread Certain Large Titanium Hexed Screws [ILRGHT] or Waxing Screw [IWSU30] into the implant analogs and finger-tighten using the .048" Large Hex Driver [PHD02N or PHD03N].

Or

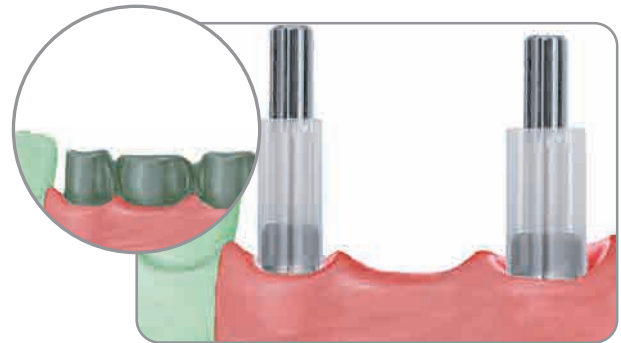
 Thread Try-in Screws [MUNITS or UNITS] or Waxing Screws [WSU30] into the implant analogs and finger-tighten using a .048" Large Hex Driver [PHD02N or PHD03N].



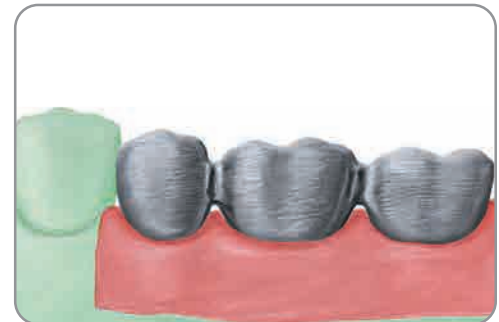

Reduce or adjust the plastic sleeves as necessary. Wax the framework to the waxing sleeves.

3.   Remove the try-in or waxing screws and then carefully remove the wax framework from the implant analogs. Invest, burnout and cast the porcelain-fused-to-metal (PFM) framework using a low, medium or high noble alloy (see page 14 for casting alloy specifications). Chemically divest and finish the framework. Return to the restorative dentist for the metal framework try in.





### Restorative Dentist - One Screw Test



4.   Remove the healing abutments from the implants using a .048" Large Hex Driver [PHD02N or PHD03N]. To help prevent accidental swallowing, thread floss through the spinner of the driver. Place the framework onto the implants. Place a try-in screw into the anterior-most abutment and finger-tighten using the .048" Large Hex Driver. Radiograph the interfaces of the implants/abutments. The framework fits completely if no space is visible between the seating surface of the frameworks and implants. Remove the anterior screw and repeat this procedure on the posterior implant. Take a new radiograph and evaluate it for implant/framework fit. If there is a misfit, section the framework into individual pieces (extraorally), place all of the segments back onto the implants with try-in screws and index/splint the individual segments together with autopolymerizing resin or plaster. Return the framework to the laboratory for soldering or welding. Repeat the metal framework try in to make sure that an accurate and complete fit has been obtained post soldering/welding. Immediately replace the healing abutments back onto the implants.

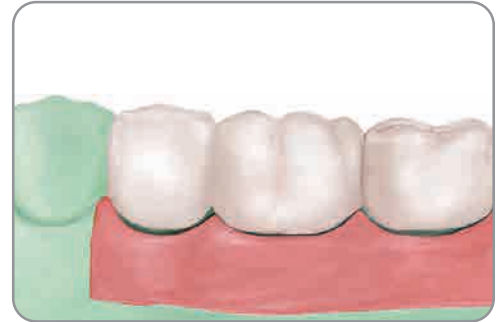

**Laboratory**

5.   Place the verified metal framework back onto the implant analogs in the cast and thread try-in or waxing screws into the implant analogs and finger-tighten. Opaque and build porcelain on the framework. Stain and glaze the porcelain. Polish the Gold UCLA Cylinders with polishing protectors in place.

**Restorative Dentist**



6.   Remove the healing abutments from the implants using a .048" Large Hex Driver [[PHD02N](#) or [PHD03N](#)]. To help prevent accidental swallowing, thread floss through the spinner of the driver. Place the prosthesis onto the implants.



-  Thread Certain Gold-Tite Large Hexed Screws [[ILRGHG](#)] into the implants and finger-tighten using the .048" Large Hex Driver [[PHD02N](#) or [PHD03N](#)]. To help prevent accidental swallowing, thread floss through the spinner of the driver.

Or



-  Thread Gold-Tite Square Screws [[UNISG](#)] into the implants and finger-tighten using a Square Driver [[PSQD0N](#) or [PSQD1N](#)]. To help prevent accidental swallowing, thread floss through the spinner of the driver.

-   Radiograph the interface of the prosthesis on the implants to verify an accurate fit. Adjust the interproximal occlusal contacts as necessary. Polish and insert the definitive prosthesis.

7.  Torque the Certain screws to 20 Ncm using a .048" Large Hex Driver Tip [[RASH3N](#) or [RASH8N](#)] with a torque device [[L-TIRW](#) or [HTD-C](#)].

Or

-  Torque the square screws to 32-35 Ncm using the Square Driver Tip [[RASQ3N](#) or [RASQ8N](#)] with a torque device [[L-TIRW](#) or [HTD-C](#)].

8.   Place protective material into the screw access openings. Seal the access openings with composite resin. Make any necessary occlusal adjustments.

## Low Profile Abutments

### Considerations:

- Single and multiple-unit screw-retained restorations
- Minimum interarch space of 7.5 mm
- Minimum tissue height of 1 mm
- Angle correction up to 30°
- External hex 3.4 mm(D) Low Profile Abutments are limited for use in the anterior

### Specifications:



- Titanium Alloy

### Instrumentation Needed:



- .048" Large Hex Driver [PHD02N or PHD03N]
- Abutment Driver Tip [RASA3]
- Torque Device [L-TIRW or HTD-C]
- Low Profile Abutment Healing Cap [LPCHC]
- .048" Large Hex Driver [PHD02N or PHD03N]
- Low Profile Titanium Retaining Screw [LPCTSH]
- Low Profile Waxing Screw [LPCWS]

## Low Profile Abutment | Single-Unit | Indirect Technique

### Surgeon or Restorative Dentist



1.  Select the proper Low Profile Abutment by matching it to the Emergence Profile (EP) and the restorative platform of the healing abutment and the implant platform diameter. Select the abutment collar height and angle (0°, 17° or 30°) by measuring the height of the healing abutment above the tissue on the buccal surface, not including the domed portion. Subtract this measurement from the total height of the healing abutment and then subtract an additional 2 mm. See pages 15-16 for the Abutment Selection Guide.
2.  Remove the healing abutment from the implant using a .048" Large Hex Driver [PHD02N or PHD03N]. To help prevent accidental swallowing, thread floss through the spinner of the driver.



3.   Activate the abutment fingers using the Certain QuickSeat Activator Tool (see page 11). Place the abutment into the implant, line up the hex and press firmly until hearing and feeling an audible and tactile click.



Or

-  Place the abutment onto the implant, engaging the hex.



-   Thread a Low Profile Abutment Screw into the implant by turning the spindle of the ASYST Tool and finger-tighten. Remove the ASYST Tool.



If correcting an angle using the Low Profile 17° or 30° Angled Abutment, place the abutment in or on the implant hex to correct angulation while holding onto the delivery tool. Insert the driver tip into the screw and finger-tighten into the implant.

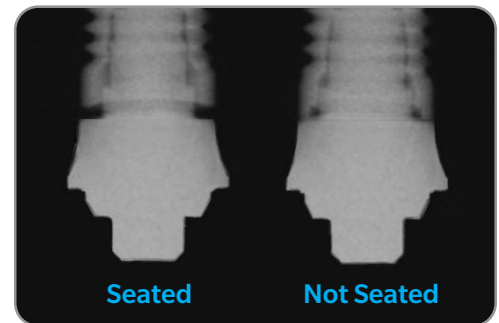

4.   Radiograph the interface to verify complete seating of the abutment on the implant. Place the film perpendicular to the interface of the abutment on the implant.





5.   **Straight Abutments:** Torque the abutment screw to 20 Ncm using an Abutment Driver Tip [RASA3] with a torque device [L-TIRW or HTD-C].

-   **Angled Abutments:** Torque the abutment screw to 20 Ncm using a .048" Large Hex Driver Tip [RASH3N or RASH8N] with a torque device [L-TIRW or HTD-C].

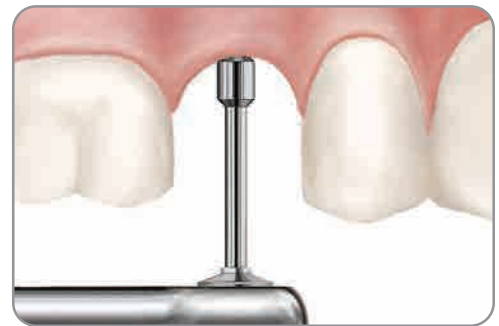
If the surgeon places the abutment, a Low Profile Abutment Healing Cap [LPCHC] is threaded onto the abutment and torque to 10 Ncm using the .048" Large Hex Driver [PHD02N or PHD03N] with a torque device [L-TIRW or HTD-C]. To help prevent accidental swallowing, thread floss through the spinner of the driver.



#### Restorative Dentist

6.   Follow the steps for abutment level impressions on pages 18-20 for the Pick-Up Technique and pages 21-23 for the Twist Lock Transfer Technique.

**NOTE:** Low Profile Abutment Impression Copings do not require activation, as there are no fingers on the copings.





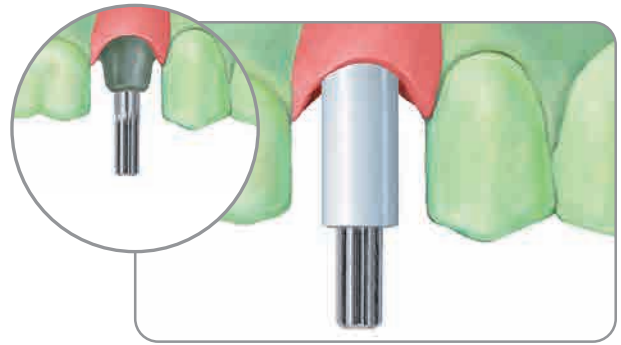

## Laboratory

7.  Place a Low Profile Abutment Hexed Gold Cylinder or Hexed Castable Cylinder onto the Low Profile Abutment Analog. Thread a Low Profile Titanium Retaining Screw [LPCTSH] or Low Profile Waxing Screw [LPCWS] into the implant analog and finger-tighten using a .048" Large Hex Driver [PHD02N or PHD03N]. Reduce or adjust the plastic sleeve as necessary. Wax the porcelain-fused-to-metal framework (PFM) to the waxing sleeve.

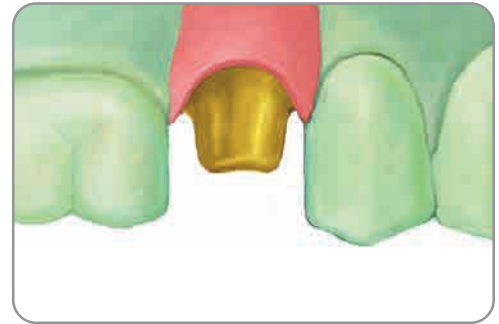

8.  Remove the retaining or waxing screw and then carefully remove the wax framework from the analog. Invest, burnout and cast the framework using a low, medium or high noble alloy (see page 14 for casting alloy specifications). Chemically divest and finish the restoration.



9.  Place the metal framework back onto the analog in the cast, and thread a Low Profile Titanium Retaining Screw [LPCTSH] or Low Profile Waxing Screw [LPCWS] into the analog and finger-tighten using a .048" Large Hex Driver [PHD02N or PHD03N]. Opaque and build porcelain on the metal framework. Stain and glaze the porcelain. Polish the Gold UCLA Cylinder with a polishing protector in place.

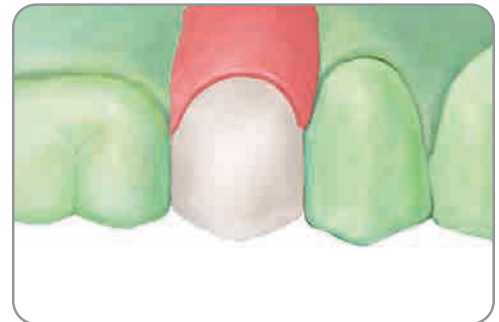

## Restorative Dentist

10.  Remove the healing cap from the abutment using a .048" Large Hex Driver [PHD02N or PHD03N]. To help prevent accidental swallowing, thread floss through the spinner of the driver. Place the crown on the abutment, engaging the hex. Thread a Low Profile Gold-Tite Retaining Screw [LPCGSH] into the abutment and finger-tighten using the .048" Large Hex Driver. Radiograph the interface to verify an accurate fit. Check the interproximal and occlusal contacts. Torque the screw to 10 Ncm using a .048" Large Hex Driver Tip [RASH3N or RASH8N] with a torque device [L-TIRW or HTD-C].



11.  Place protective material into the screw access opening. Seal the access opening with temporary filling material and composite resin. Make any necessary occlusal adjustments.







## Low Profile Abutment | Multiple-Unit | Indirect Technique

(See page 58 for considerations and specifications)

### Surgeon or Restorative Dentist

1.  Select the proper Low Profile Abutment by matching it to the Emergence Profile (EP) and the restorative platform of the healing abutment and the implant platform diameter. Select the abutment collar height and angle (0°, 17° or 30°) by measuring the height of the healing abutment above the tissue on the buccal surface, not including the domed portion. Subtract this measurement from the total height of the healing abutment and then subtract an additional 2 mm. See pages 15-16 for the Abutment Selection Guide.



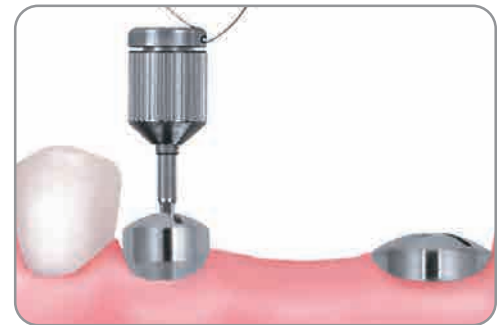

2.  Remove the healing abutment from the implant using a .048" Large Hex Driver [PHD02N or PHD03N]. To help prevent accidental swallowing, thread floss through the spinner of the driver.



3.  Activate the abutment fingers using the Certain QuickSeat Activator Tool (see page 11). Place the abutment into the implant, line up the hex and press firmly until hearing and feeling an audible and tactile click.

Or

-  Place the abutment onto the implant, engaging the hex.

-  Thread an abutment screw into the implant by turning the spindle on the ASYST Tool and finger-tighten. Remove the ASYST Tool.

If correcting an angle using the Low Profile 17° or 30° Angled Abutment, place the abutment in or on the implant hex to correct angulation while holding onto the delivery tool. Insert the driver tip into the abutment screw and finger-tighten into the implant.



4.  Radiograph the interface to verify complete seating of the abutment on the implant. Place the film perpendicular to the interface of the abutment on the implant.

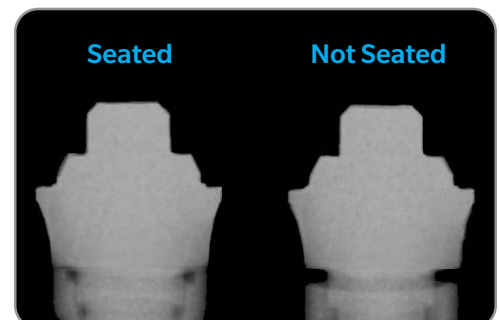

5.  **Straight Abutments:** Torque the abutment screws to 20 Ncm using an Abutment Driver Tip [[RASA3](#)] with a torque device [[L-TIRW](#) or [HTD-C](#)].

Or

 **Angled Abutments:** Torque the abutment screws to 20 Ncm using a .048" Large Hex Driver Tip [[RASH3N](#) or [RASH8N](#)] with a torque device [[L-TIRW](#) or [HTD-C](#)]. If the surgeon places the abutments, a Low Profile Abutment Healing Cap [[LPCHC](#)] is threaded onto the abutments and torque to 10 Ncm using the .048" Large Hex Driver [[PHD02N](#) or [PHD03N](#)] with a torque device [[L-TIRW](#) or [HTD-C](#)]. To help prevent accidental swallowing, thread floss through the spinner of the driver.

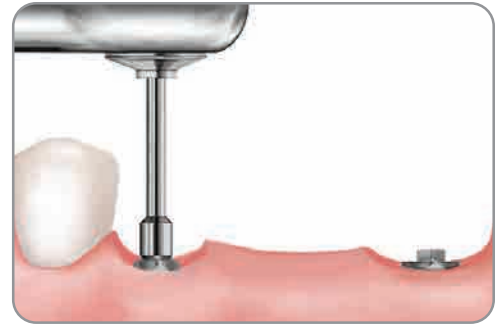

#### Restorative Dentist

6.  Follow the steps for abutment level impressions on pages 18-20 for the Pick-Up Technique and pages 21-23 for the Twist Lock Transfer Technique.

**NOTE:** Low Profile Abutment Impression Copings do not require activation, as there are no fingers on the copings.



#### Laboratory

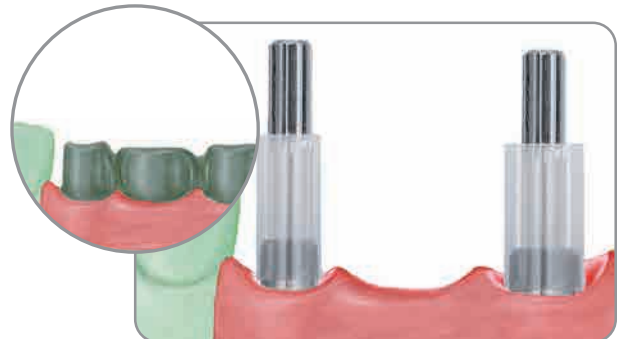

7.  Place a Non-Hexed Low Profile Gold Cylinder or Non-Hexed Castable Cylinder onto the Low Profile Analogs. Thread Low Profile Titanium Retaining Screws [[LPCTSH](#)] or Low Profile Waxing Screws [[LPCWS](#)] into the implant analogs and finger-tighten using a .048" Large Hex Driver [[PHD02N](#) or [PHD03N](#)]. Reduce or adjust the plastic sleeves as necessary. Wax the porcelain-fused-to-metal (PFM) framework to the waxing sleeves.

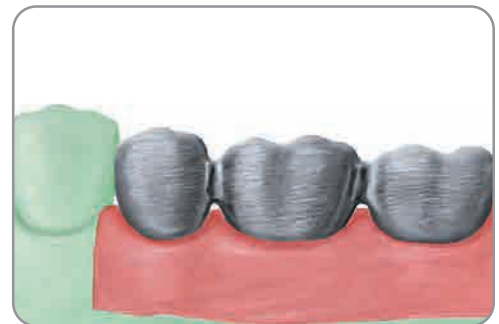

8.  Remove the retaining or waxing screw and then carefully remove the wax framework from the analogs. Invest, burnout and cast the framework using a low, medium or high noble alloy (see page 14 for casting alloy specifications). Chemically divest and finish the metal framework. Return to the restorative dentist for the metal framework try in.





### Restorative Dentist

9.   Remove the healing caps from the abutments using a .048" Large Hex Driver [PHD02N or PHD03N]. To help prevent accidental swallowing, thread floss through the spinner of the driver. Place the framework onto the abutments. Thread a Low Profile Gold-Tite Retaining Screw [LPCGSH] into the posterior-most abutment and finger-tighten using the .048" Large Hex Driver. Radiograph the interface to verify an accurate fit. Repeat after removing the screw and placing it into the anterior-most abutment. If the framework does not fit the abutments; cut and index the framework. Return the framework to the laboratory for soldering or welding. Repeat the metal framework try in to make sure an accurate and complete fit is obtained. Take another radiograph to access the fit between the framework and abutments. Immediately replace the healing caps back onto the abutments.



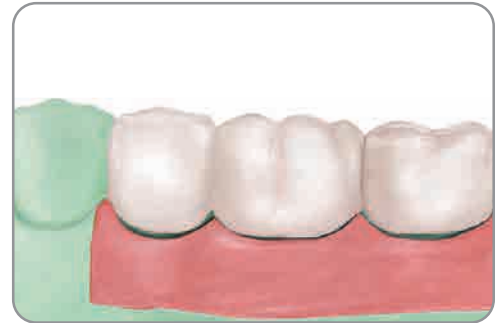

### Laboratory

10.   Place the verified framework back onto the analogs in the cast and thread Low Profile Titanium Retaining Screws [LPCTSH] or Low Profile Abutment Waxing Screws [LPCWS] into the implant analogs and finger-tighten using a .048" Large Hex Driver [PHD02N or PHD03N]. Opaque and build porcelain on the framework. Stain and glaze the porcelain. Polish the Gold Cylinders with polishing protectors in place.



### Restorative Dentist

11.   Remove the healing caps from the abutments using a .048" Large Hex Driver [PHD02N or PHD03N]. To help prevent accidental swallowing, thread floss through the spinner of the driver. Place the prosthesis onto the abutments. Thread Low Profile Gold-Tite Retaining Screws [LPCGSH] into the abutments and finger-tighten using the .048" Large Hex Driver. Radiograph the interface on the abutments to verify an accurate fit. Verify the interproximal contacts and the occlusion. Torque the screws to 10 Ncm using a .048" Large Hex Driver Tip [RASH3N or RASH8N] with a torque device [L-TIRW or HTD-C]. Place protective material into the screw access openings. Seal the access openings with temporary filling material and composite resin. Make any necessary occlusal adjustments.



## Conical Abutments

### Considerations:

- Single and multiple-unit porcelain-fused-to-metal, screw-retained restorations
- Minimum interarch space of 7 mm
- Minimum tissue height of 2 mm
- Angle correction up to 25°

### Specifications:

- Titanium Alloy (Certain® Straight Abutments and all 15° Pre-Angled Abutments)
- Commercially Pure Titanium (External Hex Straight Abutments)

### Instrumentation Needed:



- .048" Large Hex Driver [PHD02N or PHD03N]
- Abutment Driver Tip [RASA3]
- Torque Device [L-TIRW or HTD-C]
- .048" Large Hex Driver Tip [RASH3N or RASH8N]
- Conical Abutment Healing Cap [MHC33 or CS2x0]
- .048" Large Hex Driver [PHD02N or PHD03N]
- Titanium Hexed Retaining Screw [TSH30]
- Waxing Screw [WSK10 or WSK15]
- .048" Large Hex Driver [PHD02N or PHD03N]
- Hexed Gold-Tite Retaining Screw [GSHx0]

## Conical Abutment | Single-Unit | Indirect Technique

### Surgeon or Restorative Dentist



1. Select the proper Conical Abutment by matching it to the Emergence Profile (EP) and the restorative platform of the healing abutment and the implant platform diameter. Select the abutment collar height and angle (0°, 17° or 25°) by measuring the height of the healing abutment above the tissue on the buccal surface, **not** including the domed portion. Subtract this measurement from the total height of the healing abutment and then subtract an additional 2 mm. See pages 15-16 for the Abutment Selection Guide.
2. Remove the healing abutment from the implant using a .048" Large Hex Driver [PHD02N or PHD03N]. To help prevent accidental swallowing, thread floss through the spinner of the driver.



3.   Activate the abutment fingers using the Certain QuickSeat Activator Tool (see page 11). Place the abutment into the implant, line up the hex and press firmly until hearing and feeling an audible and tactile click.



Or

-  Place the abutment onto the implant, engaging the hex.

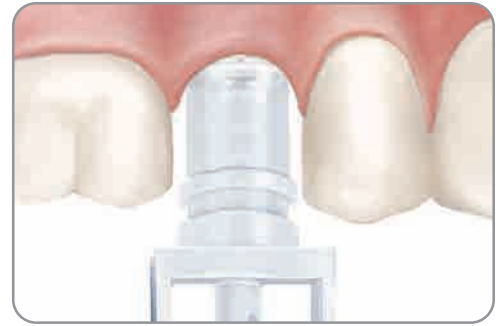

-   Thread the Conical Abutment Screw into the implant by turning the spindle on the ASYST Tool and finger-tighten. Remove the ASYST Tool.

If correcting an angle using a Conical 17° or 25° Angled Abutment, place the abutment in or on the implant hex to correct angulation while holding onto the delivery tool. Insert the driver tip into the abutment screw and finger-tighten into the implant.



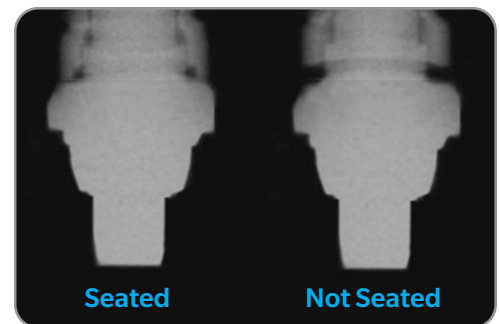

4.   Radiograph the interface to verify complete seating of the abutment on the implant. Place the film perpendicular to the interface of the abutment on the implant.



5.   **Straight Abutments:** Torque the abutment screw to 20 Ncm using an Abutment Driver Tip [RASA3] with a torque device [L-TIRW or HTD-C].



Or

-   **Angled Abutments:** Torque the abutment screw to 20 Ncm using a .048" Large Hex Driver Tip [RASH3N or RASH8N] with a torque device [L-TIRW or HTD-C].

If the surgeon places the abutment, a Conical Abutment Healing Cap [MHC33 or CS2x0] is threaded onto the abutment and torque to 10 Ncm using the .048" Large Hex Driver [PHD02N or PHD03N] with a torque device [L-TIRW or HTD-C]. To help prevent accidental swallowing, thread floss through the spinner of the driver.



#### Restorative Dentist

6.   Follow the steps for abutment level impressions on pages 18-20 for the Pick-Up Technique and pages 21-23 for the Twist Lock Transfer Technique.

**NOTE:** Conical Abutment Impression Copings do not require activation, as there are no fingers on the copings.



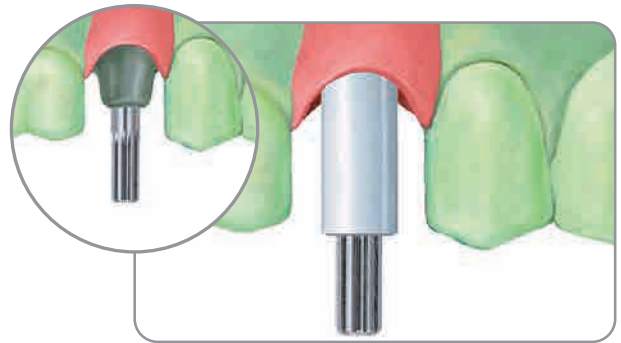

## Laboratory

7.  Place a Gold Hexed Conical Cylinder onto the Conical Analog. Thread a Titanium Hexed Retaining Screw [TSH30] or Waxing Screw [WSK10 or WSK15] into the analog and finger-tighten using a .048" Large Hex Driver [PHD02N or PHD03N]. Reduce or adjust the plastic sleeve as necessary. Wax the porcelain-fused-to-metal framework (PFM) to the waxing sleeve.

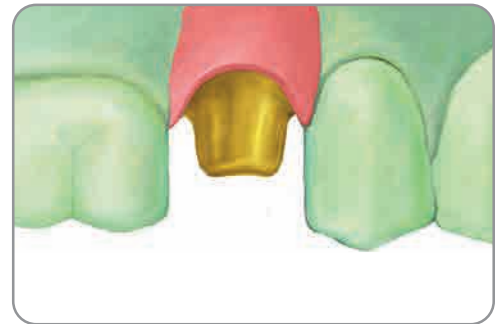

8.  Remove the retaining or waxing screw and then carefully remove the waxed framework from the analog. Invest, burnout and cast the waxed framework using a low, medium or high noble alloy (see page 14 for casting alloy specifications). Chemically divest and finish the restoration.



9.  Place the metal framework onto the analog in the cast, thread the retaining or waxing screw into the analog and finger-tighten. Opaque and build porcelain on the metal framework. Stain and glaze the porcelain. Polish the Gold Castable Cylinder with a polishing protector in place.

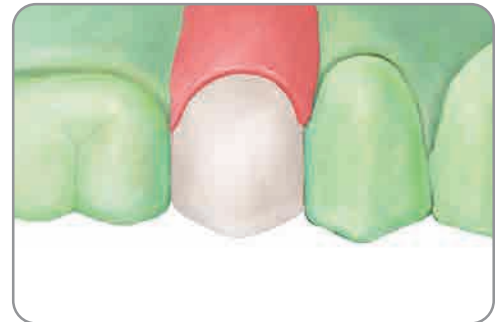

## Restorative Dentist

10.  Remove the healing cap from the abutment using a .048" Large Hex Driver [PHD02N or PHD03N]. To help prevent accidental swallowing, thread floss through the spinner of the driver. Place the crown on the abutment, engaging the hex. Thread a Hexed Gold-Tite Retaining Screw [GSHx0] into the abutment and finger-tighten using the .048" Large Hex Driver. Radiograph the interface to verify an accurate fit. Check the interproximal contacts, marginal fit and occlusion. Torque the screw to 10 Ncm using a .048" Large Hex Driver Tip [RASH3N or RASH8N] with a torque device [L-TIRW or HTD-C].





11.  Place protective material into the screw access opening. Seal the access opening with temporary filling material and composite resin. Make any necessary occlusal adjustments.





## Conical Abutment | Multiple-Unit | Indirect Technique

(See page 64 for considerations and specifications)



### Surgeon or Restorative Dentist

1.   Select the proper Conical Abutment by matching it to the Emergence Profile (EP) and the restorative platform of the healing abutment and the implant platform diameter. Select the abutment collar height and angle (0°, 17° or 25°) by measuring the height of the healing abutment above the tissue on the buccal surface, not including the domed portion. Subtract this measurement from the total height of the healing abutment and then subtract an additional 2 mm. See pages 15-16 for the Abutment Selection Guide.



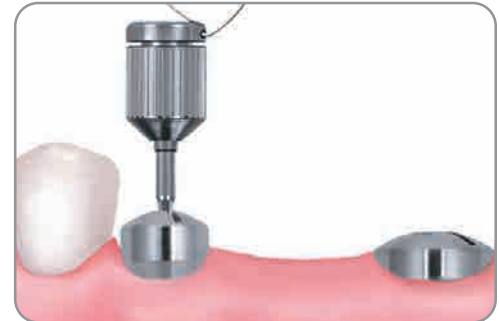

2.   Remove the healing abutments from the implants using a .048" Large Hex Driver [PHD02N or PHD03N]. To help prevent accidental swallowing, thread floss through the spinner of the driver.



3.   Activate the abutment fingers using the Certain QuickSeat Activator Tool (see page 11). Place the abutments into the implants, line up the hex and press firmly until hearing and feeling an audible and tactile click.



Or

 Place the abutment onto the implants, engaging the hex.

  Thread Conical Abutment Screws into the implants by turning the spindle on the ASYST Tool and finger-tighten. Remove the ASYST Tool.

If correcting an angle using the Conical 17° or 25° Angled Abutment, place the abutment in or on the implant hex to correct angulation while holding onto the delivery tool. Insert the driver tip into the abutment screw and finger-tighten into the implant



4.   Radiograph the interfaces to verify complete seating of the abutments on all of the implants. Place the film perpendicular to the interface of the abutments on the implants.

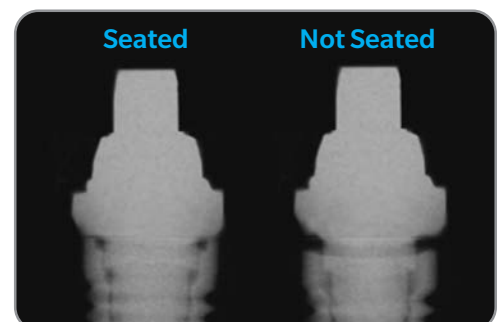





5.  **Straight Abutments:** Torque the abutment screw to 20 Ncm using an Abutment Driver Tip [[RASA3](#)] with a torque device [[L-TIRW](#) or [HTD-C](#)].

Or

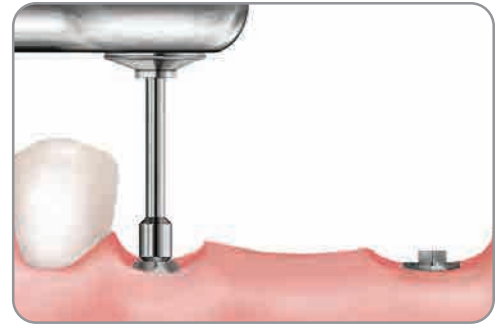
 **Angled Abutments:** Torque the abutment screws to 20 Ncm using a .048" Large Hex Driver Tip [[RASH3N](#) or [RASH8N](#)] with a torque device [[L-TIRW](#) or [HTD-C](#)]. If the surgeon places the abutments, a Conical Abutment Healing Cap [[MHC33](#) or [CS2x0](#)] is threaded onto the abutments and torque to 10 Ncm using the .048" Large Hex Driver [[PHD02N](#) or [PHD03N](#)] with a torque device [[L-TIRW](#) or [HTD-C](#)]. To help prevent accidental swallowing, thread floss through the spinner of the driver.



#### Restorative Dentist

6.  Follow the steps for abutment level impressions on pages 18-20 for the Pick-Up Technique and pages 21-23 for the Twist Lock Transfer Technique.

**NOTE:** Conical Abutment Impression Copings do not require activation, as there are no fingers on the copings.



#### Laboratory

7.  Place the Non-Hexed Conical Gold Cylinders onto the Conical Analogs. Thread Titanium Hexed Retaining Screws [[TSH30](#)] or Waxing Screws [[WSK10](#) or [WSK15](#)] into the analogs and finger-tighten using a .048" Large Hex Driver [[PHD02N](#) or [PHD03N](#)]. Reduce or adjust the plastic sleeves as necessary. Wax the porcelain-fused-to-metal (PFM) framework to the waxing sleeves.

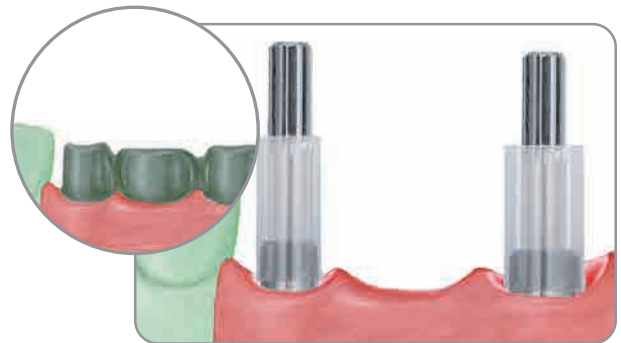

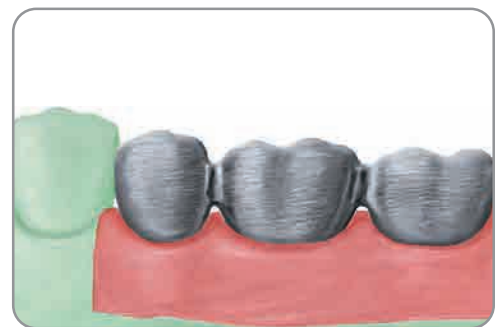

8.  Remove the retaining or waxing screws and then carefully remove the wax framework from the analogs. Invest, burnout and cast the framework using a low, medium or high noble alloy (see page 14 for casting alloy specifications). Chemically divest and finish the metal framework. Return to the restorative dentist for the metal framework try in.







## Restorative Dentist

9.   Remove the healing caps from the abutments using a .048" Large Hex Driver [PHD02N or PHD03N]. To help prevent accidental swallowing, thread floss through the spinner of the driver. Place the framework onto the abutments. Thread a Hexed Gold-Tite Retaining Screw [GSHx0] into the posterior-most abutment using the .048" Large Hex Driver. Radiograph the interface to verify an accurate fit. Repeat after removing the screw and placing it into the anterior-most abutment. If the framework does not fit the abutments; cut and index the framework. Return the framework to the laboratory for soldering or welding. Repeat the metal framework try in to make sure an accurate is obtained. Take additional radiographs as necessary to verify an accurate fit. Immediately replace the healing caps back onto the abutments.



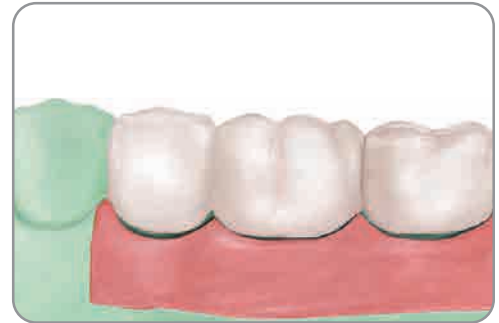

## Laboratory

10.   Place the verified framework back onto the Conical Analogs in the cast, thread retaining or waxing screws into the analogs and finger-tighten. Opaque and build porcelain on the framework. Stain and glaze the porcelain. Polish the Gold Cylinders with polishing protectors in place.



## Restorative Dentist

11.   Remove the healing caps from the abutments using a .048" Large Hex Driver [PHD02N or PHD03N]. To help prevent accidental swallowing, thread floss through the spinner of the driver. Place the prosthesis onto the abutments. Thread Hexed Gold-Tite Retaining Screws [GSHx0] into the abutments and finger-tighten using the .048" Large Hex Driver. Radiograph the interface to verify an accurate fit. Verify the interproximal contacts and the occlusion. Torque the screws to 10 Ncm using a .048" Large Hex Driver Tip [RASH3N or RASH8N] with a torque device [L-TIRW or HTD-C]. Place protective material into the screw access openings. Seal the access openings with temporary filling material and composite resin. Make any necessary occlusal adjustments.



# Denture Conversion to Fixed Prosthesis Techniques

## QuickBridge® Provisional Components | Direct Technique

### Restorative Dentist

1.  Prior to placing the abutments, make an interocclusal registration with the patient in centric occlusion. This is made with the patient's existing denture.

**NOTE:** One piece interocclusal registrations (one U-shaped interocclusal record) are easier to handle than two individual (right and left segments) interocclusal registrations. Two interocclusal registrations can be mixed up (right and left; up and down). One piece interocclusal registrations are much easier to align correctly in the mouth.



2.  The Low Profile Abutments should be torqued to 20 Ncm using an Abutment Driver Tip [RASA3] with a torque device [L-TIRW or HTD-C]. Place a QuickBridge Titanium Cylinder onto each of the abutments and finger-tighten the QuickBridge Screws using a .048" Large Hex Driver [PHD02N or PHD03N]. To help prevent accidental swallowing, thread floss through the spinner of the driver. Torque the cylinder retaining screws to 10 Ncm using a .048" Large Hex Driver Tip [RASH3N or RASH8N] with a torque device [L-TIRW or HTD-C]. Place quick-setting impression material onto the intaglio surface of the denture, insert it in the mouth and press lightly over the cylinder assembly to mark their locations. Allow the impression material to set per the manufacturer's instructions. The patient should be in centric occlusion during this step; the midline should be consistent with the facial midline; the occlusal plane should be horizontal.



3.  Remove the denture from the mouth. The locations of the cylinders will be identified in the impression material. Using the indentation in the impression material as a guide, drill holes completely through the denture base and denture teeth with a large round bur. Enlarge the holes with an acrylic bur so that the QuickBridge Components do not interfere with the denture base when the denture is seated intraorally. Make sure the vertical dimension of occlusion has not been changed.

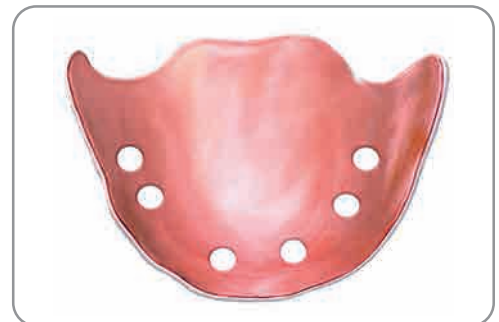

4.  Snap the QuickBridge Caps onto the QuickBridge Titanium Cylinders. Try in the denture over the QuickBridge Caps to verify that there are no interferences when it is completely seated. Place self-curing acrylic resin into the retention facets of the QuickBridge Caps and fill the relieved areas of the denture with acrylic resin. Seat the denture over the QuickBridge Caps and have the patient close lightly into centric occlusion using the interocclusal registration. Verify that the denture is completely seated and that the vertical dimension of occlusion has not been changed. Allow the acrylic resin to set per the manufacturer's instructions. The maxillary midline should be consistent with the facial midline.

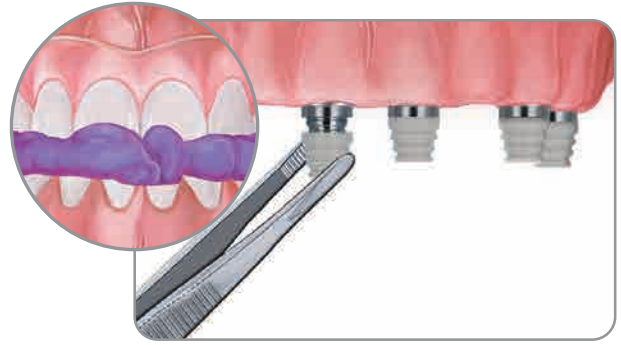

**NOTE:** If this is performed immediately following implant placement for immediate occlusal loading, cut and place a rubber dam around the QuickBridge Titanium Cylinders prior to relining the denture with acrylic resin.

5.  Remove the denture from the mouth. The QuickBridge Caps will remain inside the denture. Remove the palate and flanges from the denture using an acrylic bur. Fill in any voids around the QuickBridge Caps with self-curing acrylic resin. Be careful not to let any resin flow into the QuickBridge Caps which will interfere with seating over the QuickBridge Titanium Cylinders. Finish and polish the denture. Place a small amount of temporary cement into the QuickBridge Caps and seat the provisional prosthesis onto the QuickBridge Titanium Cylinders. Have the patient close lightly into centric occlusion. Remove excess cement from around the margin areas of each cap. Allow the cement to set per the manufacturer's instructions. Make any necessary occlusal adjustments.



# Fabrication of Provisional to Fixed Prosthesis Techniques

## QuickBridge Provisional Restoration | Indirect Technique

### Restorative Dentist

1.  Make an impression of the patient's existing denture and the opposing arch. Make an occlusal registration with quick-setting polyvinyl siloxane impression material.

### Laboratory

2.  Pour stone casts of the impressions. Articulate the stone casts using the interocclusal registration.

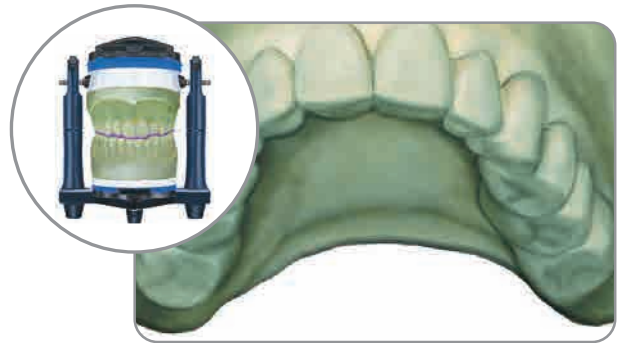

3.  Make a vacuum-formed template over the stone cast. A 2 mm thick flexible vacuum-formed material is recommended. Remove the template from the stone cast and trim away excess material. Leave the palate and flanges on the template. Make an interocclusal registration between the template and the opposing cast using the articulator.



4.  Fill the tooth portion of the vacuum-formed template with impression material and place it in the mouth over the Low Profile Abutments. Have the patient close lightly into the interocclusal registration and allow the impression material to set. Remove the impression material from the template. Place the impression material replica of the teeth in the mouth and verify the occlusion and tooth position. Set aside the replica of the teeth for the laboratory to use as a guide when fabricating the definitive restoration.

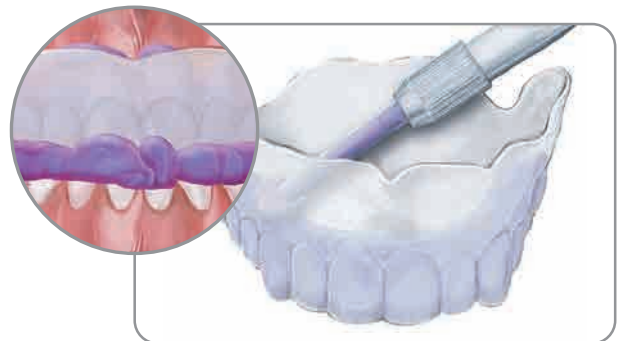

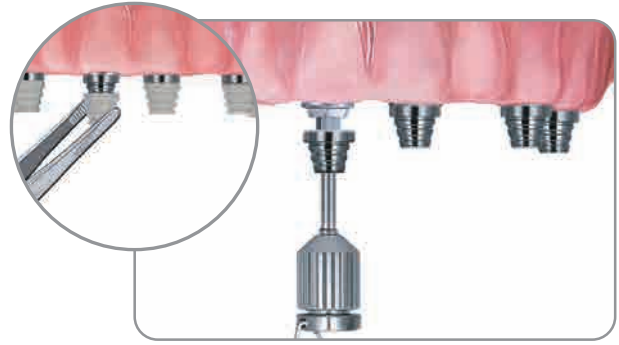

5.  The Low Profile Abutments should be torqued to 20 Ncm using an Abutment Driver Tip [RASA3] with a torque device [L-TIRW or HTD-C]. Place a QuickBridge Titanium Cylinder onto each of the abutments and finger-tighten the QuickBridge Screws using a .048" Large Hex Driver Tip [PHD02N or PHD03N]. To help prevent accidental swallowing, thread floss through the spinner of the driver. Torque the cylinder retaining screws to 10 Ncm using a .048" Large Hex Driver Tip [RASH3N or RASH8N] with a torque device [L-TIRW or HTD-C]. Place quick-setting impression material onto the intaglio surface of the denture, insert it in the mouth and press lightly over the cylinder assembly to mark their locations. Allow the impression material to set per the manufacturer's instructions. The patient should be in centric occlusion during this step; the midline should be consistent with the facial midline; the occlusal plane should be horizontal.

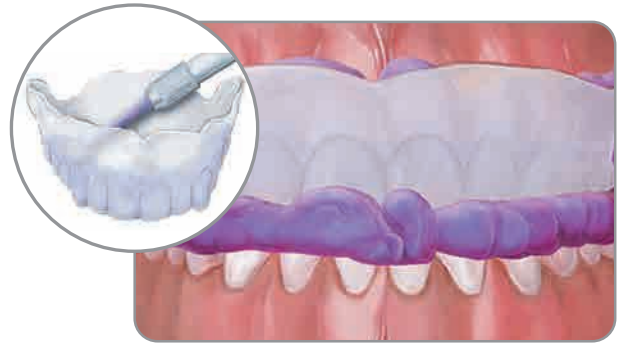

6.  Add self-curing acrylic resin into the retention facets of the QuickBridge Caps and into the tooth portion of the template. Place the template into the mouth over the QuickBridge Caps and have the patient close lightly into the interocclusal registration. Allow the acrylic resin to set per the manufacturer's instructions.

**NOTE:** Irrigate with water during polymerization. Be aware of the amount of heat generated by the acrylic resin during setting and polymerization.



7.  Remove the template from the mouth. The caps will remain in the acrylic resin. Be careful to not let any resin flow into the caps that will interfere with seating over the cylinders. Remove the provisional prosthesis from the template. Remove the excess acrylic resin from around the margin areas and fill in any voids. Finish the provisional restoration to the desired contour and polish.



8.  Place the provisional restoration into the mouth and snap the caps onto the cylinders. Verify the fit and aesthetics. Make any necessary occlusal adjustments. Remove the provisional restoration. Place a small amount of temporary cement into the caps and seat the provisional prosthesis on the cylinders and have the patient close lightly into occlusion. Remove excess cement from around the margin areas of each cap. Allow the cement to set per the manufacturer's instructions. Make any necessary occlusal adjustments.

**NOTE:** If this is performed immediately following implant placement for immediate occlusal loading, cut and place a rubber dam around the cylinders.



# Bar-Supported Overdenture

## Standard Abutment Bar

### Considerations:

- Multiple implant, bar-retained and removable overdentures
- Minimum space for bar construction is 9-11 mm
- Maximum divergence of 30°

### Specifications:

- Titanium Alloy (Certain internal connection)
- Commercially Pure Titanium (External Hex connection)

### Instrumentation Needed:

- .048" Large Hex Driver [PHD02N or PHD03N]
- Abutment Driver Tip [RASA3]
- Torque Device [L-TIRW or HTD-C]
- Transfer Impression Coping Driver [ICD00]
- Waxing Screws [WSK10 or WSK15]
- Hexed Gold-Tite Retaining Screw [GSHx0]
- .048" Large Hex Driver Tip [RASH3N or RASH8N]

### Surgeon or Restorative Dentist

1.  Select the proper Standard Abutment collar height by measuring the height of the healing abutment above the tissue on the buccal surface, **not** including the domed portion. Subtract this measurement from the total height of the healing abutment and then add 1 mm. The Standard Abutment seating surface should match the implant platform. See pages 15-16 for the Abutment Selection Guide.



2.  Remove the healing abutments from the implants using a .048" Large Hex Driver [PHD02N or PHD03N]. To help prevent accidental swallowing, thread floss through the spinner of the driver.

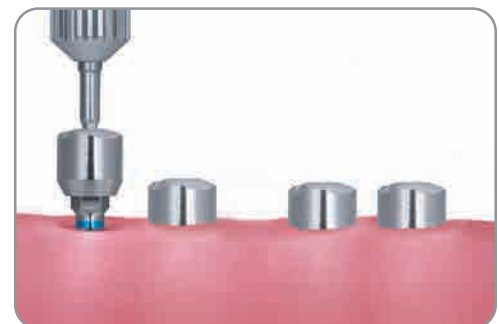





3.  Place the Standard Abutment into the implant, thread into place and finger-tighten.

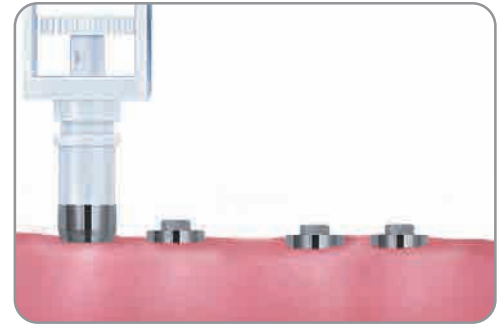

Or

 Place the Standard Abutment onto the implant engaging the hex, thread the Standard Abutment Screw into the implant by turning the spindle on the ASYST Tool and finger-tighten. Remove the ASYST Tool.

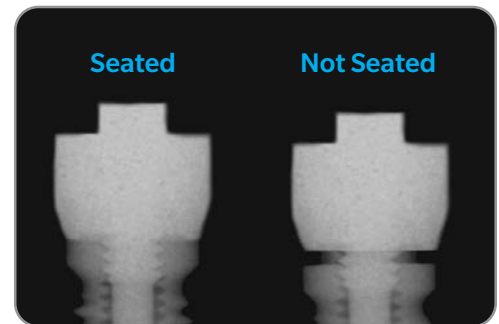

4.   Radiograph the interfaces to verify complete seating of the abutments on all of the implants. Place the film perpendicular to the interface of the abutment on the implant.



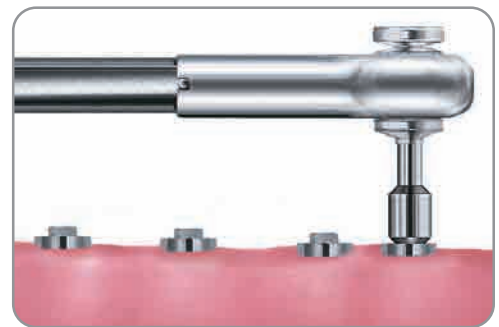

5.   Torque the Standard Abutment Screws into the implants to 20 Ncm using an Abutment Driver Tip [[RASA3](#)] with a torque device [[L-TIRW](#) or [HTD-C](#)]. If the surgeon places the abutments, and torque to 10 Ncm Standard Abutment Healing Caps are threaded onto the abutments using a .048" Large Hex Driver [[PHD02N](#) or [PHD03N](#)] with a torque device [[L-TIRW](#) or [HTD-C](#)]. To help prevent accidental swallowing, thread floss through the spinner of the driver. The patient's existing denture is then relieved to be supported by the abutments. A tissue conditioning material is sometimes necessary for retention and support of the overdenture. The healing caps are not designed to provide retention for the overdenture.



## Pick-Up Impression Technique

(See page 78 and 79 for Transfer Impression Technique)

### Restorative Dentist Pick-Up Technique

- 6a.   Place the Standard Abutment Pick-Up Impression Copings onto the abutments. Thread coping screws into the abutments and finger-tighten using a .048" Large Hex Driver [[PHD02N](#) or [PHD03N](#)]. To help prevent accidental swallowing, thread floss through the spinner of the driver. Visually verify all copings are completely seated on the abutments. Impression copings may be splinted prior to the definitive impression. Radiograph the interface to verify complete seating of the copings on the abutments.

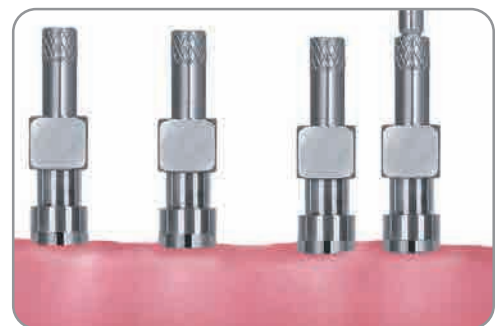





- 7a.  A custom or stock **open** top impression tray is used for the Pick-Up Impression Technique. Cut small holes into the tray for the screws to protrude through. Try in the tray to verify that the screw heads are visible through the openings.

**NOTE:** If the impression is to be used to fabricate the overdenture, a custom impression tray should be made.

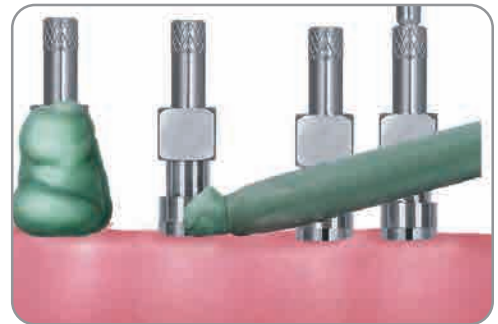

- 8a.  Syringe light viscosity impression material around the impression copings.



-  9a. Load the impression tray with medium or heavy viscosity impression material and seat it in the mouth. Wipe impression material off the top of the screws before it sets. Allow the impression material to set per the manufacturer's instructions.



-  10a. After the impression material has set, unscrew and remove the Pick-Up Impression Coping Screws using the .048" Large Hex Driver [[PHD02N](#) or [PHD03N](#)]. To help prevent accidental swallowing, thread floss through the spinner of the driver. Remove the impression from the mouth.



- 11a.  Verify that the impression material has completely adapted around each of the copings and that the copings are not mobile within the impression. If any copings are loose or the impression material is on the seating surface of the copings, the impression should be repeated.

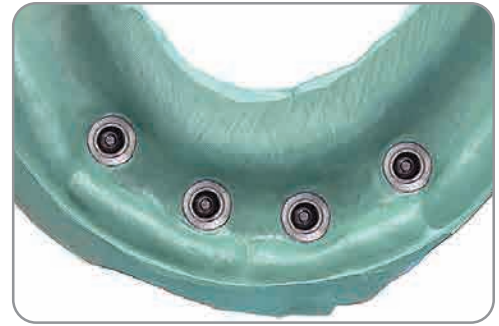

- 12a.  Immediately replace the healing caps back onto the abutments using the .048" Large Hex Driver using the .048" Large Hex Driver [PHD02N or PHD03N]. To help prevent accidental swallowing, thread floss through the spinner of the driver. Reline the patient's existing denture with a soft reline material over the abutments and healing caps.

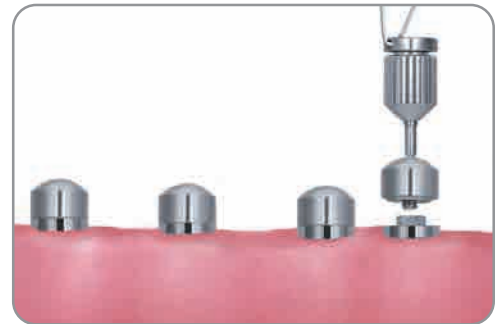

Laboratory

- 13a.  Place the Standard Abutment Laboratory Analogs into the impression copings and hold them in position while tightening the screws. Verify that the analogs are completely seated.

**NOTE:** In some cases, it may be necessary to place soft-tissue replication material around the impression coping/analogs prior to pouring the stone cast. Check with your laboratory for specific procedures.

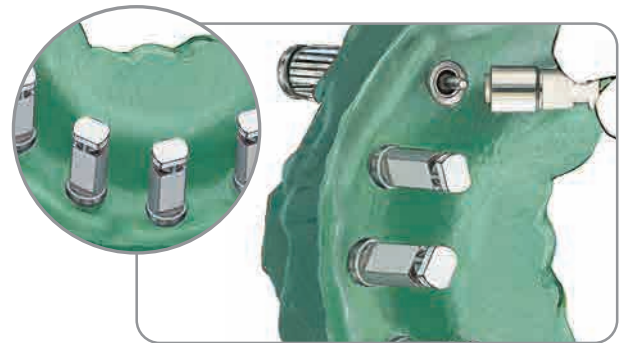

- 14a.  Pour the cast in die stone. After the stone has set, loosen the screws until these disengage from the analogs using a .048" Large Hex Driver [PHD02N or PHD03N]. Remove the impression from the stone cast. Go to Step 15.

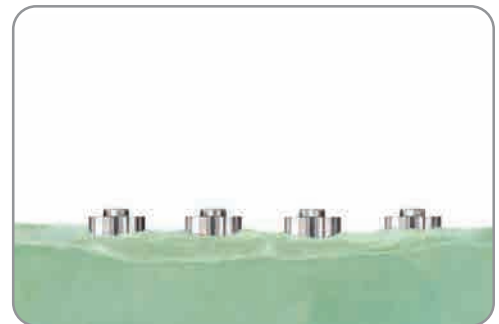

## Transfer Impression Technique

### Restorative Dentist

6b.  Thread Standard Abutment Transfer Copings into the abutments and finger-tighten using a Transfer Impression Coping Driver [ICD00]. To help prevent accidental swallowing, thread floss through the spinner of the driver. Visually verify that all copings are completely seated on the abutments.

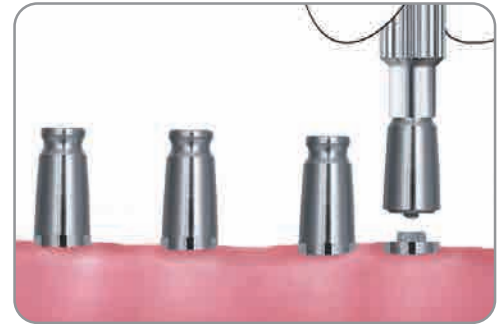

7b.  A custom or stock **closed** top impression tray is used for the transfer impression technique. Allow for approximately 2 mm of space between the tray and the top of the copings. The copings are 9 mm in height.

**NOTE:** If the impression is to be used to fabricate the overdenture, a custom impression tray should be made.



8b.  Syringe light viscosity impression material around the impression copings. Allow the impression material to set per the manufacturer's instructions.



9b.  Load the impression tray with medium or heavy viscosity impression material and seat it in the mouth. Allow the impression material to set per the manufacturer's instructions.



- 10b.  After the impression material has set, remove the impression from the mouth. The transfer impression copings will remain on the abutments in the mouth. Verify that the material has completely adapted around each of the copings.



- 11b.  Remove the copings from the abutments with an Impression Coping Driver [ICD00]. To help prevent accidental swallowing, thread floss through the spinner of the driver.

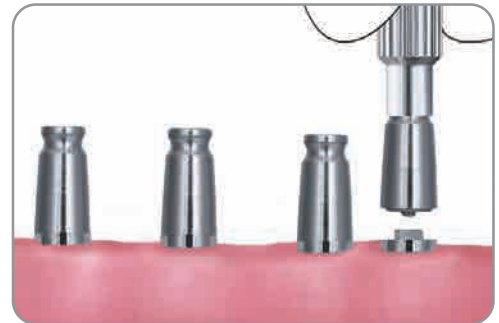

- 12b.  Immediately replace the healing caps back onto the abutments using the .048" Large Hex Driver using the .048" Large Hex Driver [PHD02N or PHD03N]. To help prevent accidental swallowing, thread floss through the spinner of the driver. Reline the patient's existing denture with a soft reline material over the abutments and healing caps.

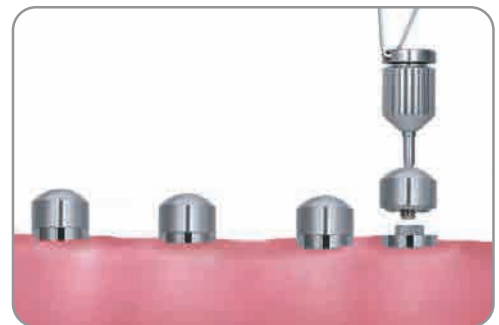

#### Laboratory

- 13b.  Screw the Transfer Impression Copings onto the Standard Abutment Analogs and verify that these are completely seated. Holding on to the analog, press each transfer coping firmly into the impression. The coping is completely seated when the retentive groove engages.



- 14b.  Pour the cast in die stone. After the stone has set, remove the impression from the cast. Unscrew the Transfer Impression Copings from the analogs. **Go to Step 15.**

**NOTE:** In some cases, it may be necessary to place soft-tissue replication material around the impression coping/analogs prior to pouring the stone cast. Check with your laboratory for specific procedures.

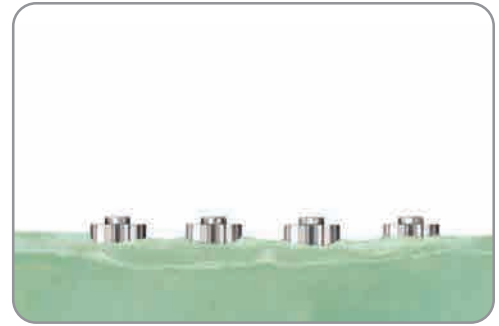

15.  Place the Standard Abutment Gold Cylinder or Non-Hexed Castable Cylinders onto the Standard Abutment Analogs. Thread Waxing Screws [WSK10 or WSK15] into the analogs and finger-tighten using a .048" Large Hex Driver [PHD02N or PHD03N]. Non-Hexed Pick-up Impression Copings may also be used for this step. Fabricate a verification index by luting the plastic sleeves together using a low expansion light cure composite resin or autopolymerizing acrylic resin. It is often helpful to fabricate a record base and occlusion rim at this step to facilitate jaw relation records.

**NOTE:** If using autopolymerizing acrylic resin, allow at least 24 hours to polymerize prior to using.

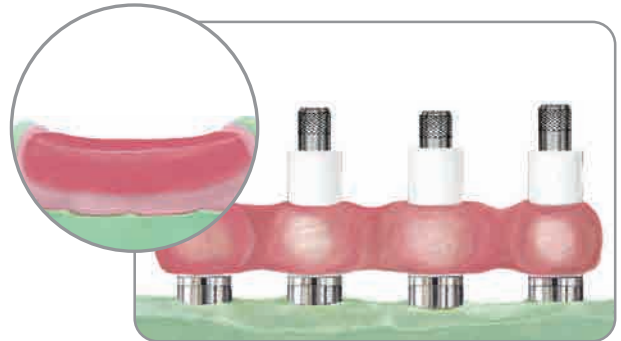

#### Restorative Dentist

16.  Remove the healing caps from the abutments using a .048" Large Hex Driver [PHD02N or PHD03N]. To help prevent accidental swallowing, thread floss through the spinner of the driver. Place the record base and occlusion rim in the mouth, over the abutments. Make the interocclusal records. Place the verification index onto the abutments. Place a Hexed Gold-Tite Retaining Screw [GSHx0] or Waxing Screw [WSK10 or WSK15] into one posterior-most cylinder and finger-tighten. Visually verify that all cylinders are completely seated on the abutments. Remove the screw and place it into the opposite posterior-most cylinder and repeat. If a fit discrepancy is found, section the index into individual segments and reassemble intraorally. Splint the segments together with autopolymerizing acrylic resin and allow it to set. Remove the index and return it to the laboratory for re-fitting of the master cast. Immediately replace the healing caps back onto the abutments.

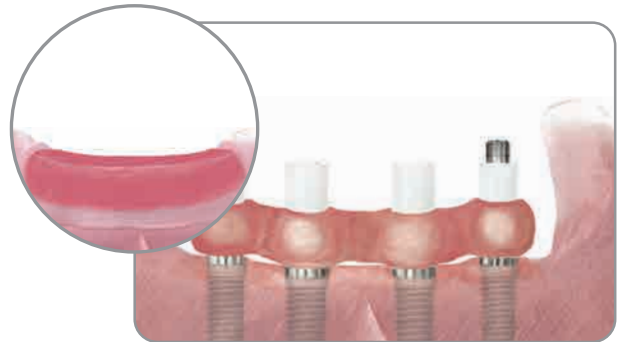

#### Laboratory

17.  Verify that the analog positions on the cast are accurate using a verification index. Articulate casts using the interocclusal record. Set the denture teeth on the record base and wax for try in. If the verification index was corrected, the corrected index is used to identify inaccurate analogs in the cast. Take this index back to the cast and identify the inaccurate analog(s). Remove the inaccurate analog(s) from the cast and attach it to the verification index. Re-seat the index on the other remaining analogs into the cast. Verify that the analogs does not touch the stone of the cast. Inject a mix of die stone to re-attach the analogs back into the cast.



**Restorative Dentist**

18.  Place the wax denture into the mouth. Verify the occlusion, aesthetics and phonetics. Make any necessary adjustments. If major adjustments are necessary, make a new interocclusal record and return it to the laboratory for a new articulator mounting, wax denture set-up and try in.

**Laboratory**

19.  For a cast bar, make a plaster or silicone matrix of the verified wax denture. This will facilitate setting the teeth in their proper positions after the casting has been made.

Or

If the clinician and/or laboratory technician would like to use CAD/CAM technology, request a BellaTek Bar. See the BellaTek Bars & Frameworks Manual (ZBINST868).



20.  Carefully remove the Standard Abutment Gold Cylinders or Non-Hexed Castable Cylinders from the verification index. Place the cylinders onto the analogs, thread Waxing Screws [WSK10 or WSK15] into the analogs and finger-tighten. Adjust the height of the sleeves as necessary. Wax the bar patterns (and attachments, if used) to the waxing sleeves. Use the matrix on the cast to position the bar within the confines of the wax denture teeth.

**NOTE:** Adequate space is required for the bar, attachments, denture base and denture teeth.

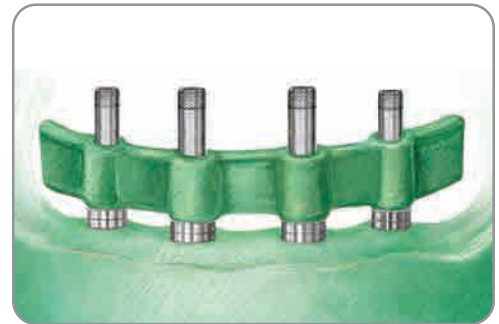

21.  Remove the bar wax pattern from the cast. Invest, burnout and cast the bar in a low, medium or high noble alloy (see page 14 for casting alloy specifications). Chemically divest, finish and polish the bar with polishing protectors in place. Return the bar to the restorative dentist for try in and fit verification.



**Restorative Dentist**

22.  Remove the healing caps from the abutments using a .048" Large Hex Driver [PHD02N or PHD03N]. To help prevent accidental swallowing, thread floss through the spinner of the driver. Place the bar onto the abutments. Thread a Hexed Gold-Tite Retaining Screw [GSHx0] into one posterior-most cylinder and finger-tighten. Visually verify that the bar is completely seated on all of the implants. Remove the screw and place it into the opposite posterior-most cylinder and repeat. If a fit discrepancy is found, cut and index the bar intraorally and return the framework to the laboratory for soldering or welding. Immediately replace the healing caps back onto the abutments.







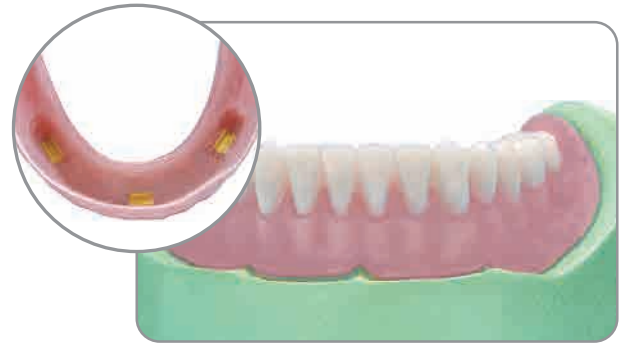

**Laboratory**

23.   Transfer the denture teeth back onto the cast using the matrix and wax the denture for processing. Flask the waxed denture and boil out. Separate the flask and attach the bar to the analogs in the cast using retaining screws. Block out all undercuts and access openings with wax. Place the clips and/or other attachments onto the bar. Process and finish the denture following conventional procedures.

**Restorative Dentist**

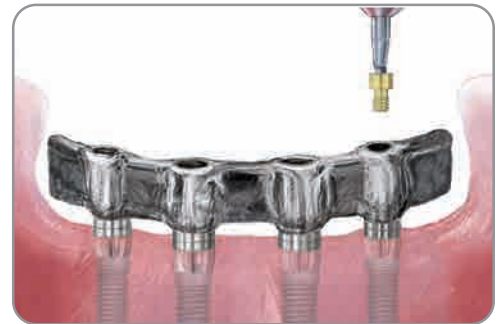
24.   Remove the healing caps from the abutments using a .048" Large Hex Driver [PHD02N or PHD03N]. To help prevent accidental swallowing, thread floss through the spinner of the driver. Place the bar onto the abutments. Thread Hexed Gold-Tite Retaining Screws [GSHx0] into the abutments and torque to 10 Ncm using a .048" Large Hex Driver Tip [RASH3N or RASH8N] with a torque device [L-TIRW or HTD-C].



25.   Place the overdenture onto the bar in the mouth and engage the retentive attachments. Make any necessary occlusal or tissue adjustments. Instruct the patient on insertion, removal, maintenance of the prosthesis and oral hygiene.





## UCLA Abutment Bar

### Considerations:

- Multiple implant bar-retained and removable overdentures
- Minimum space for bar construction is 9-11 mm
- Maximum angulation correction of 30°

### Specifications:

- Machined Gold Alloy Cylinder With Plastic Unitube

### Instrumentation Needed:

- Screws [MUNITS, ILRGHT or UNITS]
- Waxing Screws [IWSU30 or WSU30]
- .048" Large Hex Driver [PHD02N or PHD03N]
- Certain Gold-Tite Large Hexed Screw [ILRGHG]
- Gold-Tite Square Screw [UNISG]
- Square Driver [PSQD0N or PSQD1N]
- Torque Device [L-TIRW or HTD-C]

### Restorative Dentist

1.  Follow the steps for abutment level impressions on pages 18-20 for the Pick-Up Technique and pages 21-23 for the Twist Lock Transfer Technique.





### Laboratory

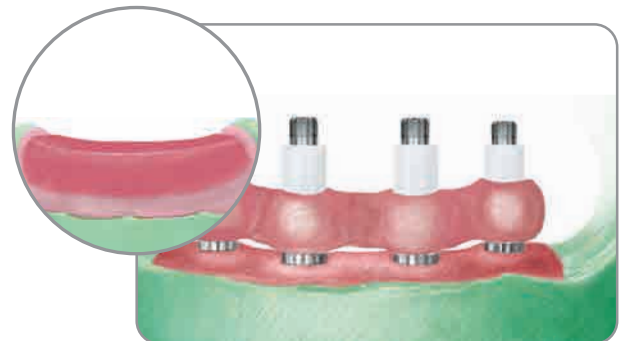

2.  Place the Non-Hexed Gold UCLA Abutments or Castable UCLA Abutments onto the implant analogs. Thread Try-in Screws [MUNITS, ILRGHT or UNITS] or Waxing Screws [IWSU30 or WSU30] into the implant analogs and finger-tighten using a .048" Large Hex Driver [PHD02N or PHD03N]. Fabricate a verification index by luting the plastic sleeves together using a low expansion light cure composite resin or autopolymerizing acrylic resin. Also, fabricate a record base and occlusion rim.



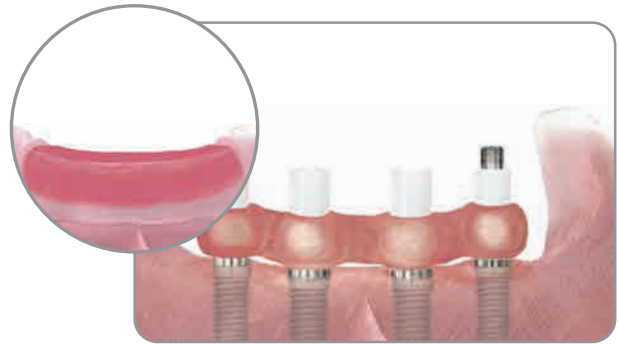

**Restorative Dentist**

3.   Place the record base and occlusion rim over the UCLA Abutments. Make the interocclusal records. Remove the healing abutments from the implants using a .048" Large Hex Driver [PHD02N or PHD03N]. To help prevent accidental swallowing, thread floss through the spinner of the driver. Place the verification index onto the implants. Place a Try-in Screw [MUNITS, ILRGHT or UNITS] or Waxing Screw [WSU30 or WSU30] into one posterior-most UCLA Abutment and finger-tighten using the .048" Large Hex Driver. Visually verify that all cylinders are completely seated onto the implants. Remove the screw and place it into the opposite posterior-most UCLA Abutment and repeat. If a fit discrepancy is found, section the index into individual segments and reassemble intraorally. Splint the segments together with autopolymerizing acrylic resin and allow it to set. Remove the index and return it to the laboratory for re-fitting of the master cast. Immediately replace the healing abutments back onto the implants.



**Laboratory**

4.   Verify that the analog positions on the cast are accurate using a verification index. Articulate casts using the interocclusal record. Set the denture teeth on the record base and wax for try in. If the verification index was corrected, the corrected index is used to identify inaccurate analogs in the cast. Take this index back to the cast and identify the inaccurate analog(s). Remove the inaccurate analog(s) from the cast and attach it to the verification index. Re-seat the index on the other remaining analogs into the cast. Verify that the analog does not touch the stone of the cast. Inject a mix of die stone to re-attach the analog to the cast.

**Restorative Dentist**

5.   Place the wax denture into the mouth. Verify the occlusion, aesthetics and phonetics. Make any adjustments necessary. If major adjustments are necessary, make a new interocclusal record and return it to the laboratory for a new articulator mounting, wax denture set-up and try in.

**Laboratory**

6.   Make a plaster or silicone matrix of the verified wax try-in and remove the denture teeth inside it. Wax and cast the framework consistent with fixed and removable prosthodontic design parameters.

Or

If the clinician and/or laboratory technician would like to use CAD/CAM technology, request a BellaTek Bar. See the BellaTek Bars & Frameworks Manual (ZBINST868).



7.  Carefully remove the UCLA Abutments from the verification index. Place the UCLA Abutments onto the implant analogs. Thread waxing screws into the implant analogs and finger-tighten using a .048" Large Hex Driver [PHD02N or PHD03N]. Adjust the height of the sleeves as necessary. Wax the bar patterns (and attachments, if used) to the waxing sleeves. Use the matrix on the cast to position the bar within the confines of the wax try-in.

**NOTE:** Adequate space (9-11 mm) is required for the implant restorative components, denture base and denture teeth.

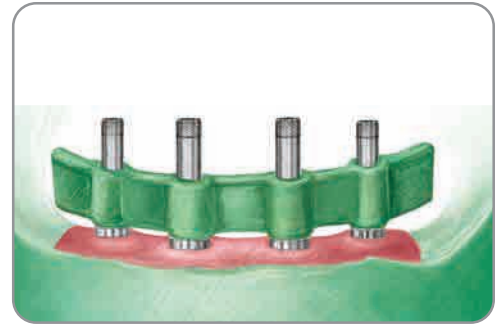

8.  Remove the bar wax-up from the cast. Invest, burnout and cast the bar in a low, medium or high noble alloy (see page 13 for casting alloy specifications). Chemically divest, finish and polish the bar with polishing protectors in place. Return the bar to the restorative dentist for try in and fit verification.

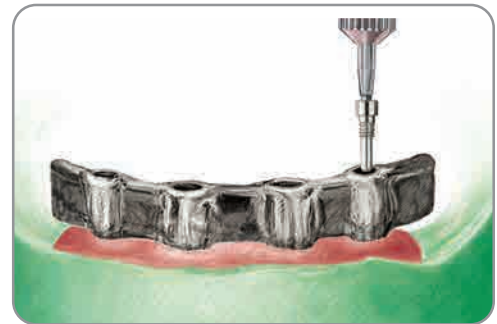

#### Restorative Dentist

9.  Remove the healing abutments from the implants using a .048" Large Hex Driver [PHD02N or PHD03N]. To help prevent accidental swallowing, thread floss through the spinner of the driver. Place the bar onto the implants. Thread a Try-in Screw [MUNITS, ILRGHT or UNITS] into one posterior-most implant. Radiograph the interfaces to verify that the bar is completely seated on all of the implants. Repeat radiograph after removing the screw and placing it into the opposite posterior-most implant. If a fit discrepancy is found, cut and index the bar intraorally for soldering or welding. Immediately replace the healing abutments back onto the implants.

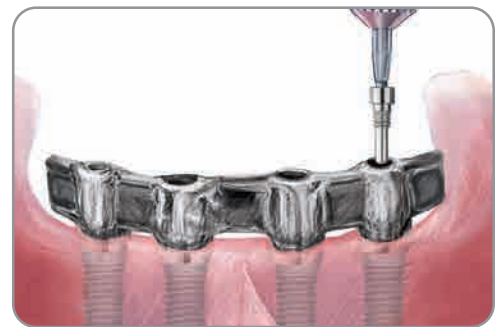



#### Laboratory

10.  Transfer the denture teeth back onto the cast using the matrix and wax the denture for processing. Flask the waxed denture and boil out. Separate the flask and attach the bar to the analogs in the cast using try-in screws. Block out all undercuts and access openings with plaster. Place the clips and/or other attachments onto the bar. Process and finish the denture following conventional procedures.





**Restorative Dentist**



11.   Remove the healing abutments from the implants using a .048" Large Hex Driver [PHD02N or PHD03N]. To help prevent accidental swallowing, thread floss through the spinner of the driver. Place the bar onto the implants.

 Thread a Certain Gold-Tite Large Hexed Screw [ILRGHG] into the implants and finger-tighten using the .048" Large Hex Driver [PHD02N or PHD03N]. To help prevent accidental swallowing, thread floss through the spinner of the driver.

Or

 Thread a Gold-Tite Square Screw [UNISG] into the implants and finger-tighten using a Square Driver [PSQD0N or PSQD1N]. To help prevent accidental swallowing, thread floss through the spinner of the driver.

  Radiograph the interface of the implants to verify an accurate fit. Torque the Certain Gold-Tite Hexed Large Screws to 20 Ncm and Square Gold-Tite Screws to 32-35 Ncm using the proper driver tip with a torque device [L-TIRW or HTD-C].

12.   Place the overdenture onto the bar in the mouth and engage the retentive attachments. Make any necessary occlusal or tissue adjustments. Instruct the patient on insertion, removal, maintenance of the prosthesis and oral hygiene.



# Implant-Retained Fixed Prosthesis

## Low Profile Abutment Fixed Hybrid

### Restorative Dentist

1.  Follow the steps for abutment level impressions on pages 18-20 for the Pick-Up Technique and pages 21-23 for the Twist Lock Transfer Technique.



### Laboratory

2.  Follow the steps on pages 80, step 15 for fabrication of the verification index, record base and wax occlusion rim, wax try-in and plaster or silicone matrix.

Or

If the clinician and/or laboratory technician would like to use CAD/CAM technology, request a BellaTek Bar. See the BellaTek Bars & Frameworks Manual (ZBINST868).



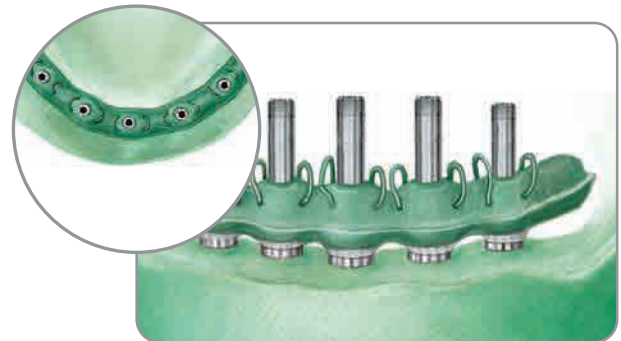

3.  Carefully remove the Low Profile Gold Cylinders or Castable Cylinders from the verification index. Place the cylinders onto the analogs and attach with Low Profile Waxing Screws [LPCWS] using a .048" Large Hex Driver [PHD02N or PHD03N]. Adjust the height of the sleeves as necessary. Wax the hybrid bar pattern to the waxing sleeves and add loops or acrylic retention features to the occlusal surface of the wax pattern. Use the tooth matrix on the cast to position the bar within the confines of the wax denture.



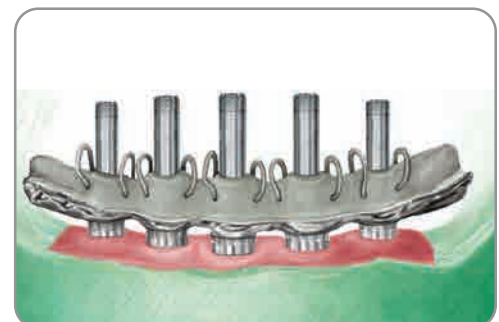

4.  Remove the hybrid bar wax pattern from the cast. Invest, burnout and cast the bar in a low, medium or high noble alloy (see page 14 for casting alloy specifications). Chemically divest, finish and polish the tissue surface of the bar with polishing protectors in place. Return the bar to the restorative dentist for try in and fit verification.

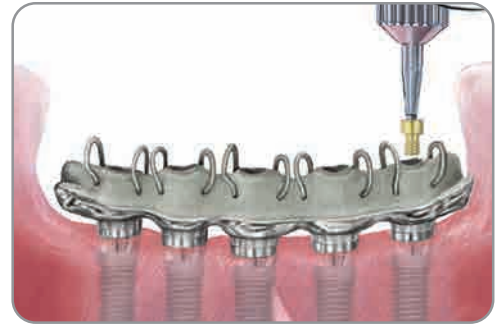

**Restorative Dentist**

5.   Remove the healing caps from the abutments using a .048" Large Hex Driver [PHD02N or PHD03N]. To help prevent accidental swallowing, thread floss through the spinner of the driver. Place the bar onto the abutments. Thread a Low Profile Abutment Gold-Tite Retaining Screw [LPCGSH] into one posterior-most cylinder and finger-tighten using the .048" Large Hex Driver. Visually verify that the bar is completely seated on all of the implants. Remove the screw and place it into the opposite posterior-most cylinder and repeat. If a fit discrepancy is found, cut and index the bar intraorally and return the framework to the laboratory for soldering or welding. Immediately replace the healing caps back onto the abutments.



**Laboratory**

6.   Attach the bar to the Low Profile Analogs with waxing screws using a .048" Large Hex Driver [PHD02N or PHD03N]. Transfer the denture teeth from the matrix onto the bar on the cast and wax the hybrid prosthesis for processing. Flask the waxed prosthesis and boil out. Separate the flask. Opaque the bar in areas where the acrylic resin will be processed to it. Block out all undercuts between the framework and cast with plaster. Process and finish the hybrid prosthesis in a conventional manner. Polishing protectors should be in place during all finishing and polishing procedures.



**NOTE:** A wax/framework try in appointment may be necessary for optimal results.

**Restorative Dentist**

7.   Remove the healing caps from the abutments using a .048" Large Hex Driver [PHD02N or PHD03N]. To help prevent accidental swallowing, thread floss through the spinner of the driver. Place the fixed hybrid prosthesis onto the abutments. Screw the Low Profile Gold-Tite Retaining Screws [LPCGSH] into the Low Profile Abutments and verify fit. Adjust occlusion, remove and polish. Replace the prosthesis and torque the screws to 10 Ncm using a .048" Large Hex Driver Tip [RASH3N or RASH8N] with a torque device [L-TIRW or HTD-C]. Place protective material into the screw access openings. Seal the access openings with acrylic resin. Make any necessary occlusal adjustments. Instruct the patient on maintenance of the prosthesis and oral hygiene.





## Standard Abutment Fixed Hybrid

(See page 74 for considerations and specifications)

### Restorative Dentist

1.  Follow the steps for abutment level impressions on pages 18-20 for the Pick-Up Technique and pages 21-23 for the Twist Lock Transfer Technique.



### Laboratory

2.  Follow the steps on pages 78, step 15 for fabrication of the verification index, record base and wax occlusal rim, wax try-in and plaster or silicone matrix.

Or

If the clinician and/or laboratory technician would like to use CAD/CAM technology, request a BellaTek Bar. See the BellaTek Bars & Frameworks Manual (ZBINST868).



3.  Carefully remove the Standard Abutment Gold Cylinders or Castable Cylinders from the verification index. Place the cylinders onto the analogs and attach with Waxing Screws [WSK10 or WSK15] using a .048" Large Hex Driver [PHD02N or PHD03N]. Adjust the height of the sleeves as necessary. Wax the hybrid bar pattern to the waxing sleeves and add loops or acrylic retention features to the occlusal surface of the wax pattern. Use the tooth matrix on the cast to position the bar within the confines of the wax denture.

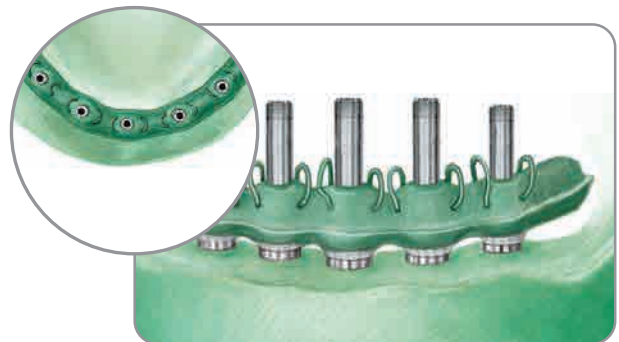

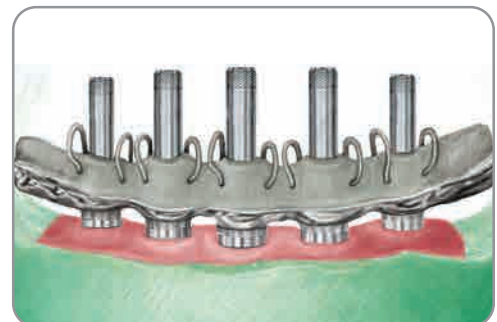

4.  Remove the hybrid bar wax pattern from the cast. Invest, burnout and cast the bar in a low, medium or high noble alloy (see page 14 for casting alloy specifications). Chemically divest, finish and polish the tissue surface of the bar with polishing protectors in place. Return the bar to the restorative dentist for try in and fit verification.





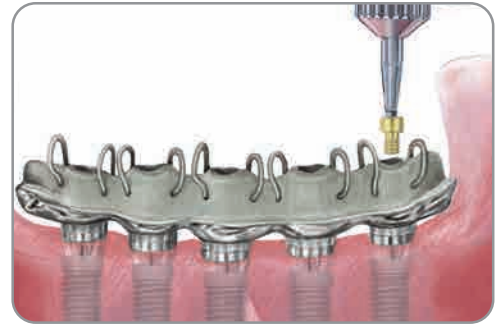

**Restorative Dentist**

5.   Remove the healing caps from the abutments using a .048" Large Hex Driver [PHD02N or PHD03N]. To help prevent accidental swallowing, thread floss through the spinner of the driver. Place the bar onto the abutments. Thread a Hexed Gold-Tite Retaining Screw [GSHx0] into one posterior-most cylinder and finger-tighten using the .048" Large Hex Driver. Visually verify that the bar is completely seated on all of the implants. Remove the screw and place it into the opposite posterior-most cylinder and repeat. If a fit discrepancy is found, cut and index the bar intraorally and return the framework to the laboratory for soldering or welding. Immediately replace the healing caps back onto the abutments.

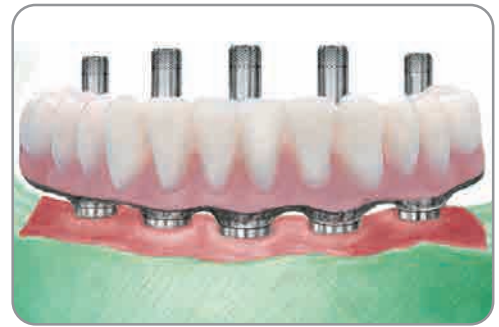

**Laboratory**

6.   Attach the bar to the Standard Abutment Analogs with waxing screws using a Large Hex Driver [PHD02N or PHD03N]. Transfer the denture teeth from the matrix onto the bar on the cast and wax the hybrid prosthesis for processing. Flask the waxed prosthesis and boil out. Separate the flask. Opague the bar in areas where the acrylic resin will be processed to it. Block out all undercuts between the framework and cast with plaster. Process and finish the hybrid prosthesis in a conventional manner. Polishing protectors should be in place during all finishing and polishing procedures.



**NOTE:** A wax/framework try in appointment may be necessary for optimal results.

**Restorative Dentist**

7.   Remove the healing caps from the abutments using a .048" Large Hex Driver [PHD02N or PHD03N]. To help prevent accidental swallowing, thread floss through the spinner of the driver. Place the fixed hybrid prosthesis onto the abutments. Screw the Hexed Gold-Tite Retaining Screws [GSHx0] into the Standard Abutments using the .048" Large Hex Driver and verify fit. Adjust occlusion, remove and polish. Replace the prosthesis and torque the screws to 10 Ncm using a .048" Large Hex Driver Tip [RASH3N or RASH8N] with a torque device [L-TIRW or HTD-C]. Place protective material into the screw access openings. Seal the access openings with acrylic resin. Make any necessary occlusal adjustments. Instruct the patient on maintenance of the prosthesis and oral hygiene.



## UCLA Abutment Fixed Hybrid

(See page 83 for considerations and specifications)

### Restorative Dentist

1.  Follow the steps for abutment level impressions on pages 18-20 for the Pick-Up Technique and pages 21-23 for the Twist Lock Transfer Technique.



### Laboratory

2.  Place the Non-Hexed Gold UCLA Abutments or Castable UCLA Abutments onto the implant analogs. Thread Try-in Screws [MUNITS, ILRGHT or UNITS] or Waxing Screws [IWSU30, WSK10 or WSK15] into the implant analogs and finger-tighten using a .048" Large Hex Driver [PHD02N or PHD03N]. Fabricate a verification index by luting the plastic sleeves together using a low expansion light cure composite resin or autopolymerizing acrylic resin. Also, fabricate a record base and wax occlusion rim.

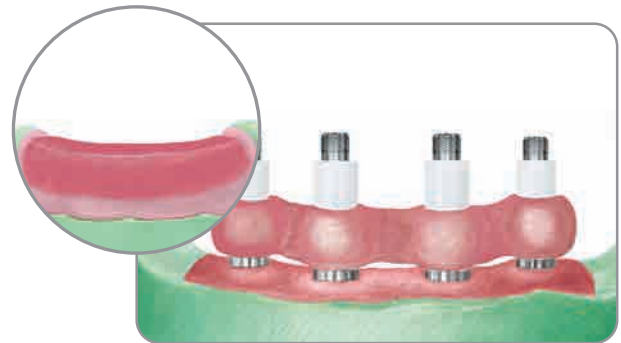

### Restorative Dentist

3.  Remove the healing abutments from the implants using a .048" Large Hex Driver [PHD02N or PHD03N]. To help prevent accidental swallowing, thread floss through the spinner of the driver. Place the occlusion rim in the mouth. Make the interocclusal records. Place the verification index onto the implants. Thread a Try-in Screw [MUNITS, ILRGHT or UNITS] or Waxing Screw [IWSU30 or WSU30] into one posterior-most UCLA Abutment and finger-tighten. Radiograph the interfaces to verify that all cylinders are completely seated on all of the implants. Remove the screw and place it into the opposite posterior-most UCLA Abutment and repeat radiograph. If a fit discrepancy is found, section the index and reassemble intraorally. Remove the index. Immediately replace the healing abutments back onto the implants.

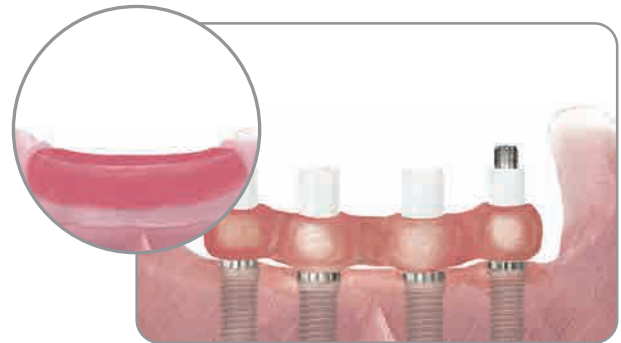

### Laboratory

4.  Verify that the analog positions on the cast are accurate using a verification index. Articulate casts using the interocclusal record. Set the denture teeth on the record base and wax for try in. If the verification index was corrected, the corrected index is used to identify inaccurate analogs in the cast. Take this index back to the cast and identify the inaccurate analog(s). Remove the inaccurate analog(s) from the cast and attach it to the verification index. Re-seat the index on the other remaining analogs into the cast. Verify that the analog does not touch the stone of the cast. Inject a mix of die stone to re-attach the analog to the cast.



Restorative Dentist

5.  Place the wax try-in in the mouth. Verify the occlusion, aesthetics and phonetics. Make any adjustments necessary. If major adjustments are necessary, make a new interocclusal record and return to the laboratory for a new set up and try in.



Laboratory

6.  Make a plaster or silicone matrix of the verified wax try-in and remove the denture teeth inside it. Wax and cast the framework consistent with fixed and removable prosthodontic design parameters.

Or

If the clinician and/or laboratory technician would like to use CAD/CAM technology, request a BellaTek Bar. See the BellaTek Bars & Frameworks Manual (ZBINST868).



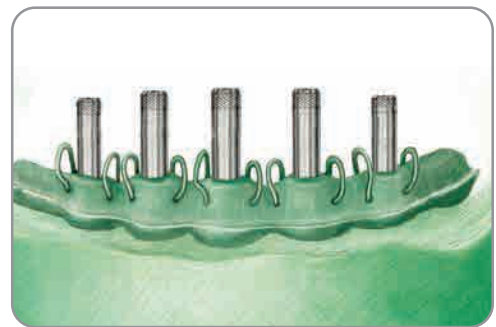

7.  Carefully remove the UCLA Abutments from the verification index. Place the Non-Hexed UCLA Abutments onto the implant analogs. Thread Try-in Screws [MUNITS, ILRGHT or UNITS] or Waxing Screws [IWSU30 or WSU30] into the implant analogs and finger-tighten using a .048" Large Hex Driver [PHD02N or PHD03N]. Adjust the height of the plastic sleeves as necessary. Wax the hybrid bar patterns to the waxing sleeves and add loops or acrylic retention features on the top. Use the matrix on the cast to position the bar within the confines of the wax try-in.

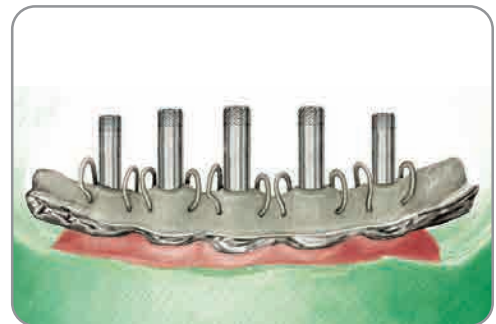

8.  Remove the hybrid bar wax pattern from the cast. Invest, burnout and cast the bar in a low, medium or high noble alloy (see page 14 for casting alloy specifications). Chemically divest, finish and polish the tissue surface of the bar with polishing protectors in place. Return the bar to the restorative dentist for try in and fit verification.





Restorative Dentist

9.   Remove the healing abutments from the implants using a .048" Large Hex Driver [PHD02N or PHD03N]. To help prevent accidental swallowing, thread floss through the spinner of the driver. Place the bar onto the implants. Thread a Try-in Screw [MUNITS, ILRGHT or UNITS] into one posterior-most implant. Radiograph the interfaces to verify that the bar is completely seated on all of the implants. Repeat radiograph after removing the screw and placing it into the opposite posterior-most implant. If a fit discrepancy is found, cut and index the bar intraorally for soldering or welding. Immediately replace the healing abutments back onto the implants.





Laboratory

10.   Attach the bar to the implant analogs with waxing screws using a .048" Large Hex Driver [PHD02N or PHD03N]. Transfer the denture teeth from the matrix onto the bar on the cast and wax the hybrid prosthesis for processing. Flask the waxed prosthesis and boil out. Separate the flask. Opaque the bar in areas where the acrylic resin will be processed to it. Block out all undercuts between the framework and cast with plaster. Process and finish the hybrid prosthesis in a conventional manner. Polishing protectors should be in place during all finishing and polishing procedures.





Restorative Dentist

11.   Remove the healing abutments from the implants using a .048" Large Hex Driver [PHD02N or PHD03N]. To help prevent accidental swallowing, thread floss through the spinner of the driver. Place the Fixed Hybrid prosthesis onto the implants.

 Thread a Certain Gold-Tite Large Hexed Screw [ILRGHG] into the implants using the .048" Large Hex Driver [PHD02N or PHD03N] and finger-tighten.

Or

 Thread a Gold-Tite Square Screw [UNISG] into the implants using a Square Driver [PSQD0N or PSQD1N] and finger-tighten. To help prevent accidental swallowing, thread floss through the spinner of the driver.

  Radiograph the interface to verify an accurate fit. Torque the Certain Gold-Tite Hexed Large Screws to 20 Ncm and Square Gold-Tite Screws to 32-35 Ncm using the proper driver tip with a torque device [L-TIRW or HTD-C]. Place protective material into the screw access openings. Seal the access openings with acrylic resin. Make any necessary occlusal adjustments. Instruct the patient on maintenance of the prosthesis and oral hygiene.



## IOL Abutment Fixed Hybrid

### Considerations:

- Multiple implant bar-retained and fixed removable overdentures
- Multiple-unit porcelain fused to metal restorations
- Minimum interarch space of 9.2 mm
- Minimum tissue height of 2 mm
- Maximum angulation correction of 30°

### Specifications:

- Titanium Alloy

### Instrumentation Needed:

- .048" Large Hex Driver [PHD02N or PHD03N]
- Hexed Gold-Tite Retaining Screw [GSHx0]
- .048" Large Hex Driver Tip [RASH3N or RASH8N]
- Torque Device [L-TIRW or HTD-C]
- .048" Large Hex Driver [PHD02N or PHD03N]

### Restorative Dentist

1.  Follow the steps for abutment level impressions on pages 18-20 for the Pick-Up Technique and pages 21-23 for the Twist Lock Transfer Technique.



### Laboratory

2.  Follow the steps on pages 78, step 15 for fabrication of the verification index, record base and wax occlusion rim, wax try-in and plaster or silicone matrix.

Or

If the clinician and/or laboratory technician would like to use CAD/CAM technology, request a BellaTek Bar. See the BellaTek Bars & Frameworks Manual (ZBINST868).



3.  Carefully remove the IOL Abutment Gold Cylinders or IOL Abutment Castable Cylinders from the verification index. Place the cylinders onto the analogs and attach with IOL Waxing Screws using a .048" Large Hex Driver [PHD02N or PHD03N]. Adjust the height of the sleeves as necessary. Wax the hybrid bar pattern to the waxing sleeves and add loops or acrylic retention features to the occlusal surface of the wax pattern. Use the matrix on the cast to position the bar within the confines of the wax denture.

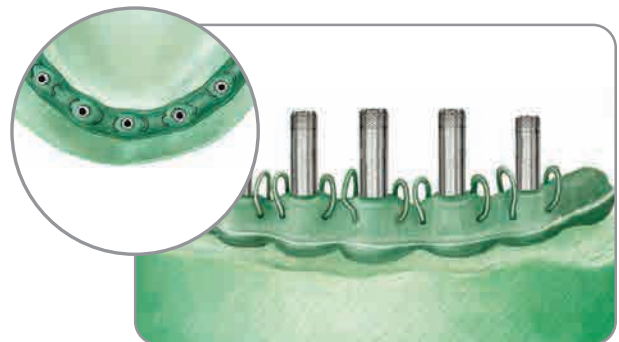



4.  Remove the hybrid bar wax pattern from the cast. Invest, burnout and cast the bar in a low, medium or high noble alloy (see page 14 for casting alloy specifications). Chemically divest, finish and polish the tissue surface of the bar with polishing protectors in place. Return the bar to the restorative dentist for try in and fit verification.

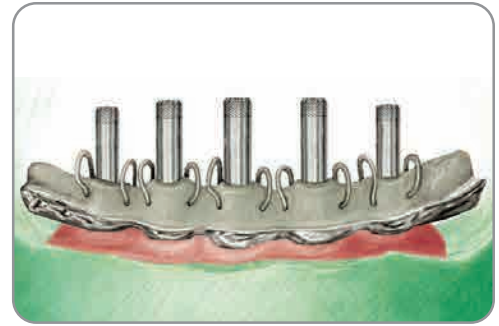

Restorative Dentist

5.  Remove the healing caps from the abutments using a .048" Large Hex Driver [PHD02N or PHD03N]. To help prevent accidental swallowing, thread floss through the spinner of the driver. Place the bar onto the abutments. Thread a Hexed Gold-Tite Retaining Screw [GSHx0] into one posterior-most cylinder and finger-tighten using the .048" Large Hex Driver. Visually verify that the bar is completely seated on all of the implants. Remove the screw and place it into the opposite posterior-most cylinder and repeat. If a fit discrepancy is found, cut and index the bar intraorally and return the framework to the laboratory for soldering or welding. Immediately replace the healing caps back onto the abutments.

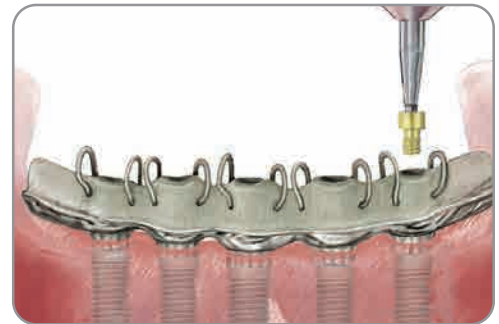

Laboratory

6.  Attach the bar to the analogs with waxing screws using a .048" Large Hex Driver [PHD02N or PHD03N]. Transfer the denture teeth from the matrix onto the bar on the cast and wax the hybrid prosthesis for processing. Flask the waxed prosthesis and boil out. Separate the flask. Opaque the bar in areas where the acrylic resin will be processed to it. Block out all undercuts between the framework and cast with plaster. Process and finish the hybrid prosthesis in a conventional manner. Polishing protectors should be in place during all finishing and polishing procedures.



**NOTE:** A wax/framework try in appointment may be necessary for maximum results.

Restorative Dentist

7.  Remove the healing caps from the abutments using a .048" Large Hex Driver [PHD02N or PHD03N]. To help prevent accidental swallowing, thread floss through the spinner of the driver. Place the fixed hybrid prosthesis onto the abutments. Screw the Hexed Gold-Tite Retaining Screws [GSHx0] into the abutments and verify fit. Adjust occlusion, remove and polish. Replace the prosthesis and torque the screws to 10 Ncm using a .048" Large Hex Driver Tip [RASH3N or RASH8N] with a torque device [L-TIRW or HTD-C]. Place protective material into the screw access openings. Seal the access openings with acrylic resin. Make any necessary occlusal adjustments. Instruct the patient on maintenance of the prosthesis and oral hygiene.



# Tissue-Supported Overdenture

## LOCATOR Abutments

### Considerations:

- Tissue-supported removable overdentures on 2-4 implants
- Partially edentulous overdentures with 1 or more implants
- Limited interarch distance
- Angle correction with up to 40° between divergent implants
- The standard range nylon males only allow for 20° angle correction between divergent implants but the extended range males do allow for 40° between implants

### Specifications:



- **Abutment:** Titanium Alloy With Gold Colored Titanium Nitride Coating
- **Housing:** Titanium Alloy
- **Males:** Nylon

### Instrumentation Needed:

- .048" Large Hex Driver [PHD02N or PHD03N]
- LOCATOR Core Tool/Abutment Driver [LCTDR1]
- .050" Hexed Driver Tip [RASH4 or RASH9]
- Torque Device [L-TIRW or HTD-C]
- LOCATOR Driver Tip [LOADT4 or LOADT9]
- LOCATOR Impression Copings [LAIC1]
- LOCATOR Laboratory Analogs (LALA1)

## LOCATOR Abutment | Indirect Technique

### Surgeon or Restorative Dentist

1.  Select the proper LOCATOR Abutment collar height by measuring the height of the healing abutment above the tissue on the buccal surface, **not** including the domed portion. Subtract this measurement from the total height of the healing abutment and then add 1 mm. The LOCATOR Abutment seating surface should match the implant platform. See pages 15-16 for the Abutment Selection Guide.
2.  Remove the healing abutments from the implants using a .048" Large Hex Driver [PHD02N or PHD03N]. To help prevent accidental swallowing, thread floss through the spinner of the driver.

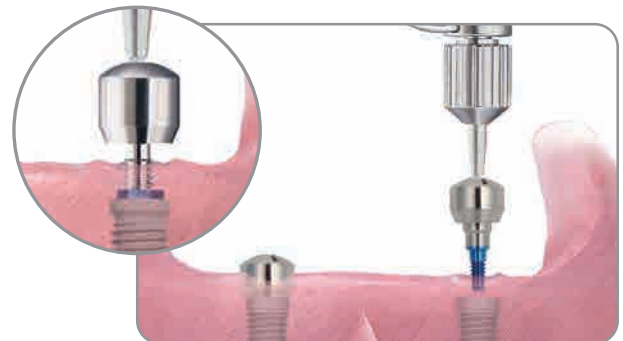



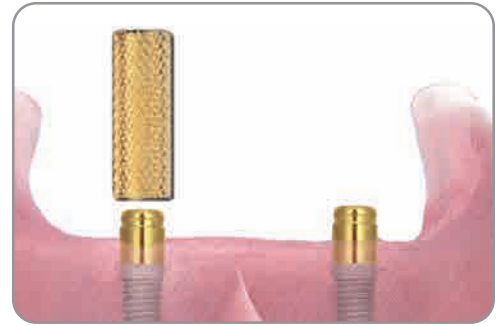

3.  Thread the LOCATOR Abutment into the implant using the plastic delivery tool packaged with the abutment. Use the LOCATOR Core Tool/ Abutment Driver [LCTDR1] and finger-tighten.

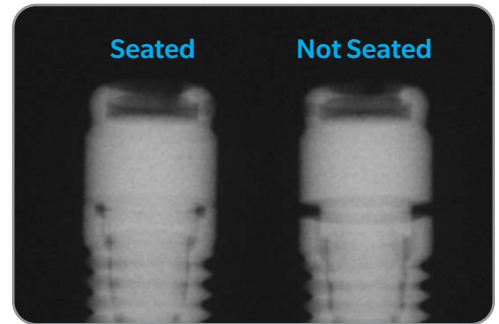

4.  Radiograph the interfaces to verify complete seating of the abutments on all of the implants. Place the film perpendicular to the interface of the abutment on the implant.



5.  Torque the LOCATOR Abutments into the implants to 20 Ncm, using the LOCATOR Core Tool/Abutment Driver [LCTDR1] and a .050 inch Hexed Driver Tip [RASH4 or RASH9] with a torque device [L-TIRW or HTD-C]. If the surgeon places the abutments, the patient's existing denture will be relieved to allow for space around the abutments.

Or

Place the LOCATOR Driver Tip [LOADT4 or LOADT9] into the torque device [L-TIRW or HTD-C] and torque the abutments to 20 Ncm.

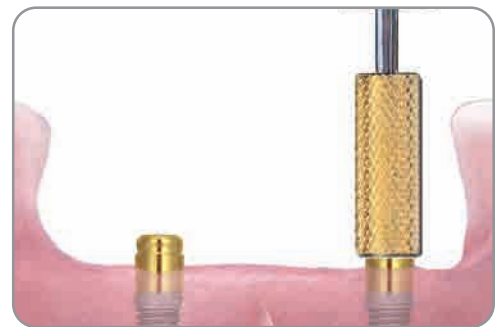

#### Restorative Dentist

6.  A custom or stock closed top impression tray may be used. Provide relief for the height of the LOCATOR Abutments and impression copings plus 2 mm. The impression copings are 4.5 mm in height.

**NOTE:** If the impression is to be used to fabricate the overdenture, a custom impression tray should be made.



7.  Place the LOCATOR Impression Copings [LAIC1] on the abutments and verify complete seating. Syringe light viscosity impression material around the impression copings. Use medium or heavy viscosity impression material for the tray.

**NOTE:** Sometimes it is helpful to place impression adhesive on the impression copings to ensure their removal in the impression.

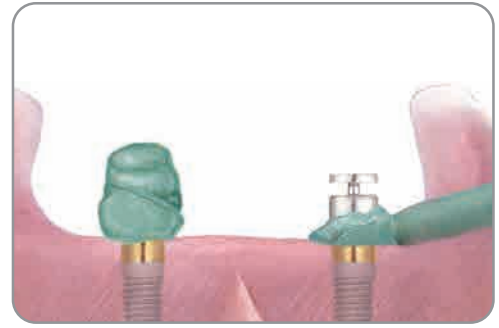

8.  Load the impression tray and seat it in the mouth. Allow the impression material to set per the manufacturer's instructions.



9.  Remove the impression from the mouth and verify that the impression material completely adapted around each impression coping. The impression copings should remain inside the impression. Relieve the patient's existing denture to allow for the LOCATOR Abutments. Place a chairside soft liner into the denture where space has been made and then seat the denture. Have the patient close lightly into centric occlusion. Allow the soft liner to set per the manufacturer's instructions.



#### Laboratory

10.  Insert the LOCATOR Laboratory Analogs (LALA1) into the impression copings using firm pressure until fully engaged.



11.  Pour the cast in die stone, being careful to not dislodge the analogs. Fabricate a record base and wax occlusion rim.

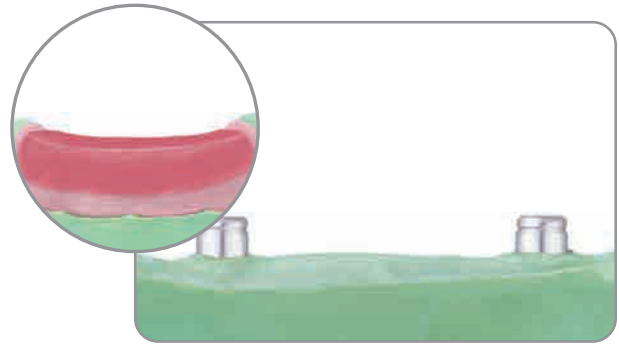

Restorative Dentist

12.  Place the occlusion rim in the mouth. Make the interocclusal records.

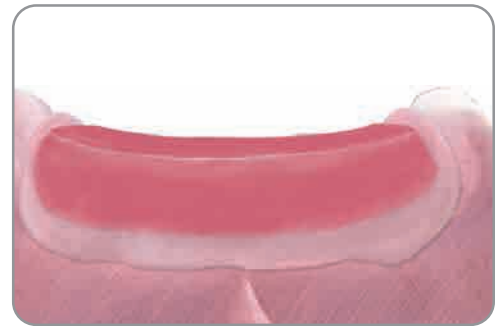

Laboratory

13.  Articulate casts using the interocclusal record. Set the denture teeth on the record base for the wax try-in.



Restorative Dentist

14.  Place the wax denture in the mouth. Verify occlusion, aesthetics and phonetics. Make any adjustments necessary. If major adjustments are necessary, make a new interocclusal record and return it to the laboratory for a new articulator mounting, wax denture set-up and try in.



Laboratory

15.  After the wax try-in is verified, flask the denture on the cast. Boil out the wax and separate the flask. Place the LOCATOR White Spacer Rings over the analogs to prevent acrylic resin from flowing under the housings. Place the Housing/Black Processing Male Attachment assembly onto the analogs.

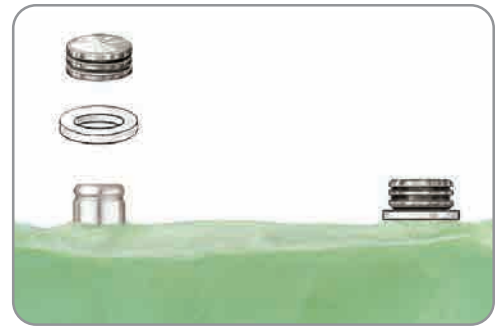

16.  Process and finish the denture with the LOCATOR Housings in place following conventional procedures. Remove the Black Processing Males and replace with Final Male Attachments (see step 17).



Restorative Dentist

17.  Remove the Black Processing Male by placing the Removal Tip end of the LOCATOR Core Tool/Abutment Driver [LCTDR 1] into the Housing/Black Processing Male assembly and turning the handle three rotations counter-clockwise. Place the Final Male Attachment on the attachment insertion end of the Core Tool and press it firmly into the housing. The attachment retention on the abutment may be reduced by placing the pink Light Retention Male or the blue Extra Light Retention Male rather than the clear Final Male. The male attachments are replaced after normal wear by inserting the Removal Tip straight into the bottom of the nylon male. Tilt the tool so the sharp edge will grab hold of the male and pull it out of the cap.

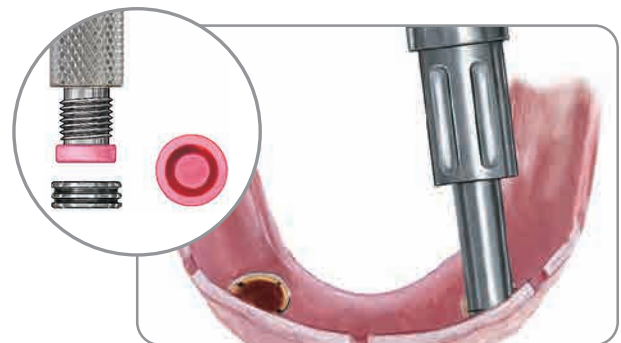

Male Attachments:



1 lb. of retention [LAELM]



3 lb. of retention [LLRMS]



5 lb. of retention [LARMS]



18.  Place the overdenture onto the LOCATOR Abutments in the mouth, engaging the attachments. Make any necessary occlusal or tissue adjustments. Instruct the patient on insertion, removal, maintenance of the prosthesis and oral hygiene.





## LOCATOR Abutment | Direct Technique

(See page 96 for considerations and specifications)



### Restorative Dentist

1.   Follow steps 1-5 on pages 94-95 for LOCATOR Abutment Indirect Technique selection and placement.



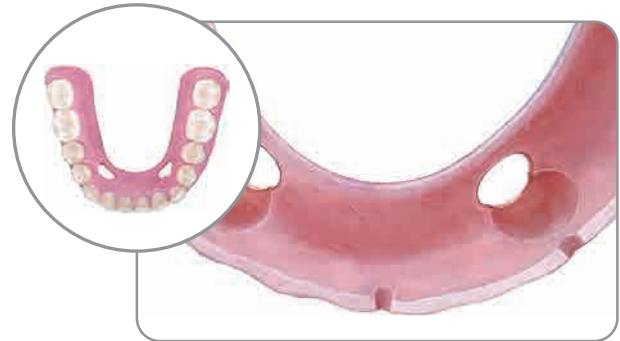

2.   A direct chairside processing technique may be used for a patient's existing denture or a new denture by cutting relief and lingual vent windows in the acrylic resin denture base over the abutment areas.

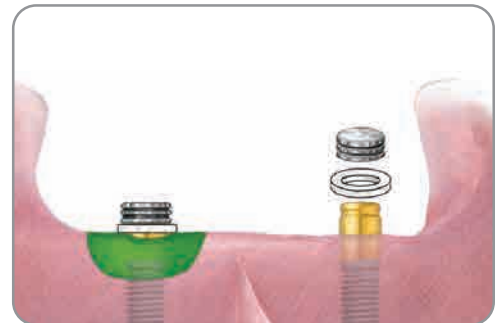

3.   Cut two small pieces of rubber dam and place a hole in the center of each. Place these over the abutments to protect the tissue. Place the White Spacer Rings over the LOCATOR Abutments to prevent acrylic resin from flowing into undercuts around the housings. Place the Housing/Black Processing Male Attachment assembly onto the LOCATOR Abutments in the mouth. Try in the denture over the housings to verify that it is completely seated on the ridge and the housings are not in contact with the denture. Eliminate all contacts between the LOCATOR Abutments and denture base.



4.   Place autopolymerizing acrylic resin or light cure composite resin over the LOCATOR Housings and into relief areas of the denture. Place and position the denture in the mouth and have the patient close lightly into centric occlusion. Allow the acrylic resin to set per the manufacturer's instructions.



5.  Remove the Black Processing Male by placing the Removal Tip end of the LOCATOR Core Tool/Abutment Driver [LCTDR1] into the Housing/Black Processing Male assembly and turning the handle three rotations counter clockwise. Place the Final Male Attachment on the attachment insertion end of the Core Tool and press it firmly into the housing. The attachment retention on the abutment may be reduced by placing the pink Light Retention Male or the blue Extra Light Retention Male rather than the clear Final Male. The male attachments are replaced after normal wear by inserting the Removal Tip straight into the bottom of the nylon male. Tilt the tool so the sharp edge will grab hold of the male and pull it out of the cap.

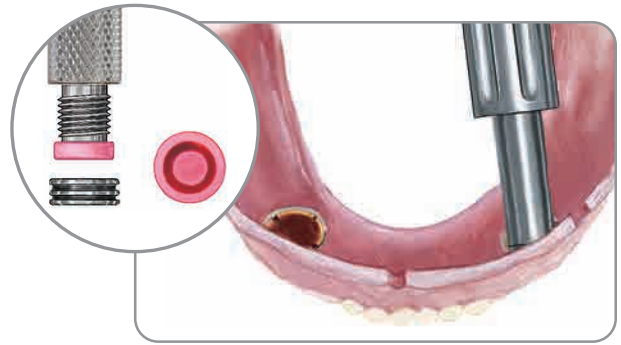

Male Attachments:



1 lb. of retention [LAELM]



3 lb. of retention [LLRMS]



5 lb. of retention [LARMS]

6.  Remove the denture, fill any voids with a new mix of acrylic or composite resin around the housings and polish. Remove the Black Processing Males and replace these with the Final Male Attachments (see step 5). Place the overdenture onto the LOCATOR Abutments in the mouth, engaging the attachments. Make any necessary occlusal or tissue adjustments. Instruct the patient on insertion, removal, maintenance of the prosthesis and oral hygiene.









Contact us at 1-800-266-9920 or visit  
[zimmerbiometdental.com](http://zimmerbiometdental.com)

Zimmer Biomet Dental  
Global Headquarters  
4555 Riverside Drive  
Palm Beach Gardens, FL 33410  
Tel: +1-561-776-6700  
Fax: +1-561-776-1272

ZB Dental India Pvt. Ltd.  
904/905, A-Wing, Damji Shamji Corporate Square,  
Pant Nagar, Ghatkopar East,  
Mumbai – 400075 (INDIA)  
Tel.: +91-22-6901-3700  
Email: [customercare.indiadental@zimmerbiomet.com](mailto:customercare.indiadental@zimmerbiomet.com)

Zimmer Biomet does not practice medicine. The operative techniques were developed in conjunction with health care professionals. Each surgeon should exercise his or her own independent judgment in the diagnosis and treatment of an individual patient, and this information does not purport to replace the comprehensive training surgeons have received. As with all surgical procedures, the technique used in each case will depend on the surgeon's medical judgment as the best treatment for each patient. Results will vary based on health, weight, activity and other variables. Not all patients are candidates for this product and/or procedure.

Unless otherwise indicated, as referenced herein, all trademarks are the property of Zimmer Biomet; and all products are manufactured by one or more of the dental subsidiaries of Zimmer Biomet Holdings, Inc. and marketed and distributed by Zimmer Biomet Dental and its authorized marketing partners. For additional product information, please refer to the individual product labeling or instructions for use. Product clearance and availability may be limited to certain countries/regions. This material is intended for clinicians only and does not comprise medical advice or recommendations. Distribution to any other recipient is prohibited. This material may not be copied or reprinted without the express written consent of Zimmer Biomet Dental. ZBINSTRMIN\_EN REV A 03/21 ©2021 Zimmer Biomet. All rights reserved.

