

Eztetic® 3.1 mmD Implant System

Product Catalog and Surgical Technique

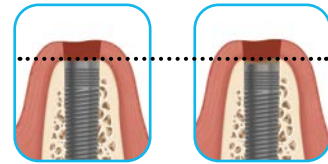

Table of Contents



Overview	1
• General Information	1

Implant Design And Specifications	3
• Implant Platform	3
• Implant Connection	3
• Implant Platform	4
• Implant Placement Guidelines	4
• Indications For Use	4



Eztetic Implants	5
• Implants	5



Eztetic Prosthetics (NP Platform)	6
• Healing Collars	6
• Impression Transfer Components	6
• Provisional Restoration Components	6
• Cement-Retained Components	6
• "Cast To" Gold Abutment Components	7
• Overdenture Attachments	7
• Prosthetic Accessories And Tools	8



Eztetic Instrumentation	9
• Surgical Kit	9
• NP Surgical Module	10
• Color Coding	11
• NP Surgical Module Ordering Information	11
• Replacement Instrumentation Ordering Information	11



Surgical Technique	12
• Drilling Sequence Guidelines	12
• Surgical Procedure	13



References	16
-------------------	-----------

Overview

General Information

The 3.1 mmD Eztetic Implant offers a narrow, powerful solution for demanding anterior spaces. This innovative implant is designed to provide initial stability¹, allowing immediate restorations when clinically appropriate. The conical, Double Friction-Fit™ Connection with platform switch, combined with narrow platform (NP) prosthetics, are designed for crestal bone maintenance² and good aesthetics by accommodating maximum soft-tissue volume. The NP Surgical Module conveniently snaps into the Tapered Screw-Vent® Surgical Kit for streamlined surgical procedures.

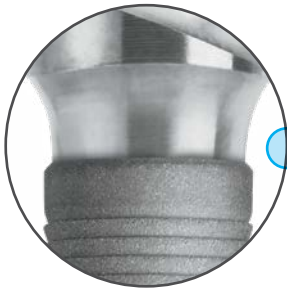

Restorative Profile For Aesthetic Emergence:

Implant-abutment connection along with a contour abutment profile are designed to provide space for soft-tissue and aesthetic emergence of the restoration

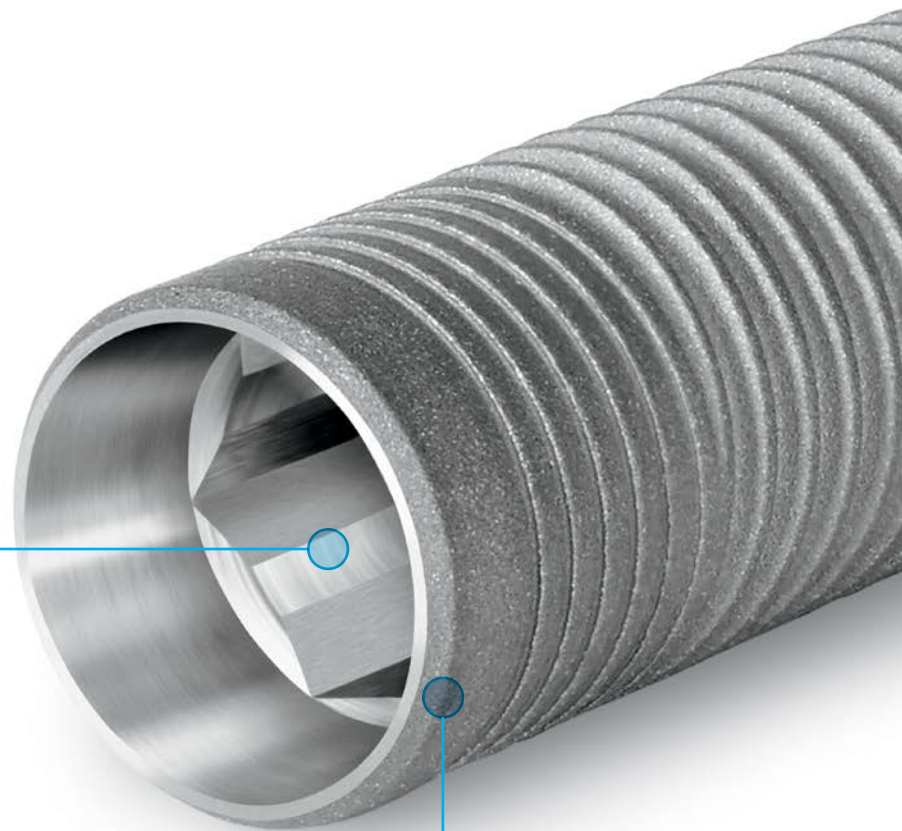

Strength³ For Long-Lasting Aesthetics

Implant design and a conical Double Friction-Fit Connection are combined for exceptional strength, reduced micromovement and microleakage

Primary Stability¹ For Immediate Aesthetics

Tapered implant geometry combined with dedicated soft- and dense-bone surgical protocols are designed for high primary stability in all types of bone

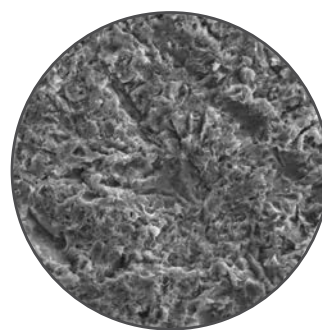
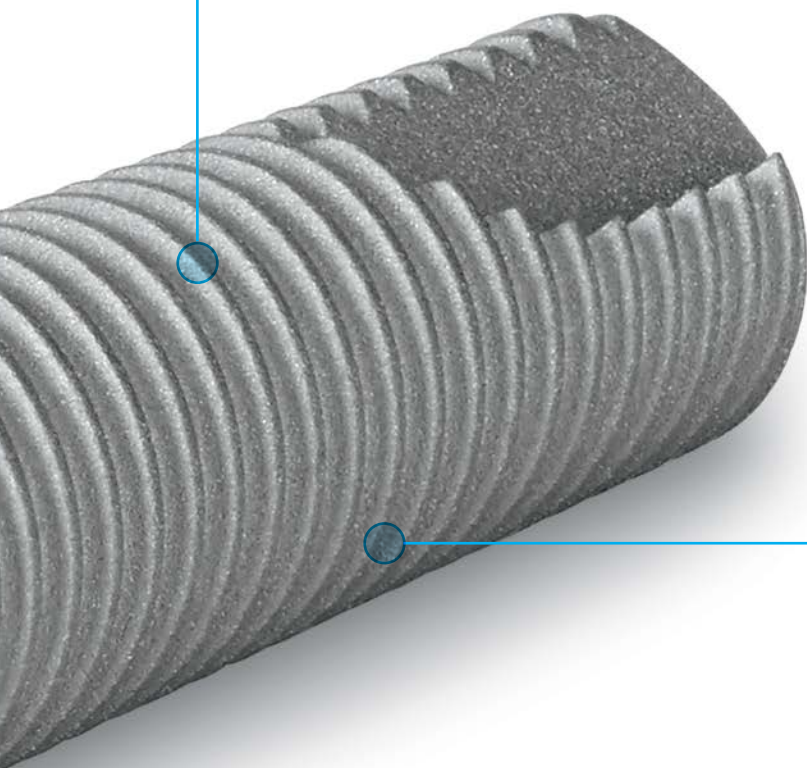

MTX[®] Microtexture
At 2000x Magnification

MTX Surface For Increased Bone Apposition^{3,4}

The MTX Microtextured Surface has been documented to achieve high levels of bone-to-implant contact and successful clinical results under conditions of immediate loading

Coronal Options For Bone Level Maintenance

The coronal microgrooves are designed to preserve crestal bone.⁵

Two coronal surface configurations are available:

- Full MTX Microtexturing with MTX Crestal Microgrooves (Model CT)
- 0.5 mm Machined Collar with MTX Crestal Microgrooves (Model CM)

Implant Design and Specifications

Eztetic Dental Implant - Fully Textured With Microgrooves And 0.5 mm Machined Collar With Microgrooves

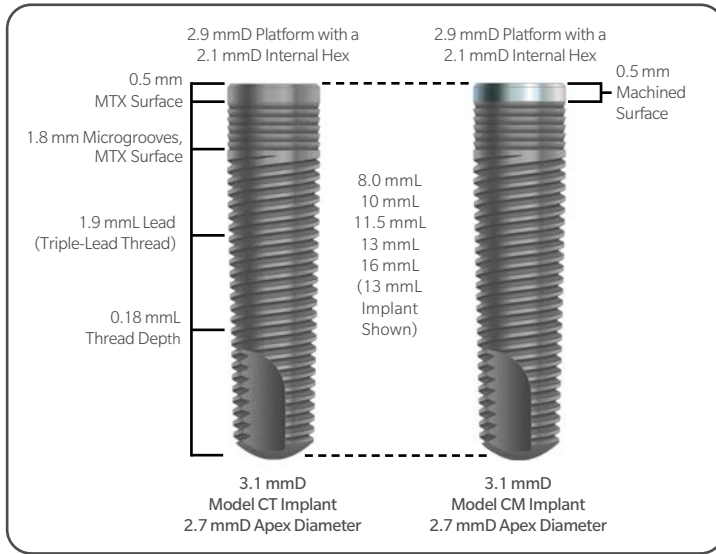

The 3.1 mmD Eztetic Dental Implants have a MTX microtextured or 0.5 mm machined coronal aspect, followed by 1.8 mm of the MTX Surface with microgrooves. The six microgrooves are circumferential with a depth of 0.06 mm and peak-to-peak width of 0.3 mm. Triple-lead threads begin immediately after the microgrooves and continue to the apex. The degree of body taper varies between 1° and 4°, depending on implant length.

Conical, Double Friction-Fit Technology

The 3.1 mmD Eztetic Implants feature a conical Double Friction-Fit Connection designed to reduce micromovement and microleakage via a precise implant-abutment interface, aiding in crestal bone maintenance.

Figure 1A The implant-abutment connection offset along with a Contour Abutment are designed to provide space for soft-tissue and aesthetic emergence of the restoration.

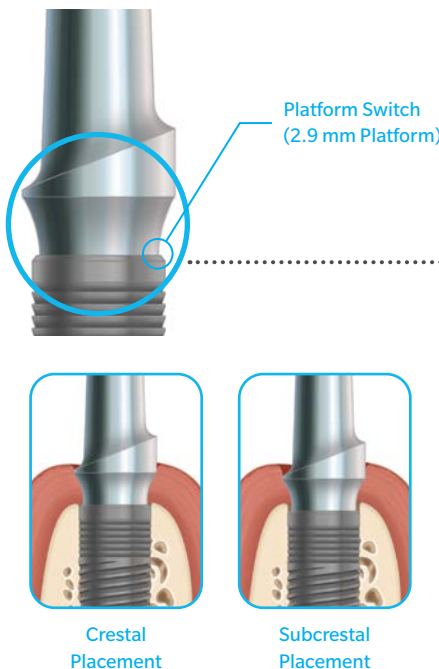
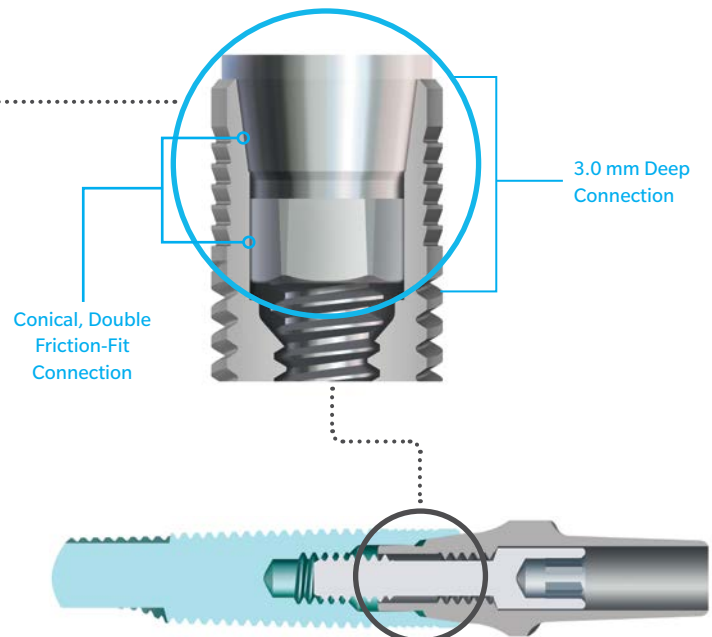
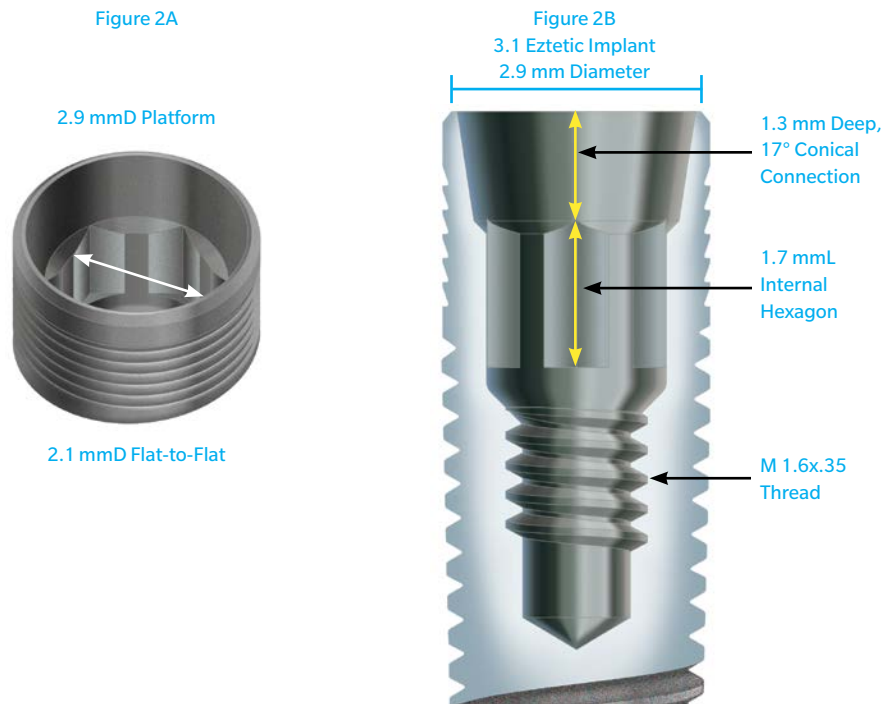

Figure 1B The 3.1 mmD Eztetic Implants feature a conical Double Friction-Fit Connection designed to reduce micromovement and microleakage via a precise implant-abutment interface, aiding in crestal bone maintenance.



Implant Platform

The implant platform diameter is measured across the most coronal part of the implant. The 3.1 mmD Eztetic Implant features a 2.9 mmD prosthetic platform. A 1.3 mm deep, 17° internal cone extends from the outermost diameter (2.9 mmD) of the implant platform to the internal hex of the implant. The internal hex is 2.1 mm flat-to-flat with a depth of 1.7 mm (Fig. 2A and 2B). The 3.0 mm deep conical connection is designed to distribute stresses deep into the implant and away from the crestal bone to aid in crestal bone maintenance.



Implant Placement Guidelines

For Pre-Surgical Planning Instructions and Anatomical Criteria guidelines please refer to the Tapered Screw-Vent Surgical Manual.

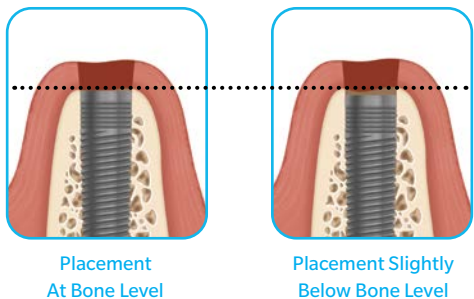

Collar Depth Adjustment

The 3.1 mmD Eztetic Dental Implants are designed to be placed at bone level or slightly below bone level, according to clinical preference and patient anatomy.

Indications For Use

The 3.1 mmD Eztetic Dental Implants are designed for use in the anterior maxilla or mandible for immediate loading or for loading after a conventional healing period. Implants may be used to replace one or more missing teeth. Immediate loading is indicated when there is good primary stability and an appropriate occlusal load.

The 3.1 mmD Eztetic Dental Implants may be placed immediately following an extraction or loss of natural teeth provided there is sufficient volume of alveolar bone to minimally support the implant (minimum 1.0 mm circumferential and 2.0 mm apical).

The 3.1 mmD Eztetic Dental Implants should be splinted to additional implants when used in the pre-molar region and should not be used in the molar region. For more information, please review the full instructions for use.

Eztetic Implant System

Implants

Implant Platform Color-Coding

3.1 mmD Eztetic Implants are available with a 2.9 mmD prosthetic platform.

Implant Diameter	Implant Platform	Color-Coding
3.1 mmD	NP (2.9 mmD)	● Light Blue

NP = Narrow Platform

Abutment Emergence Profile Compatibility

Abutment Emergence Profile*	Color-Coding
4.5 mmD	● Tan

*For Contour components.

NOTE: Contour Abutments with 3.7 mmD Emergence Profile are not compatible with 3.5 mmD Contour Restorative Components.

Eztetic Dental Implants, MTX Surface, Fully Textured With Microgrooves

Includes Healing Screw (CCSNP)



Catalog Numbers						
Implant Diameter	Implant Platform	8.0 mmL	10 mmL	11.5 mmL	13 mmL	16 mmL
3.1 mmD	● NP (2.9 mmD)	CT318	CT3110	CT3111	CT3113	CT3116

Eztetic Dental Implants, MTX Surface, 0.5 mm Machined Collar With Microgrooves

Includes Healing Screw (CCSNP)



Catalog Numbers						
Implant Diameter	Implant Platform	8.0 mmL	10 mmL	11.5 mmL	13 mmL	16 mmL
3.1 mmD	● NP (2.9 mmD)	CM318	CM3110	CM3111	CM3113	CM3116

Implant Fatigue Strength¹

The 3.1 mmD Eztetic Implants achieved 43% higher fatigue strength compared to selected competitive implants of similar diameters.¹

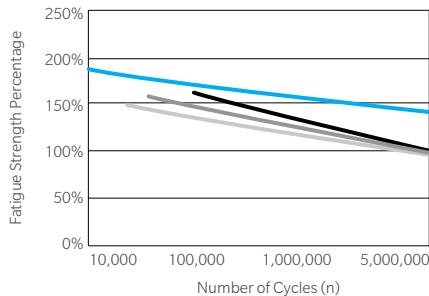

■ Eztetic 3.1 mmD Implant ■ Competitor 1 3.0 mmD Tapered Internal Implant ■ Competitor 2 3.0 mmD Implant ■ Competitor 3 3.0 mmD Implant

All Products were tested in increments of 5.

Insertion Torque¹

The 3.1 mmD Eztetic Implants achieved high insertion torque.¹

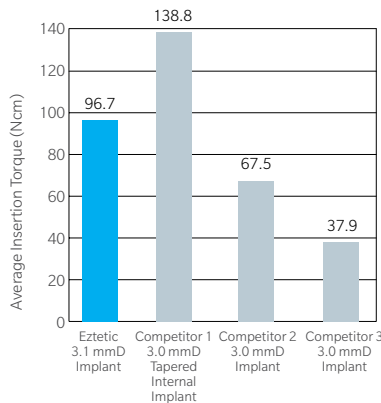

Benchtop engineering test utilizing a dense bone substrate.¹

Torsional Yield Strength¹

The 3.1 mmD Eztetic Implant interface withstood higher torsional forces than the selected competitors.¹

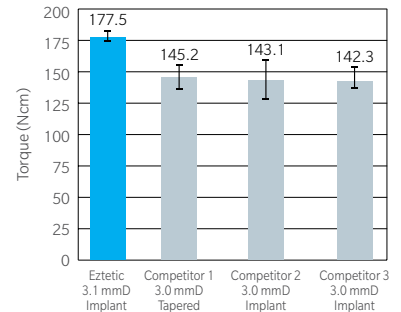

Benchtop engineering test utilizing the implants and their corresponding drivers.¹

Eztetic Implant System

Prosthetics (NP Platform)

Surgical Healing Screw, Replacement



Catalog Numbers	
Implant Platform	Catalog No.
● NP (2.9 mmD)	CCSNP

Healing Collars



Catalog Numbers				
Implant Platform	Emergence Profile	Cuff Height		
		1.5 mm	3.0 mm	4.5 mm
● NP (2.9 mmD)	3.7 mmD	CHCNP31	CHCNP33	CHCNP34
● NP (2.9 mmD)	4.5 mmD	CHCNP41	CHCNP43	CHCNP44

Indirect Transfers (Closed-Tray Procedure) Color-coded by implant platform.

Includes a Retaining Screw (CASLT)



Catalog Numbers				
Implant Platform	Emergence Profile	Cuff Height		
		1.5 mm	3.0 mm	4.5 mm
● NP (2.9 mmD)	3.7 mmD	CITNP31	CITNP33	CITNP34
● NP (2.9 mmD)	4.5 mmD	CITNP41	CITNP43	CITNP44
Replacement Retaining Screw		CASLT	CASLT	CASLT

Direct Transfers (Open-Tray Procedure) Color-coded by implant platform.

Includes a Retaining Screw (CASLC)



Catalog Numbers				
Implant Platform	Emergence Profile	Cuff Height		
		1.5 mm	3.0 mm	4.5 mm
● NP (2.9 mmD)	3.7 mmD	CDTNP31	CDTNP33	CDTNP34
● NP (2.9 mmD)	4.5 mmD	CDTNP41	CDTNP43	CDTNP44
Replacement Retaining Screw		CASLC	CASLC	CASLC

Implant Analog, Titanium Color-coded by implant platform.



Catalog Numbers	
Implant Platform	Catalog No.
● NP (2.9 mmD)	CIANP

Figure A



NP Platform

Figure B

The top surface of the healing collar is etched with three symbols to reference implant platform diameter (left), emergence profile diameter (top right) and cuff height (lower right). In some cases, only the initial digit of the measurement is shown. See item number table above for specific measurements. NP = Narrow Platform (2.9 mmD)



Eztetic Prosthetics (NP Platform)

Titanium Temporary Abutment

Includes a Retaining Screw (CUAS) and a Long Processing Screw (CASLC)



Catalog Numbers		
Implant Platform	Emergence Profile	Catalog No.
● NP (2.9 mmD)	3.5 mmD	CTANP31
Replacement Retaining Screw		CUAS
Replacement Long Processing Screw		CASLC

Contour Abutments, Straight

Includes a Retaining Screw (CUAS)



Catalog Numbers				
Implant Platform	Emergence Profile	Cuff Height		
		1.5 mm	3.0 mm	4.5 mm
● NP (2.9 mmD)	● 3.7 mmD*	CANP31S	CANP33S	CANP34S
● NP (2.9 mmD)	● 4.5 mmD**	CANP41S	CANP43S	CANP44S
Replacement Retaining Screw		CUAS	CUAS	CUAS

* Contour Abutments with 3.7 mmD Emergence Profile are not compatible with 3.5 mmD Contour Restorative Components.

** Please refer to the Tapered Screw-Vent Implant System catalog for a list of 4.5 mmD Contour Restorative Components available to facilitate restoration of Contour Abutments with 4.5 mmD Emergence Profile.

Angled Abutments, 20°

Includes a Retaining Screw (CUAS)



Catalog Numbers		
Implant Platform	Emergence Profile	Catalog No.
● NP (2.9 mmD)	3.5 mmD	C20A3
Replacement Retaining Screw		CUAS

"Cast To" Gold Abutments, Engaging

Includes a Retaining screw (CUAS)



Catalog Numbers		
Implant Platform	Emergence Profile	Catalog No.
● NP (2.9 mmD)	3.5 mmD	CEANP31
Replacement Retaining Screw		CUAS
Long Processing Screw		CASLC

Contour Abutments, Angled 17°

Includes a Retaining Screw (CUASA or CUAS).



Catalog Numbers			
Implant Platform	Emergence Profile	Cuff Height	
		1.5 mm	3.0 mm
● NP (2.9 mmD)	3.7 mmD*	CANP31A	CANP33A
● NP (2.9 mmD)	4.5 mmD*	CANP41A	CANP43A
Replacement Retaining Screw		CUASA	CUAS

* Contour Abutments with 3.7 mmD Emergence Profile are not compatible with 3.5 mmD Contour Restorative Components.

** Please refer to the Tapered Screw-Vent Implant System catalog for a list of 4.5 mmD Contour Restorative Components available to facilitate restoration of Contour Abutments with 4.5 mmD Emergence Profile.

Locator® Abutments



Catalog Numbers						
Implant Platform	Cuff Height					
	1.0 mm	2.0 mm	3.0 mm	4.0 mm	5.0 mm	6.0 mm
● NP (2.9 mmD)	CLOCNP1	CLOCNP2	CLOCNP3	CLOCNP4	CLOCNP5	CLOCNP6

Locator Attachment Components Compatible with the existing Locator Components. Please refer to the Tapered Screw-Vent Catalog for additional options.



Catalog Numbers		
Description	Qty.	Catalog No.
Male Processing Package, Includes 2 Each of Metal Housings with Black Processing Males, Block-Out Spacers, Clear, Pink and Blue Replacement Males	2 Ea.	LOCMP2
Male Processing Package, Includes 10 Each of Parts Listed Above	10 Ea.	LOCMP10

Ball Abutment Abutments do not engage internal hex connection. Cap Attachment Housing and Nylon Liner are sold separately (CA).











Catalog Numbers			
Implant Platform	Cuff Height		
	2.0 mm	4.0 mm	6.0 mm
● NP (2.9 mmD)	CBANP2	CBANP4	CBANP6

Overdenture Components Compatible with the existing Overdenture Components. Please refer to the Tapered Screw-Vent Catalog for additional options.



Catalog Numbers	
Description	Catalog No.
Cap Attachment Housing (CAH)/Cap Attachment Nylon Liner (CAN)	CA
Cap Attachment Housing	CAH
Cap Attachment Nylon Liner (Transparent)	CAN
Cap Attachment Nylon Liner (Gray – Rigid Retention)	CAN-G

Prosthetic Tools

Catalog Numbers	
Description	Catalog No.
 Hex Driver, Short, with GemLock® Retention (1.25 mm, 22 mmL)	HXGR1.25
 Hex Driver, Long, with GemLock Retention (1.25 mm, 30 mmL)	HXLGR1.25
 Latch-Lock Hex Driver (Short) for Surgical and Prosthetic Screws (may require Reduction Handpiece) (1.25 mm, 23 mmL)	HX1.25D
 Latch-Lock Hex-Driver (Long) for Surgical and Prosthetic Screws (may require Reduction Handpiece) (1.25 mm, 26 mmL)	HXL1.25D
 Torque Wrench, Restorative (adjustable torque range 10 Ncm – 35 Ncm)	TWR
 Torque Wrench Hex Driver, Short (1.25 mm, 17 mmL)	TW1.25
 Torque Wrench Hex Driver, Long (1.25 mm, 22 mmL)	TW1.25L
 Removal Tool for Eztetic Abutments (NEW)	CLRT2

NOTE: CLRT2 is included with the NP Surgical Module.

Eztetic Instrumentation

Tapered Screw-Vent Surgical Kit

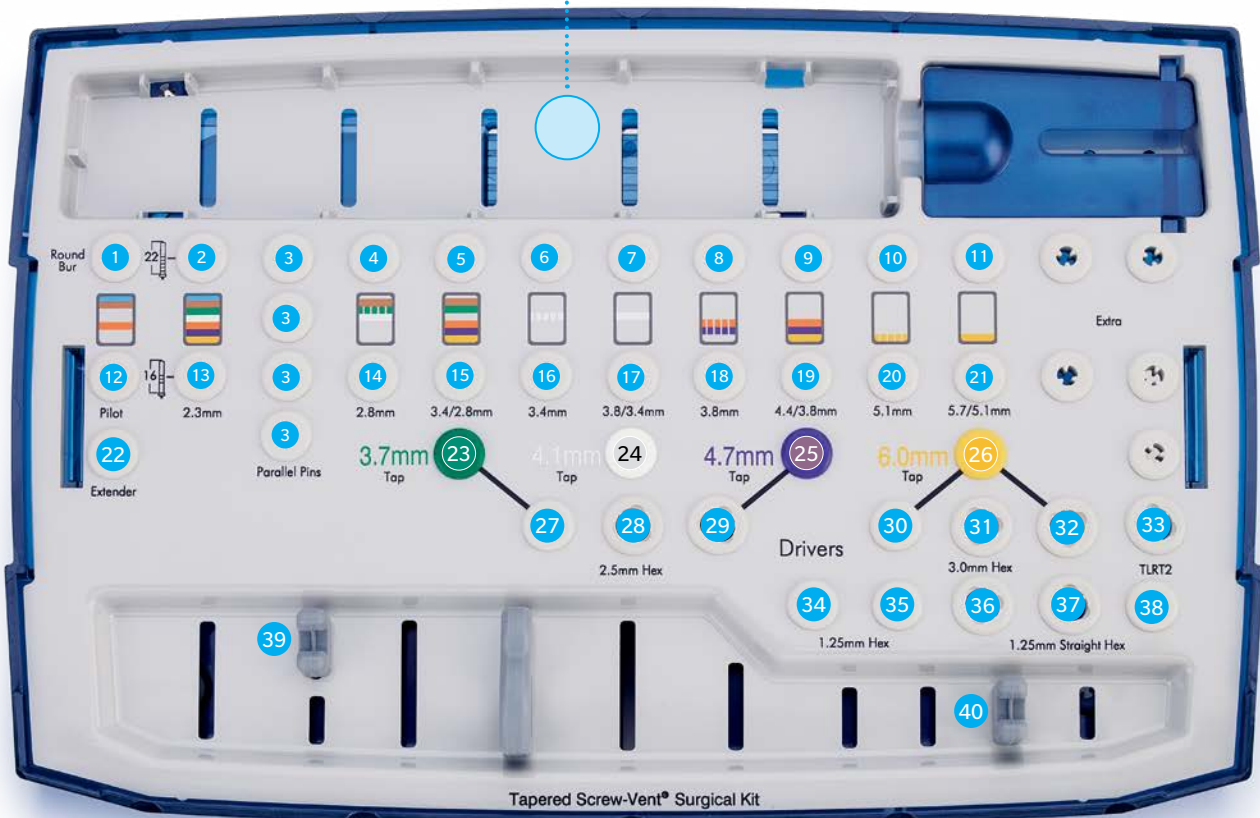
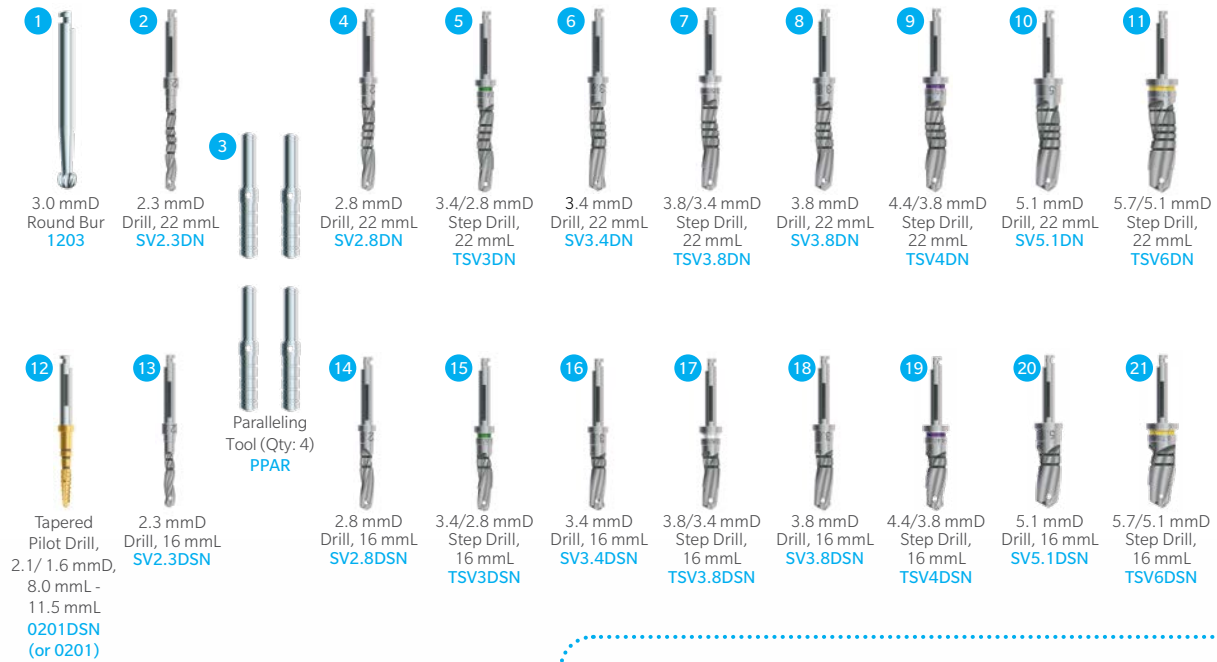

NP Surgical Module



The NP Surgical Module snaps into the Tapered Screw-Vent Surgical Kit



For maximum cutting efficiency, replace drills frequently.

Color Coding

Implant diameter	3.1 mmD
Surgical sequence color bar	
Drill band color for dense bone protocol	
Implant cap color and restorative platform	 2.9 mmD
Vial cap label NP: Narrow Platform (2.9 mmD)	

NP Surgical Module



Catalog Numbers		
Description	Qty.	Catalog No.
NP Surgical Module (To be inserted into the TSVKIT). Includes:	1 Ea.	NPMOD
NP Surgical Module (Tray Only)		NPTRAY
2.4 mmD Driva Surgical Drill, 22 mmL		SV2.4DN
2.8/2.4 mmD Driva Surgical Step Drill, 22 mmL		ZOP28DN
3.0 mmD Cortical Bone Tap Tool		ZOPTT30
2.1 mm GemLock Hex Drill, Latch Lock, Short		CHD2.1
2.1 mm GemLock Hex Drill, Latch Lock, Long		CHDL2.1
2.1 mm GemLock Hex Tool, Ratchet, Short		CHR2.1
2.1 mm GemLock Hex Tool, Ratchet, Long		CHRL2.1
Removal Tool for Eztetic Abutments		CLRT2

Please refer to the Tapered Screw-Vent Implant System Catalog for a complete list of surgical instrumentation in the Zimmer® Instrument Kit System.

Replacement Surgical Instrumentation



Catalog Numbers	
Description	Catalog No.
2.4 mmD Driva Surgical Drill, 22 mmL	SV2.4DN
2.8/2.4 mmD Driva Surgical Step Drill, 22 mmL	ZOP28DN
3.0 mmD Cortical Bone Tap Tool	ZOPTT30
2.1 mm GemLock Hex Drill, Latch Lock, Short	CHD2.1
2.1 mm GemLock Hex Drill, Latch Lock, Long	CHDL2.1
2.1 mm GemLock Hex Tool, Ratchet	CHR2.1
2.1 mm GemLock Hex Tool, Ratchet	CHRL2.1
Removal Tool for Eztetic Abutments	CLRT2

Surgical Technique

Prosthetics (NP Platform)

Drilling Sequence Guidelines

Soft bone protocol: follow solid color bars on the surgical tray surface until the segmented color bar. The segmented color bar indicates the final drill for soft bone protocol.

Dense bone protocol: follow solid color bars only. The last solid bar in the sequence represents the final drill for dense bone.

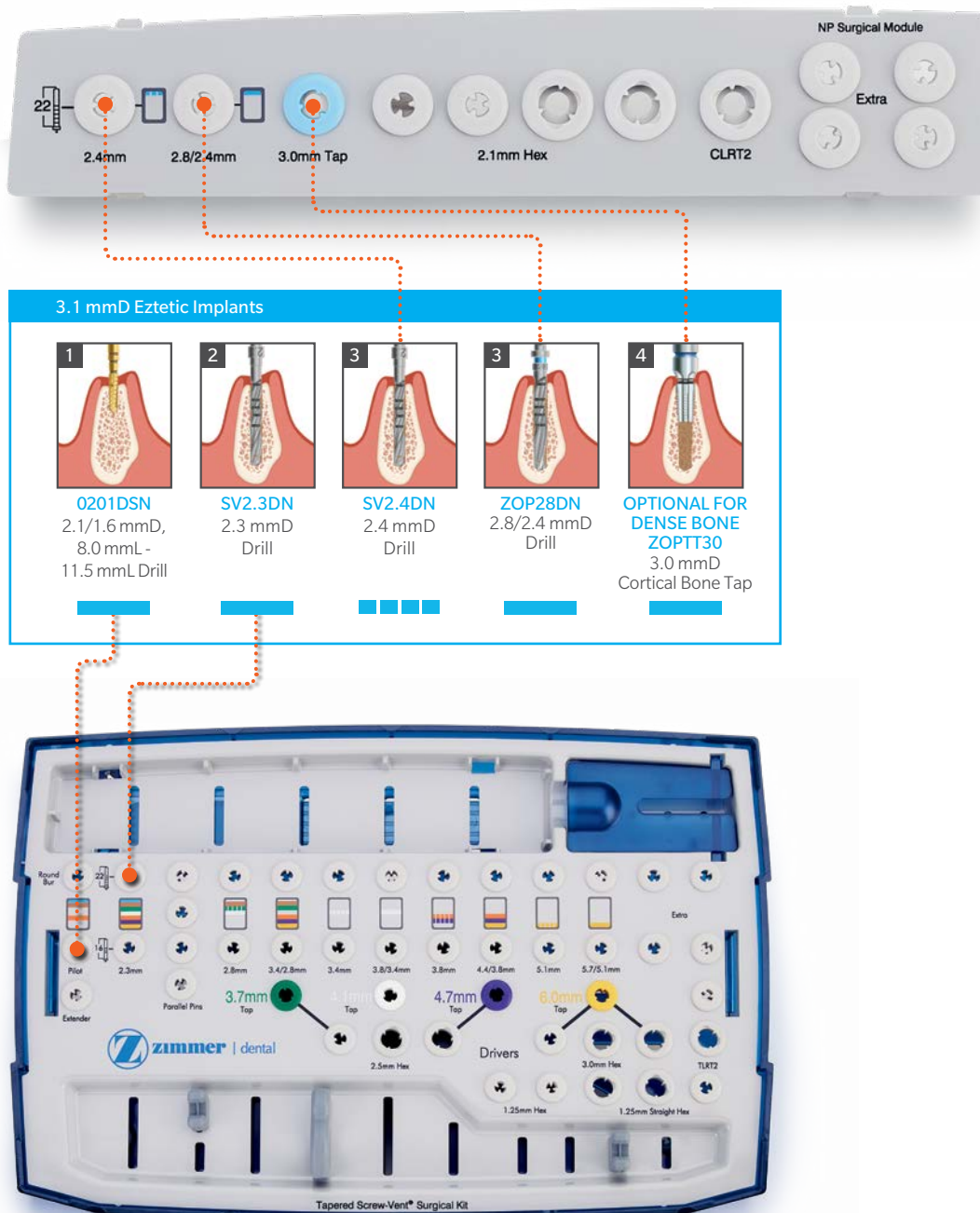

Surgical Technique

Surgical Procedure

Site Preparation

Please follow Site Preparation Instructions described in the Tapered Screw-Vent Implant System Surgical Manual along with a drilling sequence for the 3.1 mmD Eztetic Implant.

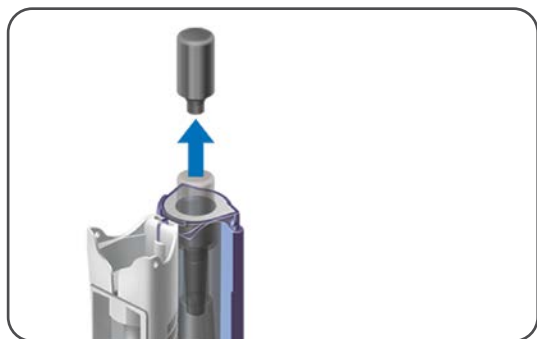

Removing The Implant From The Vial

Remove the implant outer vial from the box and open the outer vial to break the seal. Drop the sterile inner vial and contents onto a sterile field. Flip the white top of the inner vial open by pressing on the flat side with access hole. Press the top to the inner vial body to lock in the top. Grasp the top of the titanium packaging component placed on top of the implant, remove it and discard.

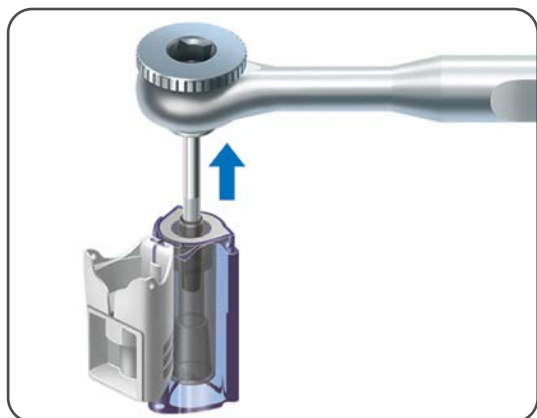

Delivering The Implant To The Site

Place the appropriate insertion instrument directly into the implant. The following instruments can be used for implant delivery to the site: the GemLock Hex Drill [CHD2.1, CHDL2.1] attached to a motor handpiece, or GemLock Hex Driver [CHR2.1, CHRL2.1] attached to the GemLock Retaining Square Ratchet [RSR] or Stainless Steel Screwdriver Handle [SSHS]. Carry the implant via the selected delivery instrument(s) to the receptor site and place directly into the prepared osteotomy.

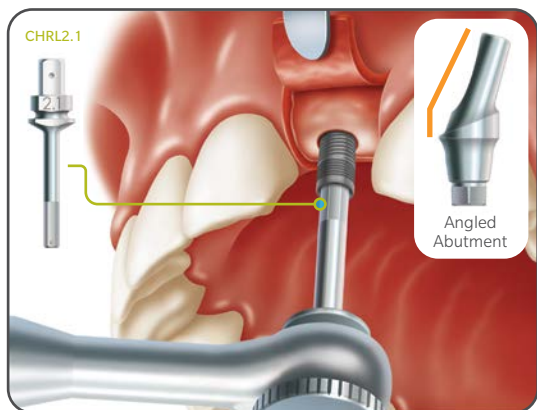
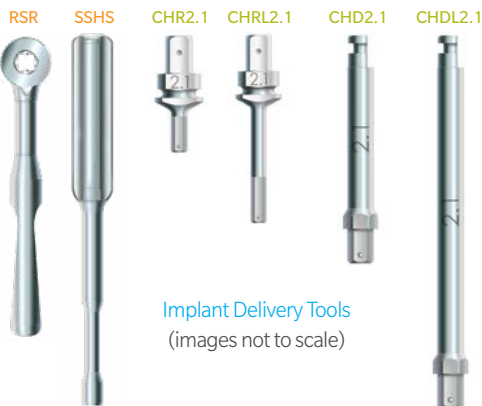

Inserting And Orienting The Implant

Rotate the implant into place with the selected delivery instrument(s). The GemLock Hex Drills and Drivers are designed with six flats to align with the implant hex. To ensure proper orientation of the Contour Abutments, align the flat side of the Hex Drill or Driver to the buccal aspect. For Angled Abutments, orient a flat side of the Hex Drill or Driver toward the direction of the implant angle. Follow One-Stage or Two-Stage Healing Instructions provided in the Instructions for Use.

Preoperative Planning

Preoperative Planning:

Proper treatment planning, as well as the selection of the proper implant length and diameter, are crucial to the long-term success of the implant and restoration.

Before an implant can be selected, the anatomical foundation available to receive the implant must be carefully assessed. Several steps should be taken to complete the evaluation:

1. Clinical examination of the oral cavity can provide important information about the health of the soft tissue at the proposed implant site. Tissue tone and the state of the superficial tissues should be evaluated. In addition, the patient should demonstrate an adequate dimension of attached gingiva or keratinized tissue at the site selected for implantation. In partially edentulous cases, the periodontal status of the remaining dentition should be assessed and interaction between the implant restoration and the adjacent natural dentition should be considered.
2. The bony foundation and ridge need to be clinically analyzed to ensure the presence of proper dimensions and the amount of bone for implant placement. At least one millimeter of bone should be present at the buccal and lingual aspects of the implant following placement. During the planning stage, it is useful to measure the existing bone foundation.

NOTE: Please ensure as many implants as necessary are used for a fully stable restoration.

CT Scans:

Computed tomography (CT) scans help surgeons view parts of the body with three-dimensional images. Image-guided surgical planning allows surgeons to see anatomical landmarks such as nerves, sinus cavities and bony structures in order to plan for the placement of dental implants and prostheses.

Through the use of CT scans, clinicians are able to more precisely measure the locations of anatomical structures, dimensions of the underlying bone and ascertain bone densities in order to plan and treat clinically demanding cases.

Radiographic Transparencies:

The vertical height of the bone can be determined radiographically. Accurate measurement of the vertical dimension on the radiograph facilitates the selection of the appropriate implant length. This helps to avoid implant placement into the maxillary sinus, the floor of the nose or the mandibular canal, and prevents perforation of the inferior aspect of the mandible. Measurements can be made directly on the panoramic radiograph using a millimeter ruler. Corrections should be made for the degree of enlargement or reduction produced by the particular radiographic equipment.

Radiographic marking balls (RMB30) of a known dimension can be embedded in a plastic template prior to radiographic examination. Once the radiograph is taken and the metal marking balls are visible on the image, measurements can be taken to determine the amount of bone available for implant placement.

To calculate the distortion factor, a simple formula can be utilized: $(5 \div A) \times B =$ the amount of actual bone available.

Formula Key =

- Radiographic marking ball = 5.0 mm in diameter.
- A = Size of marking ball image on radiograph.
- B = Length in millimeters on the radiograph of available bone between the crest of the ridge and the inferior alveolar canal.

Example:

A = 6.5 mm

B = 14 mm

Therefore: $(5 \div 6.5) \times 14 = 10.76$ mm actual bone available

NOTE: A 2.0 mm margin of safety, from the apical end of the implant to any adjacent vital structure, should be considered.

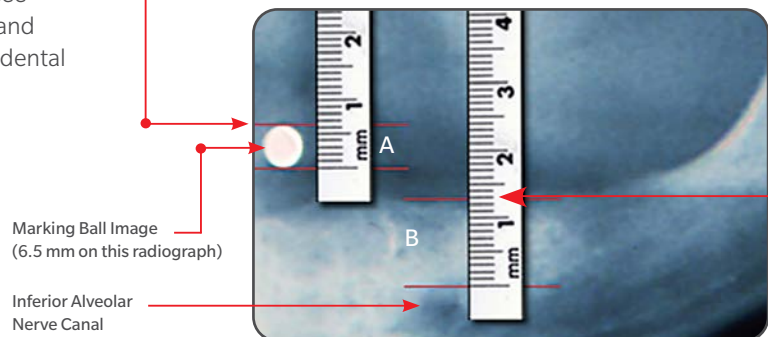

Preoperative Planning Considerations

Radiographic Transparencies Instructional Steps:

A dental implant radiographic transparency supports the preoperative implant treatment planning process. A radiographic transparency is overlaid onto a radiograph to assist the clinician in the preoperative determination of options for implant length and diameter. It is used in conjunction with a 5 mm radiographic marking ball. Representations of the implant and the 5 mm radiographic marking ball are shown on the radiographic transparency at 100%, 115%, and 125% scales.

Visually inspect the transparency before each use for damage. The transparency should not be used if damaged or deteriorated. The following steps outline the proper use of the radiographic transparency in conjunction with the 5 mm radiographic marking ball(s) during preoperative planning:

1. Overlay the 100%, 115%, and 125% scaled 5mm circular radiograph ball outline found on the transparency over the 5 mm radiographic ball image on the radiograph and determine which outline is closest to the diameter of the radiographic ball image on the radiograph. If the radiographic ball image on the radiograph extends outside the circular border of the radiographic ball outline on the 100% scale, use either the 115% or 125% scale for measurement estimations. If the radiographic ball image extends outside the circular border of the radiographic ball outline on the 125% scale, DO NOT use this radiographic transparency and refer to the Radiographic Marking Balls procedure to determine approximate bone height (See section on calculation of distortion factor on page 14).

NOTE: The radiographic ball should maintain its spherical shape on the radiograph, otherwise distortion that cannot be measured may have occurred. If this happens, it is recommended that a new radiograph be taken.

2. Select the scale (100%, 115%, or 125%) to use based on which circular radiograph ball outline best matches the diameter of the radiographic ball image on the radiograph.
3. To determine an approximation of available vertical bone height at the proposed implant site, align the zero mark on the selected ruler (100%, 115%, or 125%) to the crest of the edentulous ridge and measure the length between the crest and anatomical structures in the proposed implant site including the floor of the maxillary sinus, the floor of the nose and the mandibular canal.

NOTE: A minimum of 2 mm margin of safety, from the apical end of the implant to the adjacent vital structure, should be considered.

4. Overlay the implant silhouette corresponding to the selected scale (100%, 115%, or 125%) onto the proposed implant site to visually estimate if adequate vertical bone height is present for the selected implant length.

NOTE: The intended use of this device is exclusively for preoperative planning and to be used as a guide. Implant length and diameter should not be determined solely by relying on the radiographic transparency.

References

1. Data on file.
2. Chu C-M, Huang H-L, Hsu J-T, Fuh L-J. Influences of internal tapered abutment designs on bone stresses around a dental implant: three-dimensional finite element method with statistical evaluation. *J Periodontol* 2012;83:111-118.
3. Trisi P, Marcato C, Todisco M. Bone-to-implant apposition with machined and MTX microtextured implant surfaces in human sinus grafts. *Int J Periodontics Restorative Dent*. 2003;23(5):427-437.
4. Todisco M, Trisi P. Histomorphometric evaluation of six dental implant surfaces after early loading in augmented human sinuses. *J Oral Implantol*. 2006;32(4):153-166.
5. Shin SY, Han DH. Influence of a microgrooved collar design on soft and hard tissue healing of immediate implantation in fresh extraction sites in dogs. *Clin Oral Implants Res*. 2010;21:804-814.





Contact us at 1-800-342-5454 or visit

zimmerbiometdental.com

Zimmer Biomet Dental
Global Headquarters
4555 Riverside Drive
Palm Beach Gardens, FL 33410
Tel: +1-561-776-6700
Fax: +1-561-776-1272

Unless otherwise indicated, as referenced herein, all trademarks are the property of Zimmer Biomet; and all products are manufactured by one or more of the dental subsidiaries of Zimmer Biomet Holdings, Inc. and marketed and distributed by Zimmer Biomet Dental and its authorized marketing partners. LOCATOR is a registered trademark of ZEST IP Holdings, LLC. For additional product information, please refer to the individual product labeling or instructions for use. Product clearance and availability may be limited to certain countries/regions. This material is intended for clinicians only and does not comprise medical advice or recommendations. Distribution to any other recipient is prohibited. This material may not be copied or reprinted without the express written consent of Zimmer Biomet Dental. ZBINST1639 REVC 05/20 ©2020 Zimmer Biomet. All rights reserved.

