

Trabecular Metal™ and Tapered Screw-Vent® Implant Systems

Restorative Manual



ZIMMER BIOMET
Your progress. Our promise.

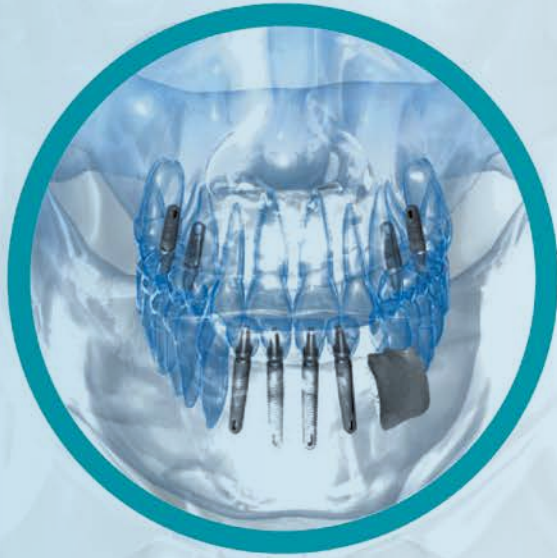

Table of Contents

Overview	3
General Information	3
Platform Plus™ Connection	3
Restorative Options	4
Partially Edentulous	4
Fully Edentulous	5
Surgical Considerations	6
Abutment Selection	7
Color Coding System	7
Temporary Components	8
Healing Collars Selection Guidelines	8
Plastic Temporary Abutments	9
Impression Transfer Techniques	13
Indirect (Closed-Tray) Transfer Technique	13
Direct (Open-Tray) Transfer Technique	16
TSV® BellaTek® Encode® Impression System	20
Cement-Retained Restorations	22
Contour Zirconia Abutments	22
Hex-Lock® Contour Abutment System	26
Hex-Lock Short Abutment System	30
Hex-Lock Abutments	34
Hex-Lock Angled Abutments	40
Custom “Cast-To” Restorations	46
“Cast-To” Gold Abutments, Engaging	46
“Cast-To” Gold Abutments, Non-Engaging	51
Screw-Retained Restorations	55
Tapered Abutment System	55
Tapered Abutment Straight	55
Angled Tapered Abutment	55
Components And Denture Options	56
Overdenture Abutments	57
LOCATOR® Overdenture Attachment System	57
Ball Abutment System	61
Prosthetic Tools	67
References	68

NOTE: Images shown throughout this manual are representational in nature and may not be to scale or display the exact geometry of the components.

General Information

The prosthetic manual for the Trabecular Metal and Tapered Screw-Vent Systems provides a detailed overview of the prosthetic procedures applicable to these implant systems. Please refer to the Instructions for Use accompanying individual components for indications, contraindications, warnings, precautions and detailed technique information.

The Platform Plus™ Connection

Abutments for the internal hex implants have a male hex that tapers one degree from the base of the abutment body to the bottom of the hex [Fig. 1]. As the abutment is seated into the implant under applied torque, the abutment hex frictionally engages the walls of the implant's internal hex. The result is a friction-fit that virtually eliminates rotation between components. Scanning Electron Micrographs reveal the intimate fit that results in a virtual "cold weld" of components [Fig. 2, 3].

- 1.5 mm deep internal hex distributes forces deeper within the implant, minimizing stress concentrations¹⁻³
- Lead-in bevel is designed to improve ability to seat the abutment properly³ [Fig. 1]
- Connection virtually eliminates rotational micromovement, tipping and effects of occlusal vibration on the abutment, the leading causes of screw loosening³
- Low profile of the internal connection is designed to allow for improved aesthetics and a better emergence profile³
- Once the friction-fit is established, abutments can only be unseated from the implant with a special Abutment Removal Tool [Fig. 4]
- Three prosthetic platforms are available for Trabecular Metal and Tapered Screw-Vent Implants: 3.5 mmD, 4.5 mmD and 5.7 mmD.



Fig. 2 SEM at 50X magnification shows intimate contact of the internal hex implant at both the beveled implant/abutment interface and the hexagonal engagement area.



Fig. 3 SEM at 150X magnification displays the mechanical interlock in the hexagonal engagement area between the flats of the implant and abutment.

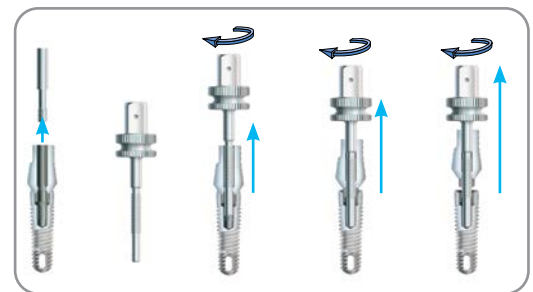

Fig. 4 To remove a fully seated friction-fit abutment from the implant, the abutment screw must first be unthreaded and removed from the abutment body. An Abutment Removal Tool [TLRT2] is then threaded through the abutment and into the implant. As the tool continues rotating, it will disengage the friction-fit connection and gently lift the abutment body off of the implant.

Partially Edentulous

Abutment for Cemented Crown

Implant-supported prosthesis

- The prosthesis is removable only by the dentist
- Interdigitates with the implant's hex for anti-rotational stability
- Forms a friction-fit that virtually eliminates the major causes of screw loosening
- Prosthetic design should reflect cosmetic and hygiene considerations
- Abutment types: Hex-Lock Contour, Hex-Lock Short, Hex-Lock, Angled and "Cast-To" Gold Abutment options



Abutment for Screw-Retained Crown or Combined Post and Crown

Implant-supported prosthesis

- The prosthesis is removable only by the dentist
- Interdigitates with the implant's hex for anti-rotational stability
- Forms a friction-fit that virtually eliminates the major causes of screw loosening
- Prosthetic design should reflect cosmetic and hygiene considerations
- Provides options for screw-retained crown and combined post & crown
- Abutment type: "Cast-To" Gold Abutment



Abutment for Cement-Retained Bridge

Implant-supported prosthesis

- The prosthesis is removable only by the dentist
- Interdigitates with the implant's hex for anti-rotational stability
- Forms a friction-fit that virtually eliminates the major causes of screw loosening
- Prosthetic design should reflect cosmetic and hygiene considerations
- Abutment types: Hex-Lock Contour, Hex-Lock Short, Hex-Lock, Angled and "Cast-To" Gold Abutment options



Abutment for Screw-Retained Bridge

Implant-supported prosthesis

- The prosthesis is removable only by the dentist
- Prosthetic design should reflect cosmetic and hygiene considerations
- Abutment types: Tapered Abutment ; "Cast-To" Gold Abutment, Non-Engaging



Restorative Options



Fully Edentulous

Fixed Screw-Retained Denture

Implant-retained, implant-supported prosthesis

- This prosthesis is recommended primarily for the mandible
- The prosthesis is removable only by the dentist
- The secure fit offers the psychological advantage of a fixed prosthesis
- Five to six implants are preferred for the mandibular prosthesis
- Six to ten implants are preferred for the maxillary prosthesis
- Prosthetic design should reflect cosmetic and hygiene considerations
- Abutment types: Tapered Abutment; "Cast-To" Gold Abutment, Non-Engaging

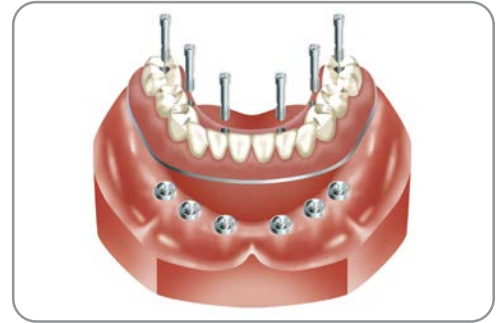

Bar Overdenture

Implant-retained, implant-supported prosthesis

- This prosthesis is recommended for the maxilla and mandible
- The overdenture is removable by the patient to facilitate hygiene and eliminate stress on the implant/prosthetic system when removed
- The overdenture is stable and feels natural to the patient
- Four to six implants are preferred for the mandibular prosthesis
- Six to ten implants are preferred for the maxillary prosthesis
- Various attachments are used to affix the denture to the bar
- Abutment types: Tapered Abutment; "Cast-To" Gold Abutment, Non-Engaging



Ball Bar Overdenture

Implant-retained, tissue-supported prosthesis

- This prosthesis is recommended primarily for the mandible
- The overdenture is removable by the patient to facilitate hygiene and eliminate stress on the implant/prosthetic system when removed
- Slight prosthetic movement, but is stable and feels natural to the patient
- Four implants are preferred for the Ball Bar Overdenture
- Abutment types: Tapered Abutment; "Cast-To" Gold Abutment, Non-Engaging; LOCATOR Bar Attachments; Castable ball patterns also available



Ball Abutment or LOCATOR Abutment Overdenture

Implant-retained, tissue-supported prosthesis

- This prosthesis is recommended primarily for the mandible
- The overdenture is removable by the patient to facilitate hygiene and eliminate stress on the implant/prosthetic system when removed
- Denture movement is necessary, due to the limited number of implants
- Retained by Ball Abutments or LOCATOR Abutments on two implants
- Two implants are required for a Ball Abutment or LOCATOR Abutment Overdenture
- Abutment type: Ball Abutment, LOCATOR Abutment



Surgical Considerations

Two- and One-Stage Surgical Procedures

Submerged (Two-Stage) Surgical Protocol

The submerged surgical protocol is the traditional method of placing root-form dental implants. Two-stage implant designs come preattached to a fixture mount, and are presterilized in double-vial packaging. After the implant is placed, the fixture mount is removed and a low-profile Titanium Surgical Cover Screw is threaded into the top of the implant. The soft-tissue is then sutured over the implant, which remains submerged until osseointegration is achieved.

Placing a Healing Collar at The Second-Stage Surgery

A second surgery is then performed to expose the top of the implant. At this time, the cover screw is removed and a transmucosal Healing Collar is attached to the implant. The soft-tissue is sutured around the Healing Collar and allowed to heal. Once the peri-implant soft-tissue sulcus has formed, prosthetic procedures are initiated by removing the Healing Collar to gain access to the top of the implant.

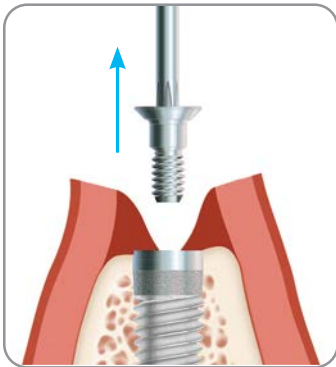

After the top of the implant is surgically exposed, unthread the Titanium Surgical Cover Screw from the implant with a 1.25 mmD Hex Tool [HXGR1.25, HXLGR1.25].

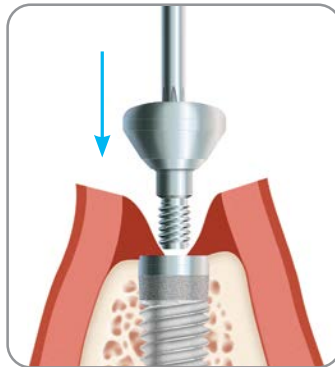

Select a 3.0 mm- or 5.0 mm-long Healing Collar according to the thickness of the surrounding soft-tissue. Use a 1.25 mmD Hex Tool [HXGR1.25, HXLGR1.25] to thread the Healing Collar into the implant.

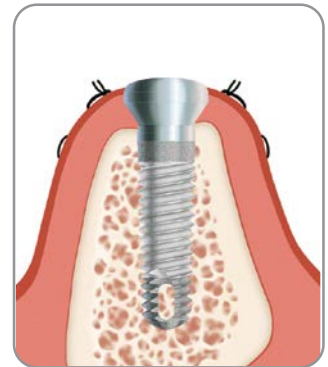

Suture the soft-tissue around the Healing Collar.

Non-Submerged (One-Stage) Surgical Protocol

The one-stage surgical protocol eliminates the implant-uncovering, second-stage surgery mentioned above. The non-submerged surgical protocol may be performed by placing the appropriate healing collar or provisional restoration directly after implant placement and suturing around the healing collar or restoration to maintain the soft-tissue opening during the implant healing phase.

Abutment Selection

All hex-engaging abutments achieve a friction-fit with the implant, regardless of the implant's design or type of connection. The abutments are assemblies that consist of a one- or two-piece abutment body and an abutment screw. The base of the abutment body contains an external hex that interdigitates with the mating internal hex of the implant. This engagement prevents rotation when the abutment screw is threaded into the implant. To complete seating and fully engage the friction-fit, the abutment screw must be tightened to 30 Ncm. These components require the Removal Tool [TLRT2] to assist in the removal of the hex-engaging component from the implant once the abutment screw has been removed.

All non-engaging components ("Cast-To" Non-Engaging, Tapered and Ball Abutments), do not engage the hex of the implant and can only be used for multiple-unit splinted restorations or attachment overdentures.

Submerged or Non-Submerged Surgical Protocol

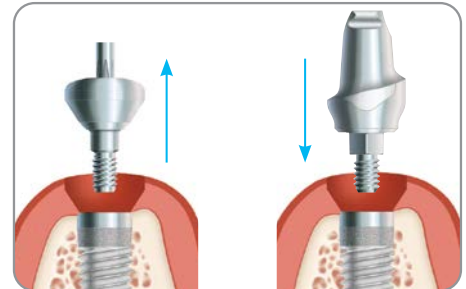

Remove the Healing Collar or provisional prosthesis placed at time of first- or second-stage surgery. Attach the abutment directly to the implant.

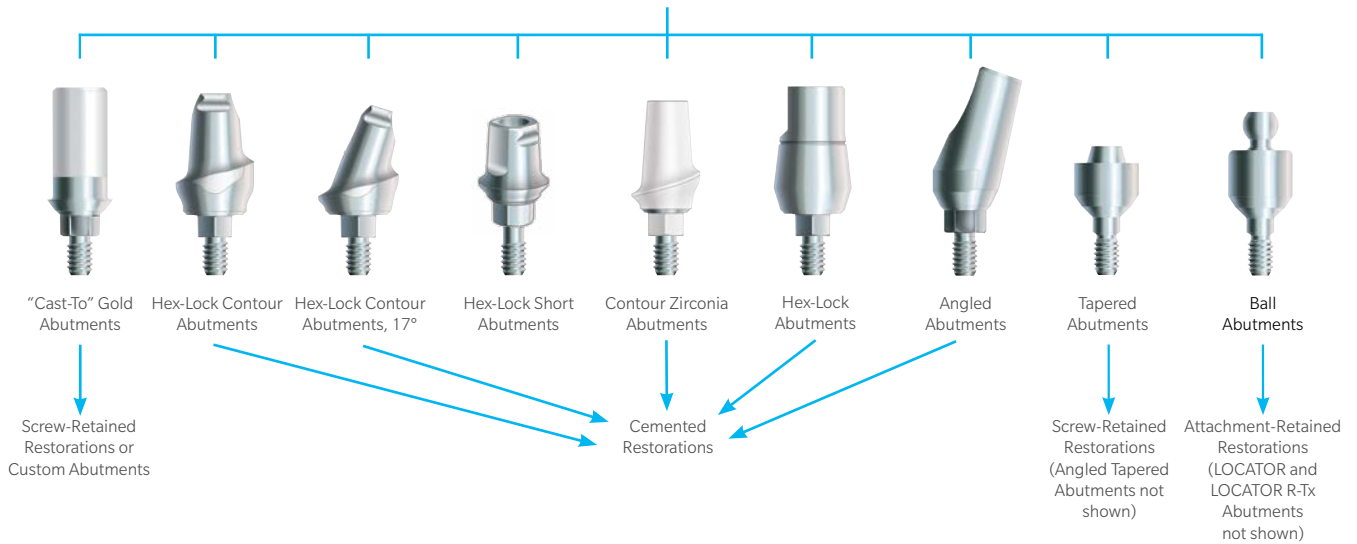

Color Coding System

Trabecular Metal and Tapered Screw-Vent Implants are available in multiple sizes with three color-coded prosthetic platforms: 3.5 mmD, 4.5 mmD and 5.7 mmD. Choose the implant prosthetic platform you wish to restore, then follow the color-coding to identify the appropriate components for your procedure.

Implant Platform Color-Coding

Implant Diameter	Implant Platform	Color-coding	
3.7 mmD	3.5 mmD	● Green	Green
4.1 mmD	3.5 mmD		
4.7 mmD	4.5 mmD	● Purple	Purple
6.0 mmD	5.7 mmD	● Yellow	Yellow

Abutment Emergence Profile*	Color-coding	
4.5 mmD	● Tan	Tan
5.5 mmD	● Rose	Rose
6.5 mmD	● Yellow	Yellow

* For Hex-Lock Contour and Short Restorative components.

Healing Collar Selection Guidelines

Selecting a Healing Collar:

- Determine the size of the implant platform
- Select the emergence profile that best suits the site being restored. The profile should match the transfer and abutment to be used
- Select the cuff height so that the top of the component protrudes slightly above the surrounding tissue. The options are 3.0 mm, 5.0 mm or 7.0 mm

HC3/TEHA3 = 3.5 mmD (Implant Platform) Healing Collar
 HC4/TEHA4 = 4.5 mmD (Implant Platform) Healing Collar
 HC5/TEHA5 = 5.7 mmD (Implant Platform) Healing Collar

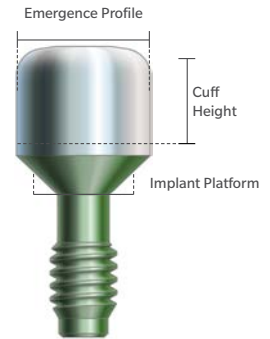

Example:

HC343 = 3.5 mmD (Implant Platform) Healing Collar, 4.5 mmD Emergence Profile, 3.0 mm Cuff Height (second digit equals profile, third digit equals height)

TEHA3383 = 3.5 mmD (Implant Platform) Healing Collar, 3.8 mmD Emergence Profile, 3.0 mm Cuff Height (middle two digits equals profile, last digit equals height)

TSV BellaTek® Encode® Healing Abutments

Healing collar and impression coping enabling definitive abutment design by your Encode Empowered Laboratory.*



Implant Platform	Emergence Profile	Cuff Height		
		3.0 mm	5.0 mm	7.0 mm
● 3.5 mmD	3.8 mmD	TEHA3383	TEHA3385	TEHA3387
● 3.5 mmD	5.0 mmD	TEHA3503	TEHA3505	•
● 4.5 mmD	5.0 mmD	TEHA4503	TEHA4505	•
● 4.5 mmD	5.6 mmD	TEHA4563	TEHA4565	TEHA4567
● 4.5 mmD	6.0 mmD	TEHA4603	TEHA4605	•
● 5.7 mmD	6.8 mmD	TEHA5683	TEHA5685	•

*Not available in all markets.

Healing Collars



Implant Platform	Emergence Profile	Cuff Height		
		3.0 mm	5.0 mm	7.0 mm
● 3.5 mmD	3.5 mmD (No Flare)	HC333	HC335	•
● 3.5 mmD	4.5 mmD	HC343	HC345	HC347
● 3.5 mmD	5.5 mmD	HC353	HC355	•
● 4.5 mmD	4.5 mmD (No Flare)	HC443	HC445	•
● 4.5 mmD	5.5 mmD	HC453	HC455	HC457
● 4.5 mmD	6.5 mmD	HC463	HC465	•
● 5.7 mmD	6.5 mmD	HC563	HC565	•

Temporary Components

Plastic Temporary Abutments

Considerations:

- Facilitates screw- and cement-retained provisional restorations
- Used to fabricate an aesthetic temporary restoration and develop an aesthetic gingival emergence during the healing period and prior to final restoration
- Intraoral use limited to 180 days
- Not to be used "in occlusion"
- Not to be used as a "cast-to" abutment
- Not to be reduced to less than 4.0 mm in height
- Do not use a torque wrench. Hand-tighten only

Specifications:

- Packaged with long (preparable) and short retaining screw to facilitate screw- and cement-retained provisional restorations
- Platform Sizes: 3.5 mm, 4.5 mm, 5.7 mm (Straight) and 3.5 mm, 4.5 mm (Angled)
- Cuff Heights: 1.0 mm, 4.0 mm

Instrumentation Needed:

- 1.25 mmD Hex Tool [HXGR1.25, HXLGR1.25, HX1.25, HXL1.25]

For additional information, refer to the Instructions for Use located at <https://labeling.zimmerbiomet.com>.



Fabricating the Articulated Casts

Pour the working cast in dental stone. Use soft-tissue material to represent gingival contours if desired. Remove transfers from cast. Pour the opposing- arch impression in dental stone and utilize interocclusal bite registration to articulate the casts.



Creating a Diagnostic Wax-Up

Create a diagnostic wax-up of the teeth to be replaced using traditional prosthodontic techniques with proper tooth morphology. Duplicate the diagnostic wax-up by recording an alginate impression, and pour a plaster cast. Use a vacuum machine to create the plastic matrix.

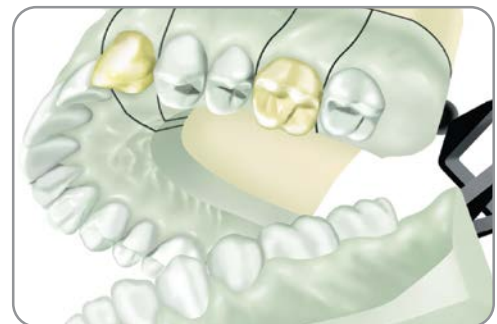

Preparing the Plastic Shell Form

Remove the plastic matrix and form the duplicated cast. Trim and re-seat the clear matrix and check fit. Drill a small hole in the occlusal aspect of the matrix and reseat it over the Temporary Abutment, allowing the abutment screw of the Plastic Temporary Abutment to protrude through.

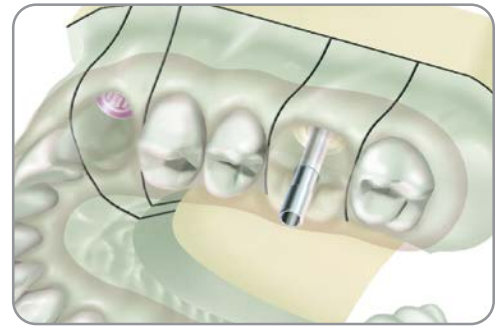

Attaching the Abutments to the Working Cast

Attach the corresponding Plastic Temporary Abutments to the Implant Analogs or to the implants in a chairside procedure. Use a 1.25 mmD Hex Tool [HXGR1.25, HXLGR1.25, HX1.25, HXL1.25] to tighten the abutment screw, using finger-pressure only.

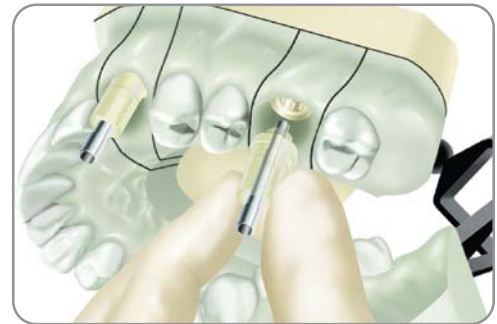

Preparing the Temporary Abutment

Mark the required modifications on the abutment to allow for the appropriate occlusal clearance, gingival contouring and prosthesis design for adequate thickness of veneering material. **NOTE:** When fabricating multiple-unit screw-retained restorations, one or all of the abutment's hex connection may need to be removed to avoid interference of the multiple hexes when seating the restoration.

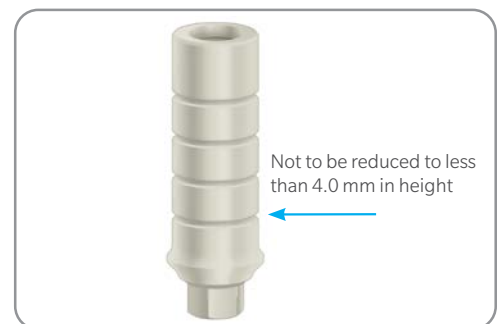

Modifying the Abutment

Screw-retained (molar shown): Reduce the abutment height as necessary, leaving the abutment screw long to protrude through the vacuum form.

Roughen the entire abutment surface to enhance retention of the acrylic.
Cement-retained (canine shown): Reduce and prepare the abutment and screw as needed. Roughen the abutment surface to enhance retention of the cemented restoration.



Temporary Components

Preparing the Cast for Temporary Material

Screw-retained (molar shown): Block out undercuts and apply separating medium to the cast, ensuring none is applied to the Temporary Abutments.

Cement-retained (canine shown): Cover the abutment with wax or petroleum jelly to prevent adherence of temporary material.

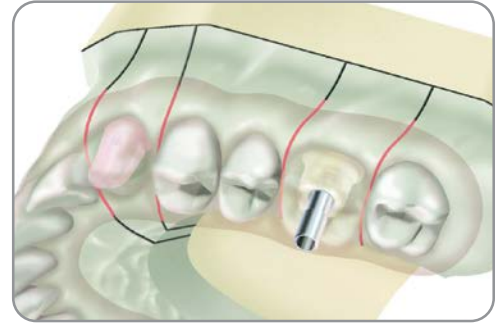

Sealing Voids and Margin

To avoid ingress of excess monomer in the indicated areas, seal the void around the screw as it enters the screw access channel. Seal the junction of the abutment to the analog in a similar fashion. Do not apply monomer as a whetting agent directly to the abutment.

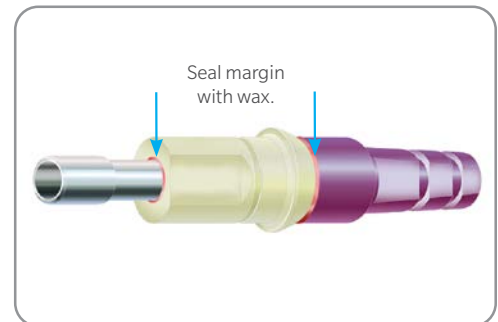

Fabricating the Provisional Prosthesis

Allow the screw to pass through the vacuform, fill the vacuform with temporary material and place over the trimmed abutments. Follow manufacturer's guidelines to cure temporary material.

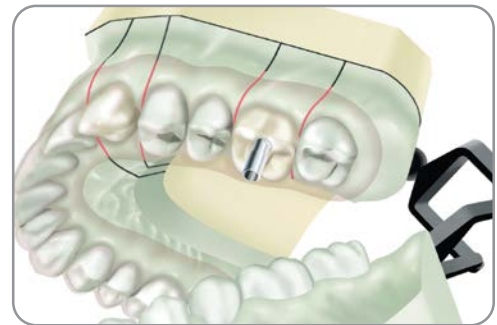

Completing the Provisional Prosthesis

Follow standard laboratory procedures to complete both the cement- and screw-retained provisional prostheses. Trim the abutment screws to accommodate lingual, occlusal and incisal contours.



Delivering the Provisional Prosthesis

Screw-retained (molar shown): Attach the one-piece abutment/provisional to the implant and check the occlusion. Tighten the abutment screw, reduce the screw shaft by cutting with a fissure bur and block out the screw access hole.

Cement-retained (canine shown): Tighten the abutment screw and block out the screw access hole. Cement the provisional with temporary cement and check the occlusion.



The Provisional Prosthesis

Completed provisional restorations are in place.

NOTE: The gingival contours of the temporary prosthesis may not match the flare of the temporary cuffs or the final prosthetic abutment. Additional treatment planning and or modifications to the Temporary Abutment may be needed to accommodate specific tissue contour.

NOTE: Do not use a torque wrench to secure the Temporary Abutment to the implant body. Hand-tighten only.



Impression Transfer Techniques

Indirect (Closed Tray) Impression Transfers

Considerations:

- For use in recording an impression
- Can be used as a general transfer method to record the implant position including orientation of the implant's respective anti-rotational feature to a master model
- Designed to remain attached to the implants when the close-tray impression is removed from the mouth

Specifications:

- Optional longer transfer screw available adds 3.0 mm height [HLTE]
- Platform Sizes: 3.5 mm, 4.5 mm, 5.7 mm
- Emergence Profiles: 3.5 mm, 4.5 mm, 5.5 mm, 6.5 mm

Instrumentation Needed:

- 1.25 mmD Hex Tool [HXGR1.25, HXLGR1.25, HX1.25, HXL1.25]

For additional information, refer to the Instructions for Use located at <https://labeling.zimmerbiomet.com>.



Exposing the Tops of the Implants

Tapered Screw-Vent Implants:

- Remove the Healing Collars with the 1.25 mmD Hex Tool [HXGR1.25, HXLGR1.25].



Attaching the Transfers

Indirect Transfers are available in various profile diameters to replicate anatomical tissue sulcus in the working cast. Orient the flat side of the Indirect Transfer [HLT Series] or Fixture Mount/Transfer toward the buccal surface, interdigitate its hex with the implant's hex and press the transfer onto the implant. Thread the transfer screw into the implant and finger-tighten with the 1.25 mmD Hex Tool [HXGR1.25, HXLGR1.25, HX1.25, HXL1.25].



Making the Transfer Impression

Take a radiograph or use a non-abrading explorer to verify that the Indirect Transfers are fully seated. Block out the hex holes in the tops of the transfer screws with medium of choice to prevent the ingress of impression material. Remove excess material so that the block-out is flush with the ends of the transfer screws. Failure to do so may prevent an accurate transfer procedure.



Verifying the Fit of The Impression Tray

Verify that the Indirect Transfers fit within the confines of the custom tray or the modified stock tray prior to injecting the impression material.

In areas where a greater length of transfer body is required, replace the transfer screw with the Extension Screw [HLTE] for two-stage internal hex implants. This will increase the length of the transfer by 3.0 mm and provide another circumferential groove for added vertical retention.

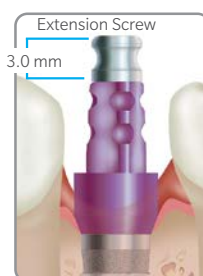

Injecting the Impression Material

An elastomeric impression material is recommended, such as vinyl polysiloxane. Inject light-body impression material around the transfers and fill the closed tray with heavier-body impression material. Make a full-arch impression, and allow the material to set according to the manufacturer's recommendations before removing. Unthread the Indirect Transfers from the implants in the patient's mouth. Make interocclusal records and an impression of the opposing arch. Send the impressions and transfer assemblies to the laboratory for fabrication of the working casts. Replace the Healing Collars on the implants in the patient's mouth.

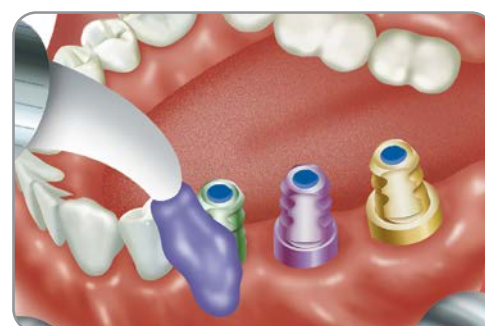

Seating the Transfer Assembly

Attach the Indirect Transfers to corresponding Implant Analogs with the Hex Tool [HXGR1.25, HXLGR1.25, HX1.25, HXL1.25]:

- Implant Analog for an internal hex implant, 3.5 mmD platform: [IA3](#).
- Implant Analog for an internal hex implant, 4.5 mmD platform: [IA4](#).
- Implant Analog for an internal hex implant, 5.7 mmD platform: [IA5](#).

Align the flat side of each transfer with the flat side of its corresponding hole in the impression and insert the transfer assembly into the impression material. A double-click will indicate when the assembly has fully seated.

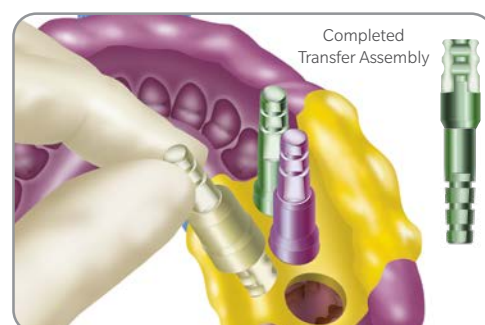

Impression Transfer Techniques

Cross-Section of Transfer Impression

From the cross-section of the Indirect Transfer impression, note that there is no access to the transfers from outside of the impression tray.

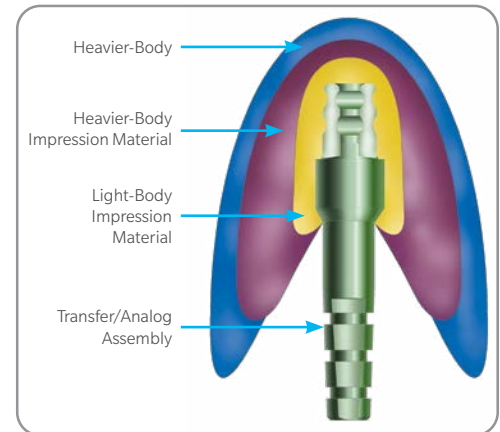

Fabricating the Working Cast

Place soft-tissue replication material around the junctions of the assembled Implant Analogs and the transfers inside the impression. Take care not to cover the retention grooves of the Implant Analogs with the material. After the material sets, pour the impression in dental stone.

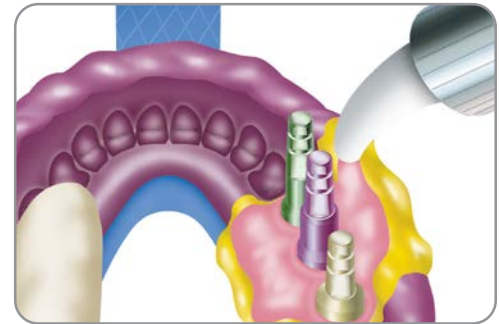

Fabricating the Working Cast

After the dental stone sets separate the cast from the impression. The Implant Analogs will be incorporated within the stone cast with the same hex positions and orientations as the implants in the patient's mouth. Unthread and remove the transfers from the Implant Analogs with the Hex Tool [[HXGR1.25](#), [HXLGR1.25](#), [HX1.25](#), [HXL1.25](#)]. The soft-tissue replication material can be removed for a visual inspection of the abutment/Implant Analog connections, if desired.

Pour the opposing-arch impression in dental stone, then utilize the interocclusal records to articulate the casts.

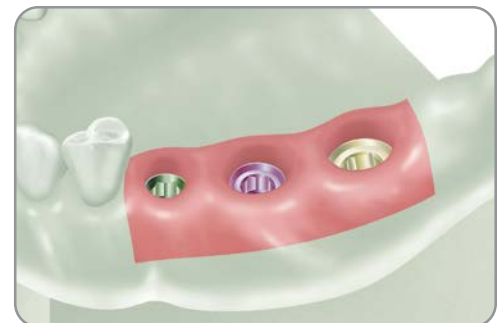

Direct (Open Tray) Impression Transfers

Considerations:

- For use in recording an impression
- Can be used as a general transfer method to record the implant position including orientation of the implant's respective anti-rotational feature to a master model

Specifications:

- Requires a custom tray or modified stock tray
- Platform Sizes: 3.5 mm, 4.5 mm
- Emergence Profiles: 3.5 mm, 4.5 mm, 5.5 mm, 6.5 mm

For additional information, refer to the Instructions for Use located at <https://labeling.zimmerbiomet.com>.

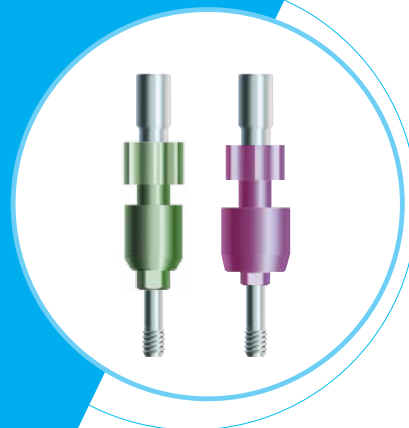

Fabricating a Custom Tray

Make a full-arch impression of the Healing Collars or Surgical Cover Screws, edentulous areas and remaining dentition. Send it to the laboratory for fabrication of a preliminary cast and custom impression tray. Alternatively, select a stock tray and mold the border with greenstick compound material. The patient's existing, modified prosthesis can continue to be worn during the laboratory phase.



Pour the impression in dental stone and separate the preliminary cast after it sets. Block out the areas above the Healing Collars or Surgical Cover Screws with baseplate wax to simulate the positions of the implant transfers that will be used.

Fabricate the custom impression tray with autopolymerizing or light-cure tray resin. Create an opening above the implant areas to allow for access to the Direct Transfer screws.



Removing the Healing Components

Expose the tops of the implants. Remove the Healing Collars or Surgical Cover Screws with the 1.25 mmD Hex Tool [HXGR1.25, HXLGR1.25].

Select the transfers according to the implant platform and the required profile diameters. Place a Direct Transfer onto each implant in the patient's mouth by interdigitating its hex with the hex of the implant.



Impression Transfer Techniques

Attaching the Direct Transfers

Use the 1.25 mmD Hex Tool [HXGR1.25, HXLGR1.25, HX1.25, HXL1.25] to thread the transfer screws through the transfer bodies and into the implants, then finger-tighten. In areas of limited vertical height, the transfer screws can be removed and shortened by 4.0 mm with a cutting disc prior to use.

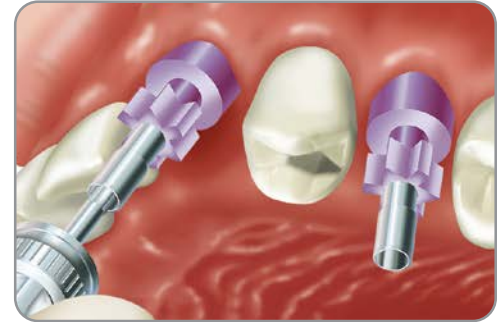
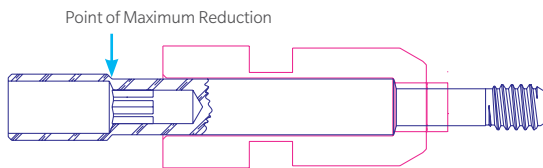

Verifying Screw Access Through the Top of the Tray

Place the open-access tray over the assembled Direct Transfers in the patient's mouth to verify that the screws penetrate through the top of the tray without hindrance. Remove the open-access tray.



Making the Transfer Impression

An elastomeric impression material is recommended, such as vinyl polysiloxane. Inject light-body impression material around the Direct Transfers and fill the open-access tray with heavier-body impression material. Place the loaded tray into the patient's mouth and allow the screws to penetrate through the access area in the impression tray. Remove excess impression material from the tops of the screws and allow the impression material to set according to the manufacturer's recommendations. Unthread the screws from the transfers with the Hex Tool [HXGR1.25, HXLGR1.25, HX1.25, HXL1.25] and remove them from the patient's mouth. Remove the tray from the mouth. The Direct Transfer bodies will be picked up and retained in the impression material.

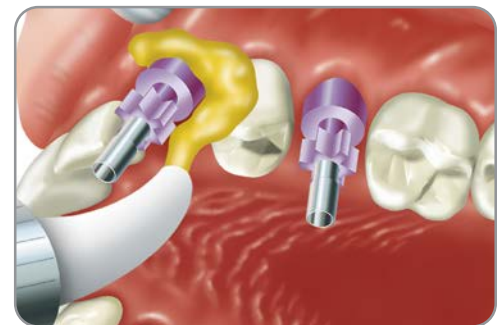

Completing the Transfer Procedure

Replace the healing components on the implants in the patient's mouth. Fabricate an opposing-arch impression and make interocclusal records. Send the impressions with included transfers to the laboratory for fabrication of the working casts. Stabilize each Implant Analog [IA3, IA4 or IA5] with forceps to prevent rotation, and insert the screw-receiving end of a corresponding Implant Analog into the base of the transfer body within the impression material.

Attach the transfer screw to the 1.25 mmD Hex Tool [HXGR1.25, HXLGR1.25, HX1.25, HXL1.25], and insert it through the respective access hole in the back of the transfer tray. Pass the screw through the embedded transfer body and thread it into the attached Implant Analog to lock the components together.

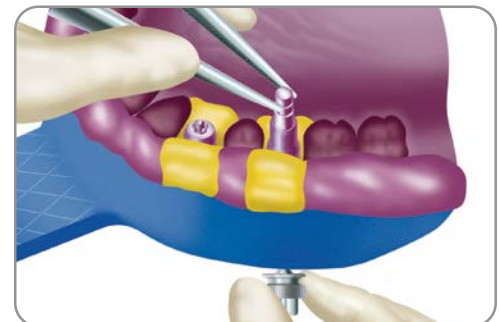

Cross-Section of Transfer Impression

From the cross-section of the Direct Transfer impression, note that there is access to the transfer screw from outside of the impression tray.

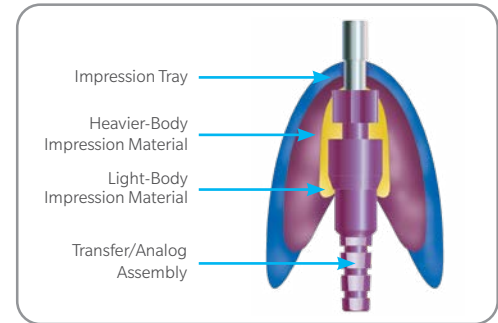

Fabricating the Working Cast

Place soft-tissue replication material around the junctions of the assembled Implant Analogs and the transfers inside the impression. Take care not to cover the retention grooves of the Implant Analogs with the material.

After the material sets, pour the impression in dental stone.



Fabricating the Working Cast

Use the 1.25 mmD Hex Tool [HXGR1.25, HXLGR1.25, HX1.25, HXL1.25] to unthread and remove the transfer screws after the dental stone sets. Separate the cast from the impression (the open-tray transfer bodies will remain in the impression). The Implant Analogs will be incorporated within the stone cast with the same hex positions and orientations as the implants in the patient's mouth. The soft-tissue replication material can be removed for a visual inspection of the abutment/implant analog connections, if desired.

Pour the opposing-arch impression in dental stone, then utilize the interocclusal records to articulate the casts.

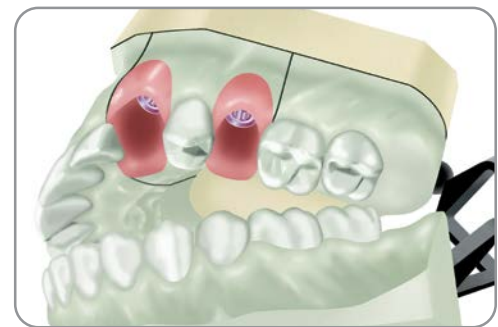

Option 1: Making an Implant-Level Impression

After threaded implant placement, block out the top of the Fixture Mount/Transfer. If implant does not have a transfer, attach transfer of choice with 1.25 mmD Hex Tool [HXGR1.25, HXLGR1.25, HX1.25, HXL1.25]. Place light-body impression material around the transfer and record a full-arch impression with standard body material.

Remove the impression after it fully sets. Remove transfer and forward with impression to the laboratory. If impression is done at the bone level, inform the laboratory. Optional: Long Impression Screw [DHTS] may be used for open-tray impression technique.

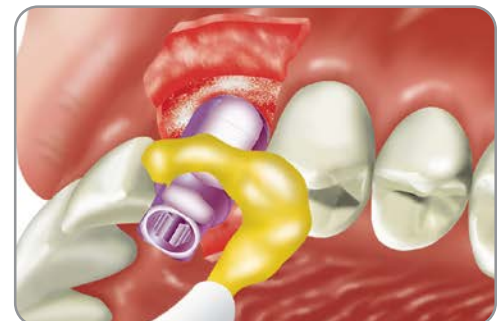

Impression Transfer Techniques

Option 2: Using the Surgical Guide for Indexing

After threaded implant placement, use a Long (Open-Tray) Impression Screw [DHTS] to project through surgical guide. Lute the Fixture Mount/Transfer or transfer post to the surgical guide with resin of choice. Unscrew the transfer and remove the guide with transfer attached. Forward guide and transfer to the laboratory for retrofitting of the preoperative model.



Attaching Components for Healing Period

- Place Surgical Cover Screw using 1.25 mmD Hex Tool [HXGR1.25, HXLGR1.25] and then suture for traditional two-stage protocol.
- Attach a Healing Collar with the corresponding profile and platform diameter for single-stage protocol.

Forward the impression, transfer and diagnostic models to the laboratory for fabrication of the working cast.

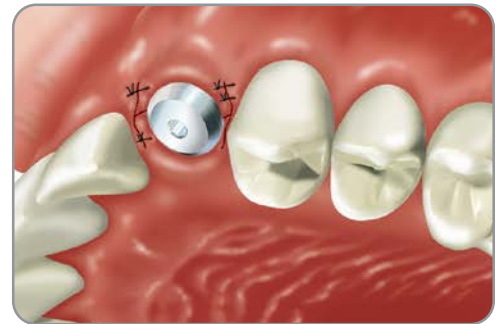

Fabricating the Working Cast

Place soft-tissue replication material around the junctions of the assembled Implant Analog and the transfer inside the impression. After the material sets, pour the impression in dental stone. Separate the cast from the impression. The Implant Analog will be incorporated within the stone cast with the same hex positions and orientations as the implant in the patient's mouth. Unthread and remove the transfer from the Implant Analog with the 1.25 mmD Hex Tool [HXGR1.25, HXLGR1.25, HX1.25, HXL1.25]. The soft-tissue replication material can be removed for a visual inspection of the abutment/Implant Analog connections, if desired.

Pour the opposing-arch impression in dental stone, then utilize the interocclusal records to articulate the casts.

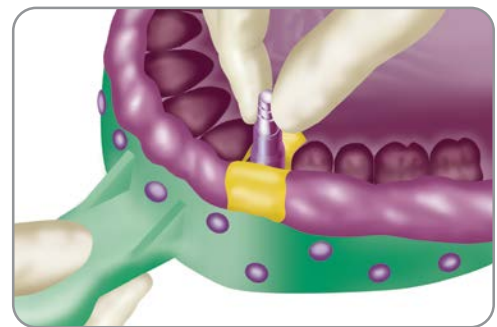

TSV BellaTek Encode Impression System

Considerations:

- Utilizes the TSV BellaTek Encode Healing Abutment in a traditional or digital impression
- Eliminates the need for a separate impression coping, reducing the need for multiple prosthetic removals
- Encode Coding scheme on the occlusal surface transfers implant size and position for fabrication of a definitive abutment by an Encode Empowered Laboratory
- Larger cases of three or more units should include a diagnostic wax up
- A metal or resin framework try-in is recommended for multi-unit cases

Specifications:

- Platform Sizes: 3.5 mm, 4.5 mm, 5.7 mm
- Emergence Profile: 3.8 mm, 5.0 mm, 5.6 mm, 6.0 mm, 6.8 mm
- Cuff Height: 3.0 mm, 5.0 mm, 7.0 mm

Instrumentation Needed:

- 1.25 mmD Hex Tool

For additional information, refer to the Instructions for Use located at <https://labeling.zimmerbiomet.com> and the TSV BellaTek Encode Restorative Procedure (ZBINST0024).



Traditional Impression

Use a light body impression material around the healing abutment(s) and a medium body elastomeric impression material (polyether or polyvinyl) in the impression tray and seat in the mouth.

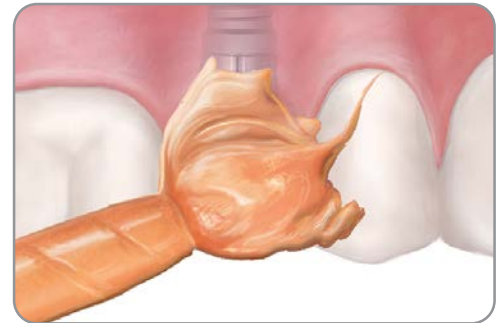

After the impression material has set, remove the tray from the mouth. Verify that a clear impression (no rips, tears, bubbles or distortions) has been made of all the TSV BellaTek Encode Healing Abutment markings, the entire circumference of the healing abutment and soft-tissue contours have been captured.



Take an impression of the opposing arch and bite registration.

Select shade for crown. Disinfect and package the impressions and send to your Encode Empowered Laboratory for definitive abutment design.



Digital Impression with Intra-Oral Scanner

Scan the TSV BellaTek Encode Healing Abutment with an intraoral scanner following the manufacturer's instructions.

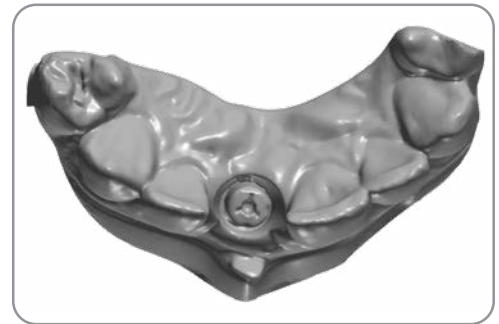

Verify that a clear scan has captured all the TSV BellaTek Encode Healing Abutment(s) markings, all the soft-tissue contours and the entire circumference of the healing abutment.

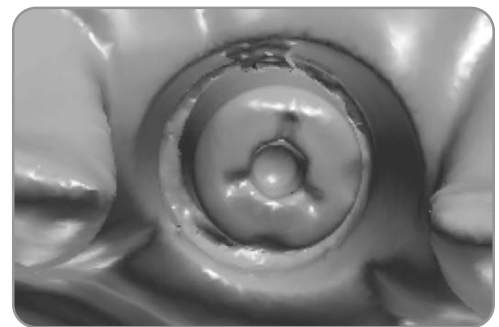

Scan the opposing arch and bite registration.

Submit scan to your Encode Empowered Laboratory.

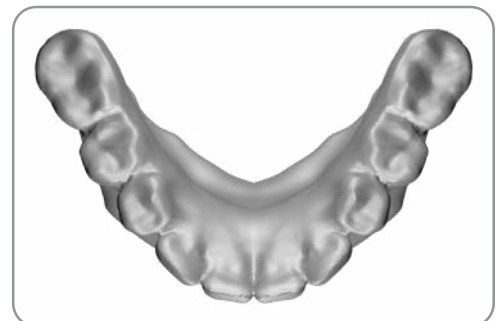

Contour Zirconia Abutments

Considerations:

- Used as a terminal or intermediate abutment for a cemented prosthesis
- For single or multiple-unit implant-supported restorations
- 3.5 mm Straight Zirconia Abutment is used in the anterior, cuspid and premolar regions.
The 4.5 mm Straight Zirconia Abutment can be used in any region of the mouth
- Angled abutment supports restorations where the angle needs to be offset by 17°
- 3.5 and 4.5 mm Angled Zirconia Abutments are used in the anterior, cuspid and premolar regions
- Contour Zirconia Abutments feature a pre-defined offset margin that is lower on the buccal and higher on the lingual aspect
- Not to be used as “cast-to” abutments
- Not for use in the molar region
- Angled: Not for use with implants requiring greater than 25° of correction to long axis

Specifications:

- Platform Sizes: 3.5 mm, 4.5 mm
- Emergence Profiles: 4.5 mm, 5.5 mm (Straight) and 5.0 mm, 6.0 mm (Angled)
- Cuff Heights: 1.0 mm, 2.0 mm

Instrumentation Needed:

- 1.25 mmD Hex Tool [HXGR1.25, HXLGR1.25, HX1.25, HXL1.25]
- Torque Wrench [TWR] and Torque Wrench Hex Driver [TW1.25, TW1.25L]

For additional information, refer to the Instructions for Use located at <https://labeling.zimmerbiomet.com>.



Aligning the Internal Hex

During placement, orient the flat of the pre-attached Fixture Mount/Transfer toward the buccal/labial surface. This ensures that the flat of the internal hex is in the correct orientation.

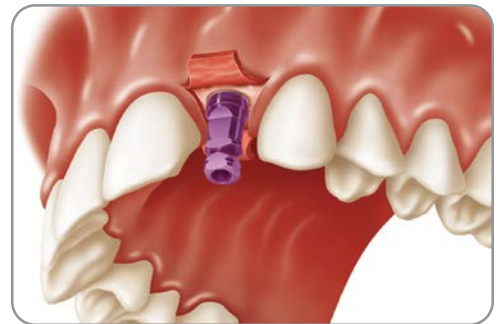

Delivery the Healing Component

Place a healing collar or provisional restoration in a single-stage procedure for soft-tissue contouring.

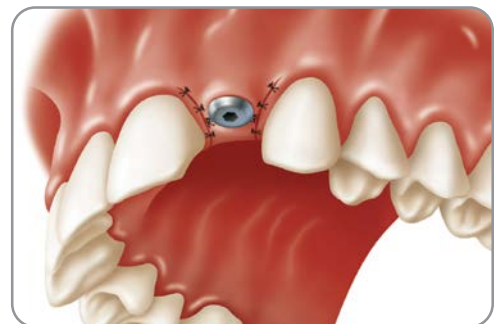

Cement-Retained Restorations

Taking an Impression

Use a light to medium-body material around the transfer and record a full-arch impression with medium-body material. Remove the transfer from the implant after the impression has been taken.

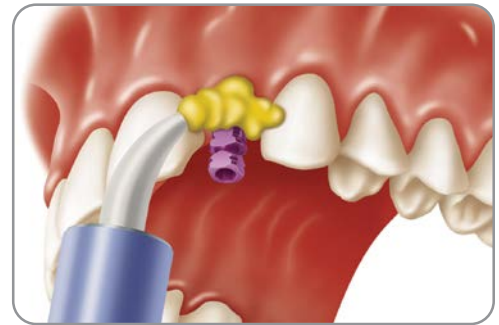

Attaching the Analog

Attach an Implant Analog to the transfer with the 1.25 mmD Hex Tool [HXGR1.25, HXLGR1.25, HX1.25, HXL1.25] and re-insert into the impression. Send the impression to the laboratory.

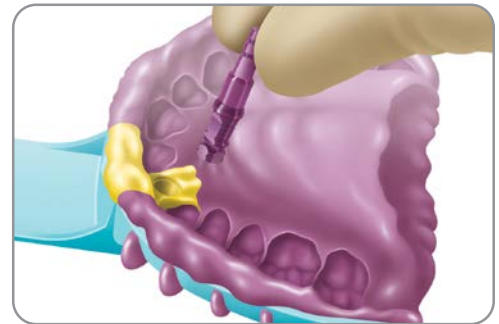

Selecting the Abutment

Pour the cast in die stone. Use soft-tissue material to represent gingival contours. Use the Contour Abutment Try-ins to help select the appropriate angle and cuff height of the final abutment.

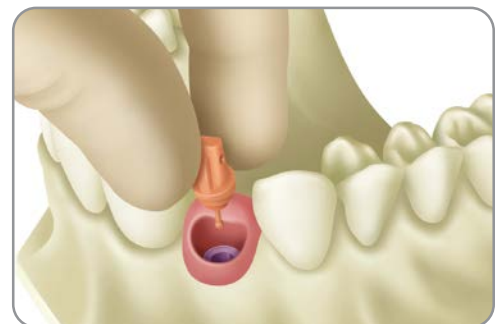

Marking the Abutment Height

Mark the Contour Zirconia Abutment for required modifications to achieve appropriate vertical clearance as well as gingival contours.



Planning Abutment Reduction

Prepare the Zirconia abutment according to the Instructions for Use.
Do not reduce the coronal wall of the 3.5 mmD Zirconia abutment.

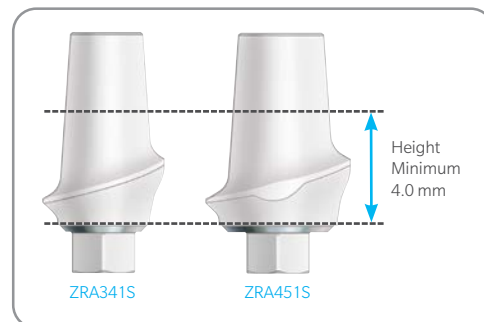

Modifying Abutment Height

Modify the abutment with burs specifically designed for use with zirconia.
Preparation with water is highly recommended.

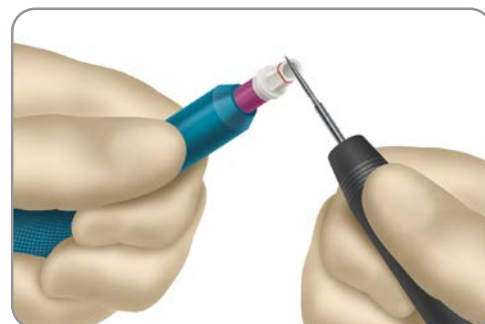

Preparing the Coping

Prepare the coping using traditional prosthodontic techniques.



Finishing the Final Prosthesis

Complete the final restoration according to traditional laboratory procedures.



Cement-Retained Restorations

Seating the Abutment

Place the Zirconia abutment and tighten the retaining screw to 30 Ncm with a calibrated prosthetic Torque Wrench [TWR].



Delivering the Final Prosthesis

Block out the screw access channel in the abutment and cement the final prosthesis to complete the restoration.



Hex-Lock Contour Abutment System

Considerations:

- Used as a terminal or intermediate abutment for a cemented prosthesis
- Used for single- or multiple-unit restorations
- Angled: Used where the angle needs to be offset by 17° Abutment
- Contour Abutment Restorative System for snap-on impression taking and immediate provisionalization
- Abutment cone is 6.25 mm in height above the buccal margin and 4.75 mm above the lingual margin with an 8° taper (4° on each side)
- Predefined margins 1.5 mm higher on the lingual aspect mimic the soft-tissue profile
- Not to be used as “cast-to” abutments
- Angled: Not for use with implants requiring greater than 25° of correction to long axis
- Facilitates One Abutment-One Time™ protocol

Specifications:

- Platform Sizes: 3.5 mm, 4.5 mm, 5.7 mm
- Emergence Profiles: 4.5 mm, 5.5 mm, 6.5 mm
- Cuff Heights (lingual): 1.0 mm, 2.0 mm, 3.0 mm (Straight) and 1.0 mm, 2.0 mm (Angled)

Instrumentation Needed:

- 1.25 mmD Hex Tool [HXGR1.25, HXLGR1.25, HX1.25, HXL1.25]
- Torque Wrench [TWR] and Torque Wrench Hex Driver [TW1.25, TW1.25L]
- Friction-Fit Removal Tool [TLRT2]
- Abutment Holder [ABTH]

For additional information, refer to the Instructions for Use located at <https://labeling.zimmerbiomet.com>.

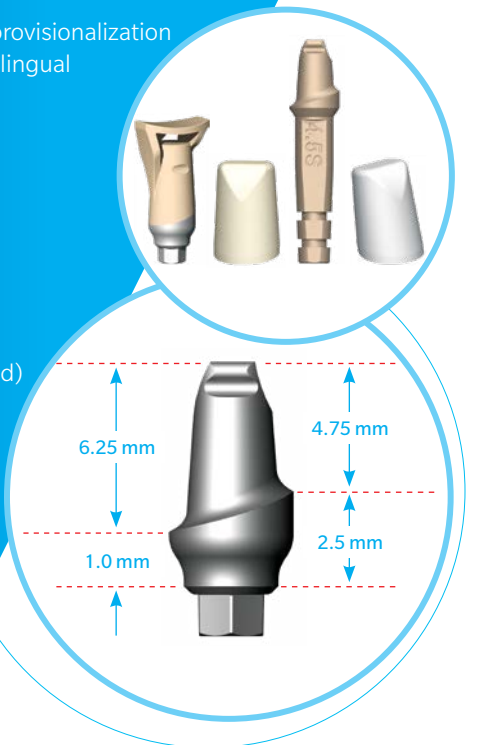

Exposing the Top of the Implant

Remove the Surgical Cover Screw or Healing Collar from the implant using a 1.25 mmD Hex Tool [HXGR1.25, HXLGR1.25].



Selecting and Seating Hex-Lock Contour Abutment

Hex-Lock Contour Abutments consist of an abutment body with prepared margins and an abutment screw. Contour abutments are available in straight and 17° angled versions in a variety of cuff heights and emergence profiles for various tooth locations. To seat the abutment, interdigitate the abutment's hex with the hex of the implant, orienting the short side of the cuff to the buccal aspect. Tighten the abutment screw to 30 Ncm with a calibrated prosthetic Torque Wrench [TWR] to ensure a friction-fit connection with the implant is obtained. Verify with an x-ray that the abutment is fully seated.

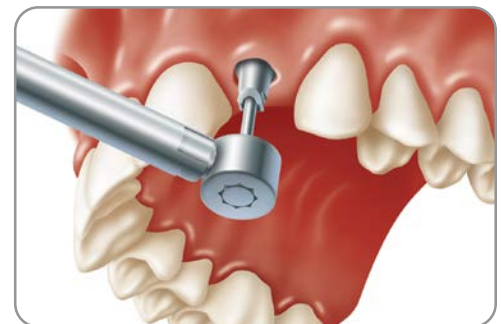

Cement-Retained Restorations

Making the Abutment-Level Impression

Place the impression cap over the abutment, making sure the cap is aligned with the contours of the margin. The long flat on the buccal aspect of the impression cap may be used as a reference for positioning the cap properly. Snap cap into place.

NOTE: If modifications to the Contour Abutment are necessary, do not use the Contour Impression Cap. A direct technique (traditional crown and bridge impression), ensuring complete exposure of the modified margin, or an indirect impression utilizing an implant-level impression post and analog must be used if the abutment margins have been adjusted.



Completing the Impression Procedure

An elastomeric impression material, such as vinyl polysiloxane or polyether should be used. A light-bodied material may be injected around the impression cap as in the utilization of a “wash” technique. Fill the tray with medium- to heavy-bodied impression material in preparation for a full-arch impression. Place the loaded tray into the patient’s mouth and allow the impression material to set according to the manufacturer’s recommendations. Remove the tray from the mouth. The Contour Impression Cap will be retained in the impression material. Take an impression of the opposing arch and record bite.

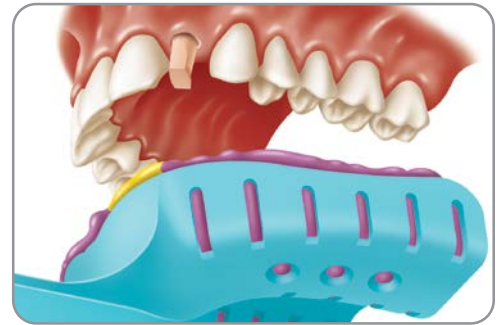

Fabricating and Cementing the Provisional Prosthesis

Prepare the provisional crown by applying acrylic to the Contour Provisional Coping according to traditional prosthodontic techniques. Block out the screw access hole and cement the provisional prosthesis onto the Hex-Lock Contour Abutment with soft-access cement. Alternatively, use the provisional coping as a base for the fitting of a pre-fabricated shell crown as the temporary restoration.



Attaching the Contour Abutment Analog

Align the Contour Abutment Analog with the corresponding color-coded Contour Impression Cap in the impression and snap the analog into place. The abutment analog will replicate the Hex-Lock Contour Abutment in the stone model.

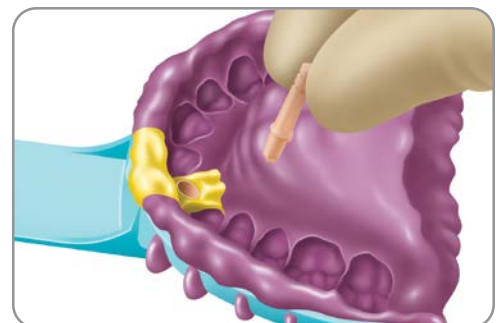

Pouring the Working Cast

Using soft-tissue material to represent gingival contours, pour the model in die stone. Utilize interocclusal bite registration to articulate the working cast with the opposing model.



Utilizing the Contour Waxing Coping

Place the Contour Waxing Coping on the abutment analog in the model, aligning the coping with the contours of the margin. Use wax, resin or other waxing materials to seal the margin area.



Fabricating the Wax Coping

Create the wax coping according to traditional crown and bridge procedures. Attach a 10-gauge sprue with reservoir to the thickest part of the wax coping. Add an auxiliary sprue and vent as needed.



Casting the Wax Pattern

Follow traditional techniques to cast and finish the wax-up coping or metal frame. Send it to the clinician for a patient try-in. The dentist should confirm fit and marginal integrity before the veneering material is applied.

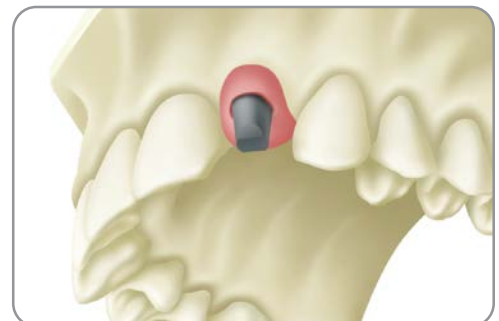

Cement-Retained Restorations

Finishing the Final Prosthesis

Apply the veneering material to the metal coping according to routine laboratory procedures. Send the finished restoration to the clinician for final delivery.



Delivering the Final Prosthesis

Remove the provisional restoration and any remaining cement from the abutment. Retorque the abutment to 30 Ncm with a calibrated Torque Wrench [TWR]. Seal the screw access channel in the abutment with a cotton pellet, light-curing resilient material or gutta-percha. This will ensure future access to the screw head. Seat the final prosthesis onto the abutments and confirm fit, contour and marginal integrity. Check the bite for function and occlusion. Cement the final prosthesis with a cement of choice. To facilitate future retrievability, a soft-access or temporary cement may be used. Provide the patient with oral hygiene instructions prior to release.

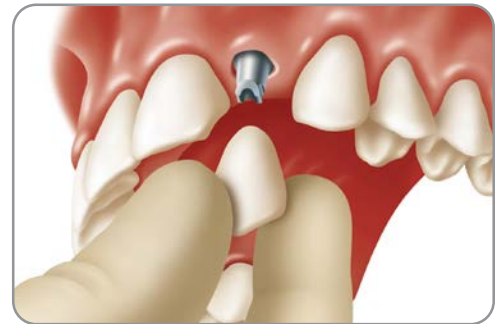

Hex-Lock Short Abutment System

Considerations:

- Used as a terminal or intermediate abutment for a cemented prosthesis
- Used for a single- or multiple-unit restoration
- 4 mm profile abutment cone designed for the limited interocclusal space of the posterior
- Predetermined margins to reduce or eliminate preparation
- Short Abutment Restorative System for snap-on impression taking and immediate provisionalization
- Not to be used as “cast-to” abutments

Specifications:

- Platform Sizes: 3.5 mm, 4.5 mm, 5.7 mm
- Emergence Profiles: 4.5 mm, 5.5 mm, 6.5 mm
- Cuff Heights: 1.0 mm, 2.0 mm

Instrumentation Needed:

- 1.25 mmD Hex Tool [HXGR1.25, HXLGR1.25, HX1.25, HXL1.25]
- Torque Wrench [TWR] and Torque Wrench Hex Driver [TW1.25, TW1.25L]
- Friction-Fit Removal Tool [TLRT2]
- Abutment Holder [ABTH]

For additional information, refer to the Instructions for Use located at <https://labeling.zimmerbiomet.com>.



Exposing the Top of the Implant

Conventional protocol (shown): Remove Healing Collar from implant using the 1.25 mmD Hex Tool [HXGR1.25, HXLGR1.25]. One Abutment-One Time protocol: Hex-Lock Short Abutment is placed immediately after implant placement or uncovering, when clinically appropriate, eliminating the healing collar.



Selecting and Seating the Hex-Lock Short Abutment

Seat the Hex-Lock Short Abutment onto the implant. Tighten the screw to 30 Ncm with a calibrated prosthetic Torque Wrench [TWR]. Verify with x-rays that the abutment is fully seated.

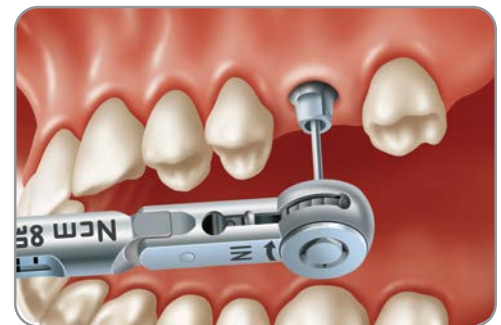

Cement-Retained Restorations

Making an Abutment-Level Impression

Place the Short Impression Cap over the abutment. Snap the cap into place. If modifications to the abutment are needed, the impression cap should not be used.



Completing the Impression Procedure

Syringe impression material around the impression cap and record a full-arch impression. The cap will be picked up in the impression.

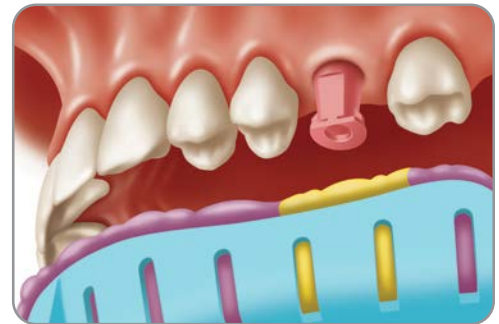

Attaching the Short Abutment

Align the Short Abutment Analog with the impression cap, using the flat on the analog to align with the flat on the inside of the impression cap. Insert the analog into the impression and snap into the impression cap.

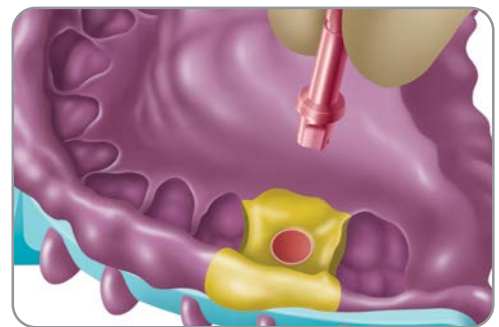

Preparing and Seating the Provisional Prosthesis

Prepare the provisional crown by applying acrylic to the Short Provisional Coping or use the coping alone. Block out the screw channel and cement the crown or cap in place using provisional cement.

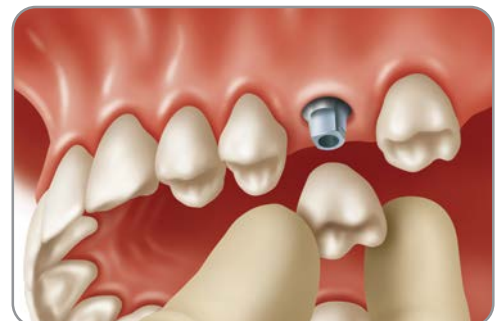

Pouring the Working Cast

In the laboratory, pour the model in die stone using soft-tissue material to represent gingival contours.

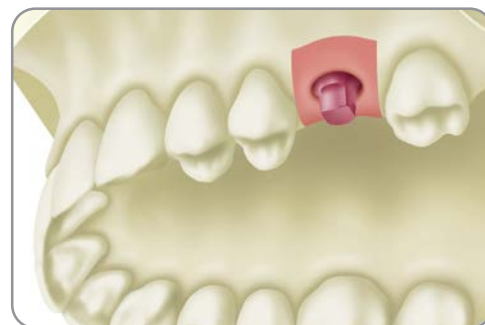

Utilizing the Short Waxing Coping

Place the Short Waxing Coping on the abutment analog in the master cast. Use the flat on the analog to align with the flat on the coping.

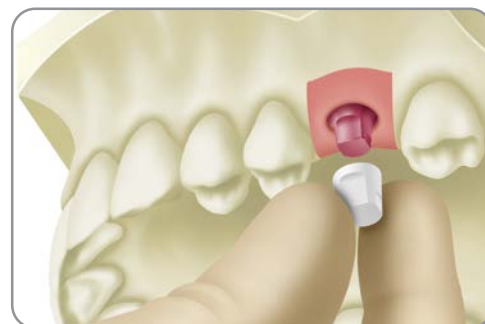

Fabricating the Wax Coping

Seal the margins of the Short Waxing Coping. Wax and cast the coping using traditional prosthodontic techniques.

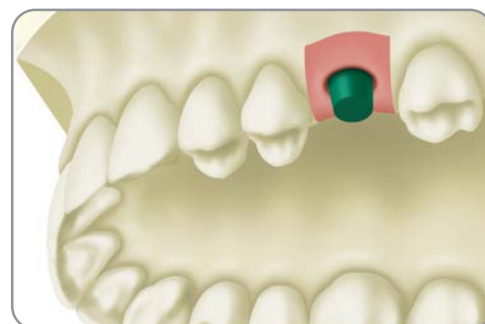

Casting the Wax Pattern

Apply porcelain to the casting to complete restoration.

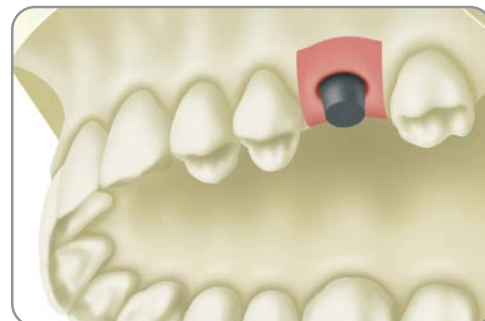

Cement-Retained Restorations

Removing the Provisional Crown

Remove the provisional crown. Clean off any remaining cement. Block out the screw channel. Cement the final crown.



Delivering the Final Restoration

Completed restoration in place.

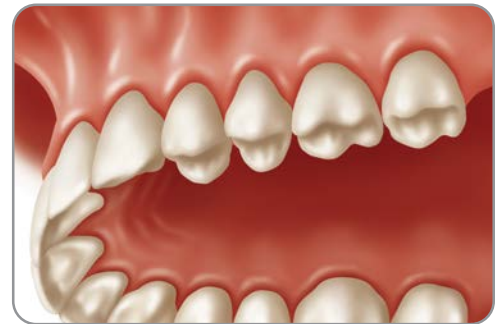

Hex-Lock Abutments

Considerations:

- Use as a terminal or intermediate abutment for cemented prosthesis
- Abutments must be parallel within 7° or prepped to be parallel
- Used for single tooth or splinted to other abutments
- Full-contour, preparable abutment base can be modified to create a variety of contoured margins and abutment profiles
- Maximum preparation is 1 mm below the abutment score line of 4.7 mm, when using the [MHLAS screw
- Not for screw-retained prosthetics
- Not for use in conditions where less than 3.7 mm vertical height remaining after reduction, or when parallelism by prepping cannot be achieved
- When using [MHLAS] screw included with the abutment
- Do not prepare below the abutment score line of 4.7 mm, when using the [HLTS2] screw

Specifications:

- Platform Sizes: 3.5 mm, 4.5 mm, 5.7 mm
- Emergence Profiles: 3.5 mm, 4.5 mm, 5.5 mm, 6.5 mm

Instrumentation Needed:

- 1.25 mmD Hex Tool [HXGR1.25, HXLGR1.25]
- Torque Wrench [TWR] and Torque Wrench Hex Driver [TW1.25, TW1.25L]
- Friction-Fit Removal Tool [TLRT2]
- Abutment Holder [ABTH]

For additional information, refer to the Instructions for Use located at <https://labeling.zimmerbiomet.com>.

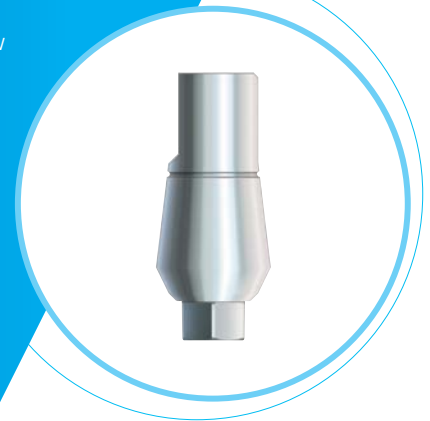

Selecting the Hex-Lock Abutments

Fabricate the working cast utilizing one of the transfer procedures mentioned in the previous section. Hex-Lock Abutments (“abutment”) consist of an abutment body and an abutment screw. Abutments and corresponding transfers are available in a variety of diameters and flares designated for specific tooth locations. NOTE: The abutment should have the same profile as the Healing Collar and Direct or Indirect Transfer.



Seating the Hex-Lock Abutments

Interdigitate the abutment’s hex with the hex of the Implant Analog in the working cast (or implant in the patient’s mouth) and place the abutment onto the Implant Analog (or implant). Thread the abutment screw through the abutment body and into the Implant Analog (or implant) with the Hex Tool [HXGR1.25, HXLGR1.25, HX1.25, HXL1.25]. To complete seating and create a friction-fit connection, tighten the abutment screw to 30 Ncm with a calibrated Torque Wrench [TWR].



Cement-Retained Restorations

Determining Hex-Lock Abutment Modifications

Hex-Lock Abutments extend 8.7 mm vertically above the implant/abutment interface. Visually determine the modifications necessary for establishing marginal and vertical contours. The abutments have one score line placed 4.7 mm above the top of the implant. When using the [MHLAS] Screw (included with the abutment), the maximum preparation on the abutment is 1.0 mm below this line [Fig. B]. If using the taller [HLTS2] Screw (sold separately), do not prepare the abutment below the score line in order to preserve adequate hex engagement within the screw [Fig. A].

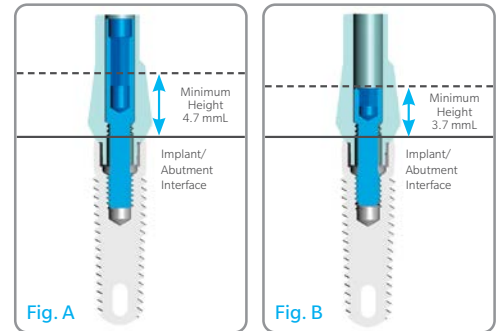
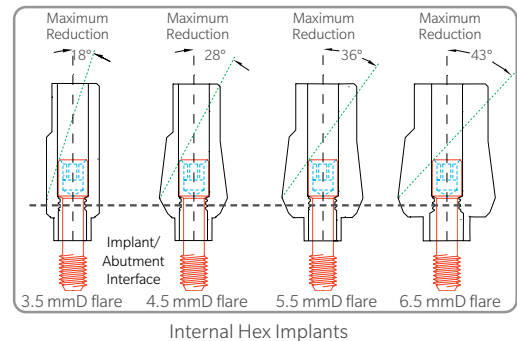

Fig. A
Hex-Lock Abutment with optional Abutment Screw [HLTS2].

Fig. B
Hex-Lock Abutment with standard Abutment Screw [MHLAS].

Preparing Abutments to Maximum Angle

Hex-Lock Abutments can be prepared at an angle to achieve mutual parallelism and to create a favorable path of draw for the prosthesis. When these components are used with the standard Abutment Screws [MHLAS], the maximum angles of correction shown on the left can be achieved.



Internal Hex Implants

Marking the Abutment for Desired Preparation

Mark the required modifications to achieve appropriate vertical clearance as well as gingival contours.

NOTE: The reduction of the abutment needs to take into consideration the following:

- Type of restoration (for example, a ceramic or metal margin).
- Desired thickness of alloy.
- Desired thickness of veneering material.
- Occlusal considerations: centric occlusion, protrusive or lateral excursion.

Use the Hex Tool [HXGR1.25, HXLGR1.25, HX1.25, HXL1.25] to loosen and remove the abutment screw. Thread the Removal Tool [TLRT2] through the access channel in the abutment and rotate in a clockwise direction. Continued rotation of the tool will result in the abutment lifting off the implant.

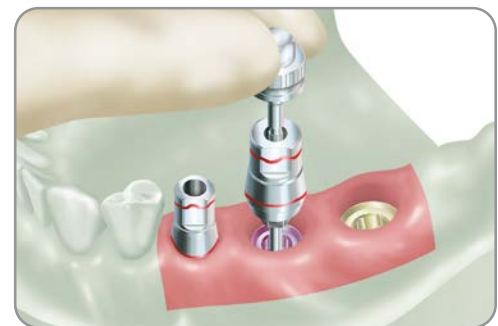

Modifying the Hex-Lock Abutments

Attach the abutment to an additional Implant Analog located within the Abutment Holder [ABTH]. Modify the abutment with cut-off disks, heat less stone wheels and 12-fluted carbide burs. Use a diamond bur to define the margins. Create a dimple on the buccal surface to help orient the abutment on the implant. Preserve or redefine a flat surface as an anti-rotational feature. If modifying the abutments chairside, proceed to placing the prepared abutments.



Fabricating the Provisional Prosthesis

Replace the abutments on the working cast and make final adjustments. Take care not to damage the soft-tissue material, which can be removed from the working cast, if necessary. If a diagnostic wax-up was made, make an alginate impression over it and pour the impression in dental stone. Mold a clear acrylic sheet onto the cast of the diagnostic wax-up according to the manufacturer's instructions. Remove the mold from the cast. Occlude screw access holes and lubricate the abutments and working cast and then flow temporary material into the areas of the abutments and missing teeth in the mold. Seat the mold onto the cast containing the prepared abutments. Trim the resulting provisional prosthesis and return it with the prepared abutments to the dentist.



Placing the Prepared Abutments

Sterilize the prepared abutments before replacing them into the patient's mouth. Interdigitate the hexes of each abutment and implant utilizing the dimple to orient the abutment in the correct spatial position. Thread the abutment screw through the abutment body and into the implant with the Hex Tool [HXGR1.25, HXLGR1.25, HX1.25, HXL1.25]. Tighten each abutment screw to 30 Ncm with a calibrated Torque Wrench [TWR].



Making Final Adjustments to the Abutments

With a round-end, 12-fluted carbide bur in a high-speed handpiece, make minor modifications to the gingival and vertical contours of the abutments under copious irrigation. After completing final modifications, retighten the abutment screws to the recommended torque. Take a radiograph to confirm that the abutments are fully seated.



Cement-Retained Restorations

Making an Impression of the Prepared Abutments

Block out the hex holes in the tops of the abutment screws with a medium of choice to prevent the ingress of impression material. Remove excess material so that the block-out is flush with the ends of the abutment screws. Make a conventional, full-arch, crown and bridge impression with an elastomeric impression material, such as vinyl polysiloxane. To insure a proper fit of the finished restoration, the abutments must remain in the patient's mouth after completing the impression procedure. Send the impression to the laboratory to fabricate a porcelain-fused-to-metal bridge.

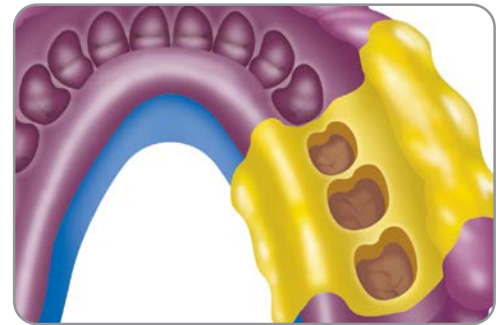

Cementing the Provisional Prosthesis

Block out the hex holes in the tops of the abutment screws with material of choice. If the laboratory has fabricated a provisional prosthesis, cement it onto the prepared abutments with soft-access cement. If a provisional prosthesis has not been fabricated, block out any undercuts and lightly lubricate the abutments. Fabricate a prosthesis over the abutments chairside with a light-cure or autopolymerizing tooth-colored acrylic material. For a more dense cure, remove the set provisional prosthesis from the mouth and place it in a curing unit. After curing, remove the restoration from the mold, trim and polish, then cement the finished provisional prosthesis onto the abutments.



Pouring the Working Cast

Pour the standard crown and bridge impression in die stone. An epoxy die material may be useful if preparations are extremely thin. Separate the cast from the impression. Follow standard laboratory procedures to produce a soft-tissue model. Utilize the interocclusal records to articulate the working cast with the opposing-arch cast. Prepare the working cast to fabricate the wax framework pattern.

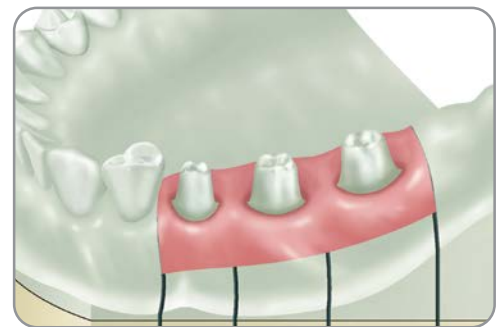

Fabricating the Wax Framework Pattern

Create the wax framework pattern according to routine crown and bridge procedures.

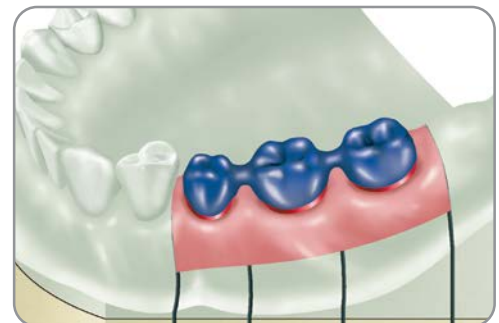

Spruing, Investing and Casting the Framework Pattern

Attach 10-gauge sprue wax with reservoirs to the thickest part of each unit within the framework pattern. Add auxiliary sprues and vents to prevent porosity in the casting as needed.

Invest and cast the pattern in noble or high noble ceramic alloy according to the manufacturer's guidelines.



Finishing the Cast Framework

Divest the cast framework with ultrasonic cleaning and non-abrasive glass bead. Follow conventional laboratory techniques to fit and finish the cast framework. Seat the finished framework onto the working cast and confirm that a passive fit has been achieved. Place the framework on the working cast and send it to the clinician for a try-in of the metal framework. The dentist should confirm that a passive fit has been achieved before the veneering material is applied.



Trying in the Finished Framework

Remove the provisional restoration from the patient's mouth. Retorque the abutment screws to 30 Ncm with a calibrated Torque Wrench [TWR]. Seat the finished framework onto the abutments. Verify that it fits passively, and that no additional finishing or adjustment is required. Remove the framework. Reseat the provisional prosthesis with soft-access cement.

Return the framework to the laboratory on the working cast for completion of the fixed partial denture.



Applying the Porcelain (Veneering Material)

Prepare the framework to receive the opaque layer according to routine laboratory procedures.



Cement-Retained Restorations

Finishing the Final Prosthesis

Apply porcelain to the framework according to routine laboratory procedures. Finish the porcelain and polish any metal margins, seat the finished prosthesis on the working cast and send it to the clinician for final delivery.



Delivering the Final Prosthesis

Remove the provisional restoration from the patient's mouth. Retorque the abutments to 30 Ncm with the calibrated Torque Wrench [TWR]. Wait ten minutes, then retighten. This is done to compensate for clamping force lost due to screw embedment. Seal the screw access channel in each abutment with cotton pellets and light-curing resilient material or gutta-percha. This will ensure future access to the screw head. Seat the final prosthesis onto the abutments and confirm fit and contour. Check the occlusion. Verify that no additional finishing or adjustment is required. Cement the final prosthesis with a cement of choice. To facilitate future retrievability, a soft-access cement may be used. Provide the patient with oral hygiene instructions prior to release.



Hex-Lock Angled Abutments

Considerations:

- Use as a terminal or intermediate abutment for cemented prosthetics when long axis of the abutment needs to be changed by 20°
- Used for single-tooth or splinted restorations
- Preparable to follow gingival contours
- 0.50 mm subgingival soft-tissue thickness is required for aesthetic emergence
- Minimum vertical clearance between the implant interface and opposing dentition is 2.85 mm as measured from the top of the implant to the top of the abutment screw. This measurement is also the maximum reduction height although requirements for cement retention may be higher

Specifications:

- Platform Sizes: 3.5 mm, 4.5 mm, 5.7 mm
- Emergence Profiles: 4.5 mm, 5.5 mm, 6.5 mm

Instrumentation Needed:

- 1.25 mmD Hex Tool [HXGR1.25, HXLGR1.25, HX1.25, HXL1.25]
- Torque Wrench [TWR] and Torque Wrench Hex Driver [TW1.25, TW1.25L]
- Friction-Fit Removal Tool [TLRT2]
- Abutment Holder [ABTH]

For additional information, refer to the Instructions for Use located at <https://labeling.zimmerbiomet.com>.

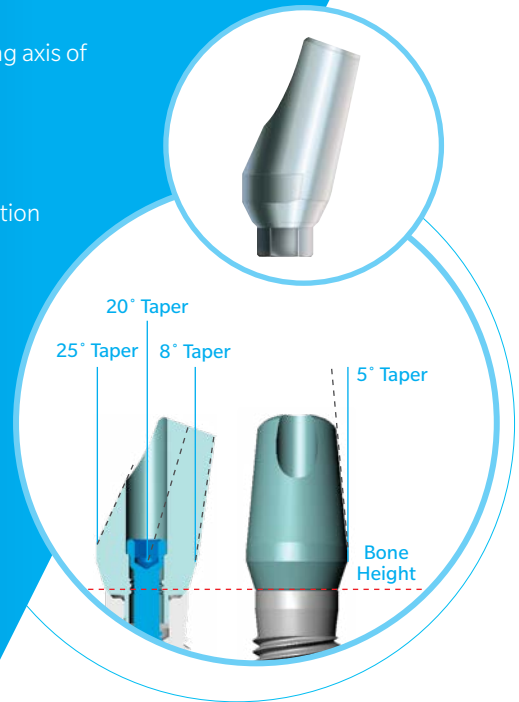

Exposing the Top of the Implant

- Remove the Healing Collar with the 1.25 mmD Hex Tool [HXGR1.25, HXLGR1.25].

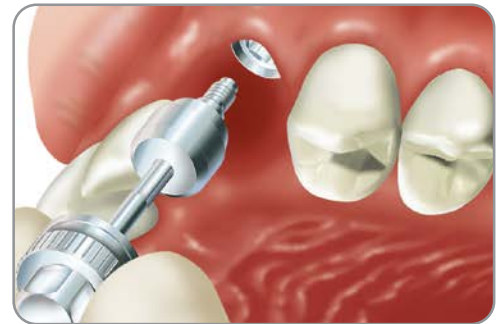

Selecting the Angled Abutment

When the hex of the implant is oriented at the time of surgery so that the flat surface of one side of the hexagon of the implant is toward the direction of the implant angulation, the Angled Abutment helps to facilitate a restoration when the long axis of the implant is approximately 15 to 30 degrees out of parallelism with the clinical long axis of the adjacent teeth.

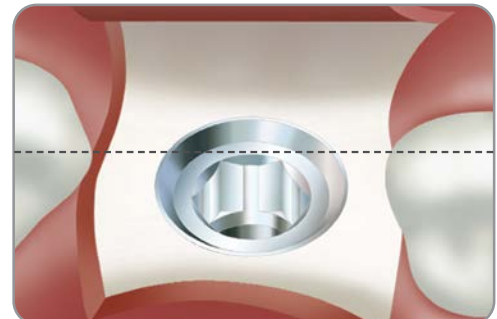

Cement-Retained Restorations

Initially Seating the Angled Abutment

Select the Angled Abutment corresponding to the dimensions of the implant platform being restored.

Remove the abutment from the packaging. Use the 1.25 mmD Hex Tool [HXGR1.25, HXLGR1.25, HX1.25, HXL1.25] to remove the abutment screw to allow for easy placement and alignment of the abutment. Carry the component to the implant (analog), interdigitate and press-fit the abutment's hex to the implant's (analog) hex.

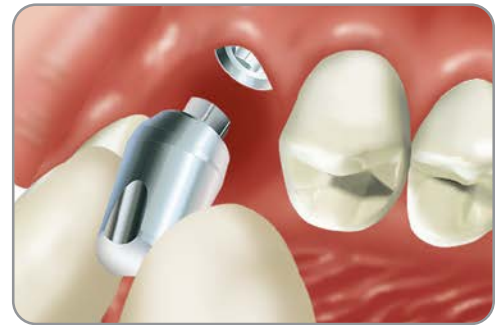

Seating the Angled Abutment

Thread the abutment screw through the access channel within the abutment using the 1.25 mmD Hex Tool [HXGR1.25, HXLGR1.25, HX1.25, HXL1.25]. Tighten the abutment screw to 30 Ncm with a calibrated Torque Wrench [TWR].

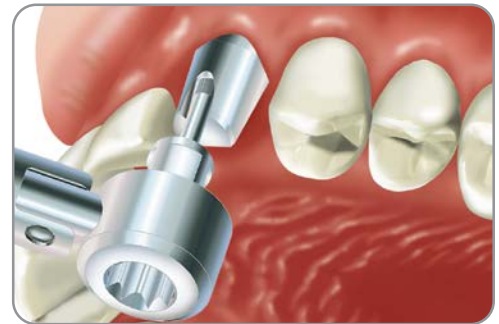

Marking the Abutment for Desired Preparation

Mark the required modifications to achieve appropriate vertical clearance as well as gingival contours.

NOTE: The reduction of the abutment needs to take into consideration the following:

- Type of restoration (for example, a ceramic or metal margin).
- Desired thickness of alloy.
- Desired thickness of veneering material.
- Occlusal considerations such as centric occlusion, protrusive or lateral excursions.

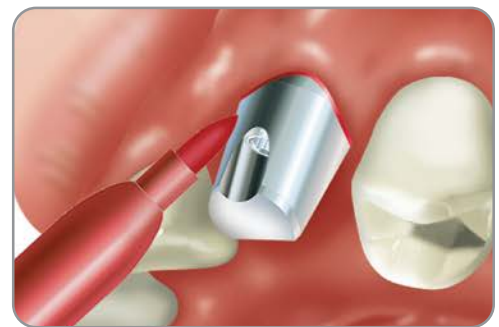

Removing the Abutment

Use the 1.25 mmD Hex Tool [HXGR1.25, HXLGR1.25, HX1.25, HXL1.25] to loosen and remove the abutment screw. Thread the Removal Tool [TLRT2] through the access channel in the abutment and rotate in a clockwise direction. Continued rotation of the tool will result in the abutment lifting off the implant.



Modifying the Angled Abutments

Attach the abutment to an additional Implant Analog located within the Abutment Holder [ABTH]. Modify the abutment with cut-off disks, heatless stone wheels and 12-fluted carbide burs. Use a diamond bur to define the margins. Create a dimple on the buccal surface to help orient the abutment on the implant. Preserve or redefine a flat surface as an anti-rotational feature.



Making Final Adjustments to the Abutments

With a round-end, 12-fluted carbide bur in a high-speed handpiece, make minor modifications to the gingival and vertical contours of the abutments under copious irrigation. After completing final modifications, retighten the abutment screws to the recommended torque. Take a radiograph to confirm that the abutments are fully seated.



Making an Impression of the Prepared Abutment

Block out the screw access channel in the top of the abutment with a medium of choice to prevent the ingress of impression material. Remove excess material so that the block-out is flush with the contour of the abutment. Failure to do so may prevent an accurate impression procedure. Make a conventional, full-arch, crown and bridge impression with an elastomeric impression material, such as vinyl polysiloxane. To insure a proper fit of the finished restoration, the abutment must remain in the patient's mouth after completing the impression procedure. Send the impression to the laboratory to fabricate a porcelain-fused-to-metal prosthesis.

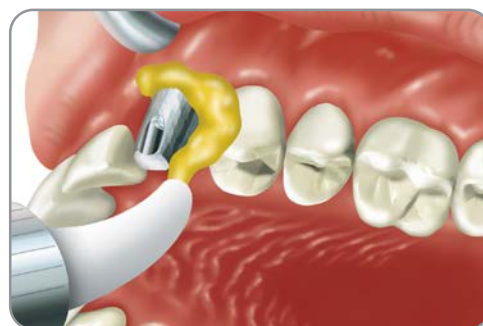

Fabricating the Provisional Prosthesis

If a diagnostic wax-up was made, make an alginate impression over it and pour the impression in dental stone. Mold a clear acrylic sheet onto the duplicate cast of the diagnostic wax-up according to the manufacturer's instructions. Remove the mold from the cast and flow temporary material into the area of the abutment and edentulous space. Lubricate the prepared abutment and then seat the mold onto the abutment in the patient's mouth. After the material sets, remove it from the mouth and trim and polish the resulting provisional prosthesis.



Cement-Retained Restorations

Cementing the Provisional Prosthesis

Block out the hex hole in the tops of the abutment screw with material of choice. Cement the provisional prosthesis onto the prepared abutment with soft-access cement. Alternatively, lightly lubricate the abutment and fabricate a provisional prosthesis over the abutment chairside with light-curing material. Once the material is cured, remove the provisional restoration from the patient's mouth, trim and polish it prior to cementation of the finished provisional prosthesis onto the abutment.



Pouring the Working Cast

Pour the standard crown and bridge impression in die stone. An epoxy die may be useful with an extremely thin preparation. Separate the cast from the impression. Use the interocclusal records to articulate the working cast with the opposing-arch cast. Prepare the working cast for fabrication of the wax framework pattern.

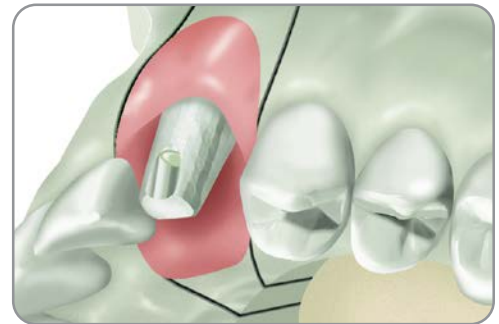

Fabricating the Wax Framework Pattern

Create the wax framework pattern according to standard crown and bridge procedures.



Spruing, Investing and Casting the Framework Pattern

Attach 10-gauge sprue wax with reservoir to the thickest part of the framework pattern. Add an auxiliary sprue and vent to prevent porosity in the casting as needed.

Invest and cast the pattern in noble or high noble ceramic alloy according to the manufacturer's guidelines.



Finishing the Cast Framework

Divest the cast framework with ultrasonic cleaning and non-abrasive glass bead. Remove the soft-tissue replica from the working cast and follow routine laboratory procedures to fit and finish the framework. Seat the finished framework onto the working cast.

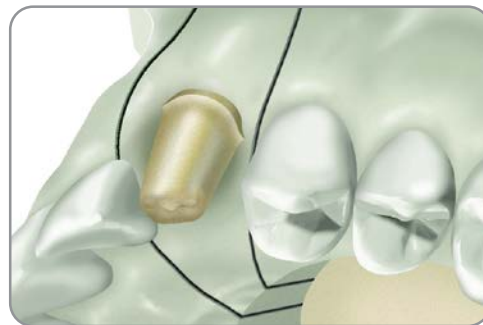

Applying the Porcelain (Veneering Material)

Prepare the framework to receive the opaque layer according to routine laboratory procedures.



Finishing the Final Prosthesis

Apply porcelain to the framework, finish the porcelain, and polish any metal margins according to routine laboratory procedures. Seat the finished prosthesis on the working cast and send it to the clinician for final delivery.



Delivering the Final Prosthesis

Remove the provisional restoration from the patient's mouth. Retorque the abutment screw to 30 Ncm with a calibrated Torque Wrench [TWR].



Delivering the Final Prosthesis

Seal the screw access channel in the abutment with cotton pellets and light-curing resilient material or gutta-percha. This will ensure easy access to the screw head. Seat the final prosthesis onto the abutment and confirm fit and contour. Check the occlusion. Verify that no additional finishing or adjustment is required.

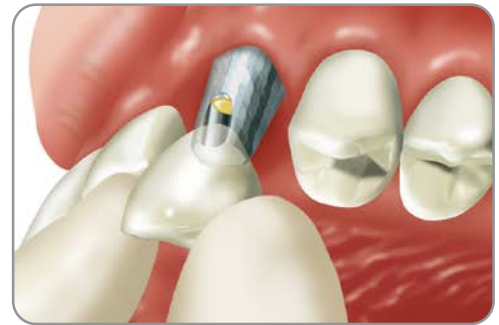

Delivering the Final Prosthesis

Cement the final prosthesis with cement of choice. To facilitate future retrievability, a soft-access cement may be used. Provide the patient with oral hygiene instructions prior to release.

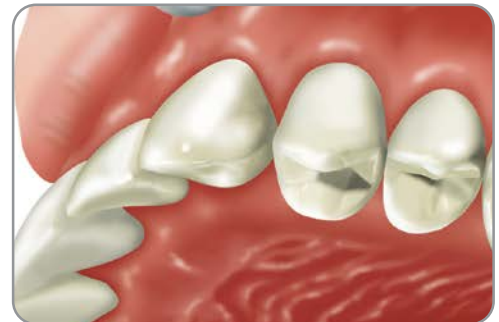

Custom “Cast-To” Restorations

“Cast-To” Gold Abutments, Engaging

Considerations:

- For use when screw retention of a single tooth is desired engaging the prosthesis directly to the implant body
- Used for subgingival margins, when minimum interocclusal space is available, when the soft-tissue thickness is minimal and for custom casting of an angled abutment
- Minimum vertical clearance between the implant interface and the opposing dentition is 3.75 mmL and 3.5 mmL, respectively
- Maximum reduction height is 3.75 mm above the implant interface
- Not for use with cemented prosthesis unless a custom abutment is fabricated
- Not for use with non-precious metal alloys
- Not for use in multiple splinted prosthetics when more than one gold base is involved
- Porcelain cannot be bonded directly to the gold base portion of the component

Specifications:

- Platform Sizes: 3.5 mm, 4.5 mm, 5.7 mm

Instrumentation Needed:

- 1.25 mmD Hex Tool [HXGR1.25, HXLGR1.25, HX1.25, HXL1.25]
- Torque Wrench [TWR] and Torque Wrench Hex Driver [TW1.25, TW1.25L]
- Friction-Fit Removal Tool [TLRT2]

For additional information, refer to the Instructions for Use located at <https://labeling.zimmerbiomet.com>.

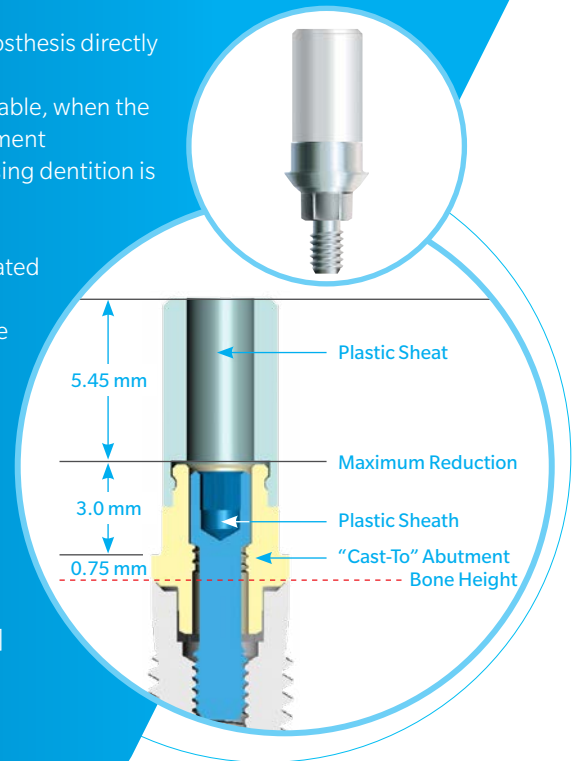

Selecting the “Cast-To” Gold Abutment

Fabricate the working cast utilizing one of the transfer procedures mentioned in the previous section. “Cast-To” Gold Abutments for internal hex [HLA3G, HLA4G, and HLA5G] implants consist of a hexed, gold “Cast-To” Abutment body, abutment screw and 3.8 mmD press-fit Plastic Sheath [OPS].

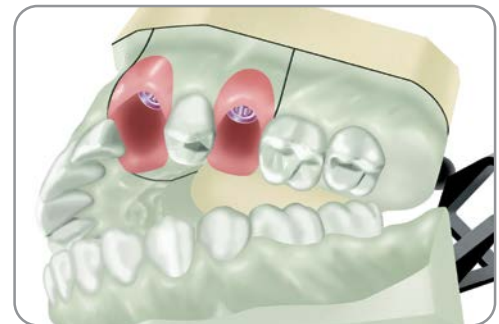

Attaching the Abutments and Plastic Sheaths

Carefully seat the assemblies onto the Implant Analogs in the working cast. Thread the abutment screws through the abutment assemblies and into the Implant Analogs with the 1.25 mmD Hex Tool [HXGR1.25, HXLGR1.25, HX1.25, HXL1.25]. To fully seat the friction-fit abutments, tighten the abutment screws to 30 Ncm with a calibrated Torque Wrench [TWR]. Once seated, utilize the Removal Tool [TLRT2] to retrieve the abutments from the Implant Analogs, as required.

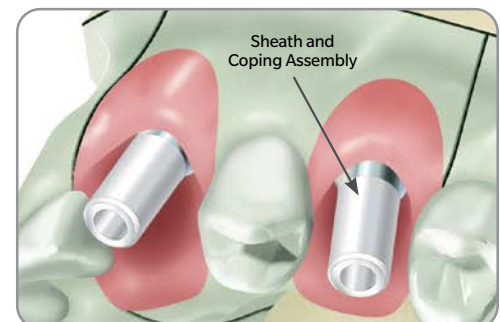

Custom “Cast-To” Restorations

Trimming the Plastic Sheaths

Visually determine the modifications needed to provide adequate clearance for adjacent and opposing dentition. Consult with the clinician to determine any additional modifications needed for the case design. The case illustrated here involves the fabrication of a cast abutment on the canine and a screw-retained, combination abutment-and-crown on the second premolar.

Section the Plastic Sheaths with a cutting disk to obtain the correct vertical and interproximal clearance.



Fabricating the Framework Pattern

Use wax and/or acrylic burnout resin to incorporate the modified gold base and Plastic Sheaths into the pattern. Build up the final contours of the pattern with crown and bridge wax.

As an option to using the Plastic Sheaths and abutment screws:

- Secure the abutments to the Implant Analogs with the Waxing Screws [MTWSD for internal hex implants].
- Lightly lubricate the Waxing Screw.
- Use wax and or acrylic burnout resin and fabricate the framework pattern around the screw and directly to the abutments.

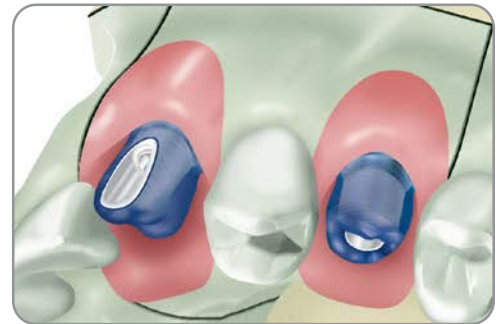

Removing the Framework Pattern

Remove the abutment screw with the 1.25 mmD Hex Tool [HXGR1.25, HXLGR1.25, HX1.25, HXL1.25]. Thread the Removal Tool [TLRT2] through the abutment pattern and into the implant to remove the pattern from the Implant Analog.

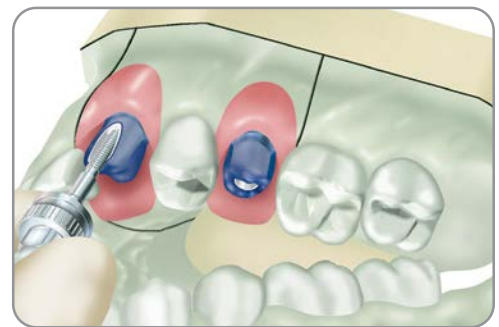

Spruing, Casting and Divesting of the Metal Framework

Attach 10-gauge sprue wax with reservoirs to the thickest part of each unit. Carefully apply a thin layer of wax or burnout resin at the junction of the abutment and the Plastic Sheath to ensure a smooth casting. Add auxiliary sprues and vents to prevent porosity in the casting as needed. Do not use a debubbler when investing the gold or plastic components.

When casting to gold components, the casting alloy must not exceed a casting temperature of 2350°F/1288°C. Cast the framework pattern according to conventional techniques utilizing a two-stage burnout, which is standard practice with patterns containing plastic or resin. The burnout temperature should not exceed 1500°F/815°C, with a hold time of no longer than 1 hour. Utilize high noble or noble alloy with a compatible investment material, as described in the manufacturer's guidelines.

Divest the casting; chemical investment removers may also be used with gold components. To ensure that the fitting surface of the incorporated copings are not damaged, protect the abutment interface while blasting the abutment with glass bead. Clean the casting in an ultrasonic unit.

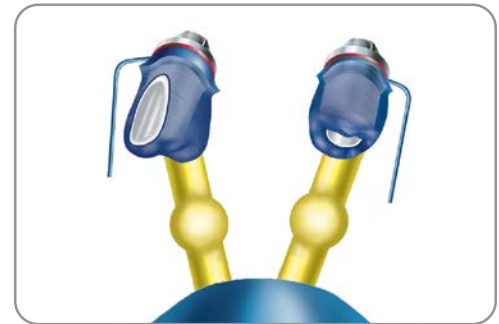
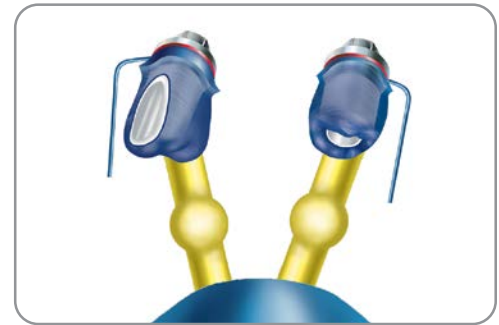

Finishing the Metal Framework

Confirm that a passive fit has been achieved on the corresponding Implant Analog in the working cast. The soft-tissue replica can be removed from the working cast to provide visual access to the cast abutment/implant analog connection, if desired. Use the abutment screws to secure the finished cast metal abutments to the Implant Analogs in the working cast and return it to the clinician for try-in. Make sure the clinician has the appropriate Removal Tool [TLRT2] to disengage the incorporated "Cast-To" Gold Abutments from the working cast.

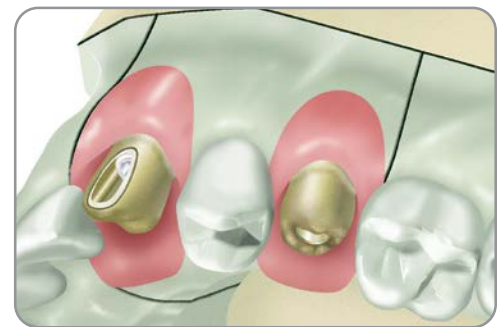

Removing the Healing Components

Unthread the abutment screws with the 1.25 mmD Hex Tool [HXGR1.25, HXLGR1.25, HX1.25, HXL1.25]. Remove the abutments from the working cast with the appropriate removal tool. Clean and sterilize the components according to validated parameters in the product's Instructions for Use.

Remove the provisional restoration from the patient's mouth. Unthread the Healing Collars or Surgical Cover Screws with the 1.25 mmD Hex Tool [HXGR1.25, HXLGR1.25]. Clean and sterilize the components for placement after the cast abutment try-in.

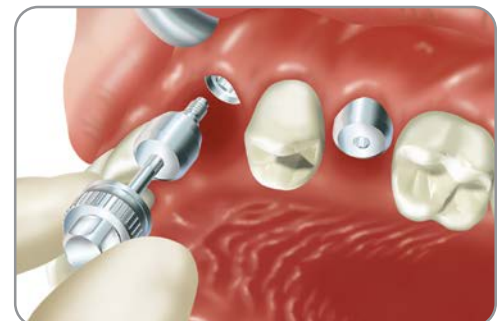

Custom “Cast-To” Restorations

Placing the Cast Abutments

Interdigitate the hex of each cast post with its corresponding implant, then use the 1.25 mmD Hex Tool [HXGR1.25, HXLGR1.25, HX1.25, HXL1.25] to thread the abutment screw through the cast post body and into the implant. Tighten the abutment screw to 30 Ncm with a calibrated Torque Wrench [TWR]. Wait ten minutes, then retighten the cast posts to 30 Ncm. Take a radiograph to verify that the cast posts are completely seated.



Prepare the abutment for fabrication of a porcelain-fused-to-metal restoration. Seal the abutment screw access hole of the cast post with a resilient material. Lubricate the cast post and flow autopolymerizing burnout resin over the contour of the cast post above the proposed restoration finish line. Do not use crown and bridge wax directly on the cast post, as it can pull away from the metal and cause inaccuracies in the final metal coping.

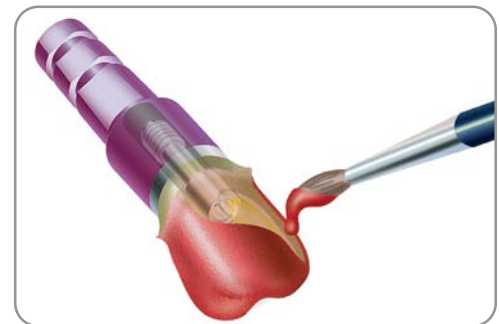

Build up the final contour of the coping with crown and bridge wax. Attach 10-gauge sprue wax to the thickest part of the coping. Invest the coping:

- Option 1: Follow standard setting expansion of the investment material when using a stone die.
- Option 2: Allow for a greater setting expansion of the investment material when using a metal die (abutment). This will compensate for the lack of die spacer used on the abutment when the coping pattern was fabricated.



Canine: Cemented Crown — Options 1 & 2

Fabricate the porcelain-fused-to-metal crown according to routine laboratory procedures. The result will be a three-piece prosthesis consisting of a screw-retained post (two-piece) for the implant, and a porcelain-fused-to-metal crown that will be cemented onto the post.

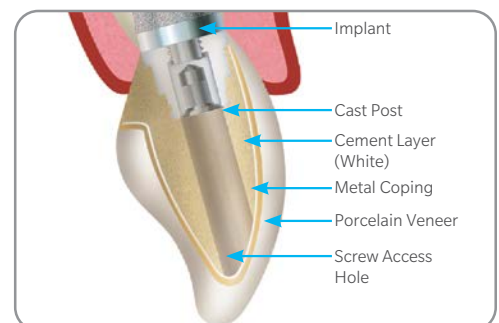

Carefully polish the finished prostheses without damaging the machined interfaces or crown margins. Attach additional Implant Analogs to the prostheses prior to polishing.

Reseat the prostheses on the working cast and return them to the clinician for final delivery.



Delivering The Final Prosthesis

Remove the prostheses and abutment from the working cast and sterilize them. Remove the provisional restorations and use the Hex Tool [HXGR1.25, HXLGR1.25] to remove the healing components.

Interdigitate the hexes of the abutments and the hexes of their corresponding implants. Thread the abutment screws through the abutment bodies and into the implants with the 1.25 mmD Hex Tool [HXGR1.25, HXLGR1.25, HX1.25, HXL1.25]. Tighten the abutment screws to 30 Ncm with a calibrated Torque Wrench [TWR]. Wait ten minutes, then retighten the screws. Take a radiograph to verify complete seating of the cast abutment and combined abutment-and-crown.

Provide the patient with oral hygiene instructions prior to release.



Custom “Cast-To” Restorations

“Cast-To” Gold Abutments, Non-Engaging

Considerations:

- Used in multiple-unit cases (e.g., bars and bridges), when anti-rotation of the abutment is not necessary
- Used for subgingival margins, when minimum interocclusal space is available, when the soft-tissue thickness is minimal and for treating divergent/convergent implants
- Minimum vertical clearance between the implant interface and the opposing dentition is 3.75 mmL and 3.5 mmL, respectively
- Maximum reduction height is 3.75 mm above the implant interface
- Not for use with cemented prosthesis
- Not for use with non-precious metal alloys
- Not for use in single tooth cases
- Porcelain cannot be bonded directly to the gold base portion of the coping
- Do not use when long axis correction greater than 30° is required

Specifications:

- Platform Sizes: 3.5 mm, 4.5 mm

Instrumentation Needed:

- 1.25 mmD Hex Tool [HXGR1.25, HXLGR1.25, HX1.25, HXL1.25]
- Torque Wrench [TWR] and Torque Wrench Hex Driver [TW1.25, TW1.25L]

For additional information, refer to the Instructions for Use located at <https://labeling.zimmerbiomet.com>.

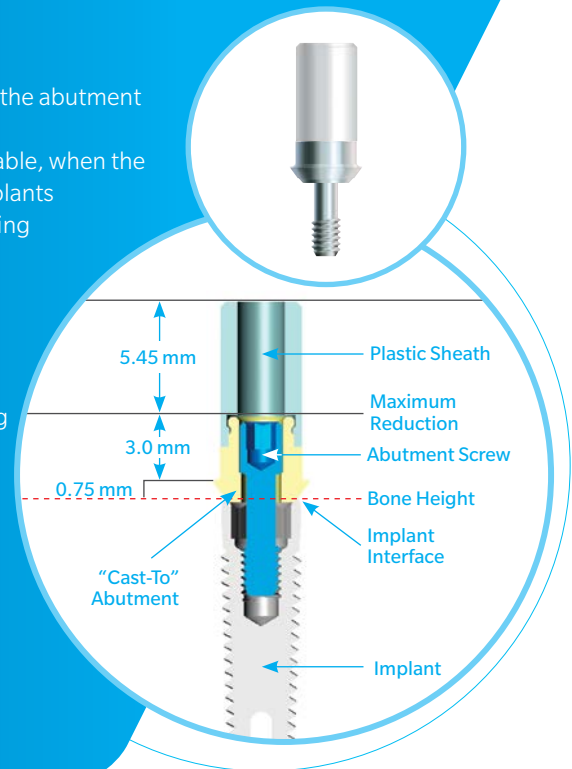

Selecting the Non-Engaging “Cast-To” Gold Abutment

Fabricate the working cast utilizing one of the procedures mentioned in the transfer section. Non-Engaging “Cast-To” Gold Abutments are for 3.5 mmD and 4.5 mmD Tapered Screw-Vent Implant platforms [NEA3G and NEA4G]. These component assemblies consist of a non-hexed, gold “Cast-To” abutment body, Abutment Screw [MHLAS] and 3.8 mmD press-fit Plastic Sheath.

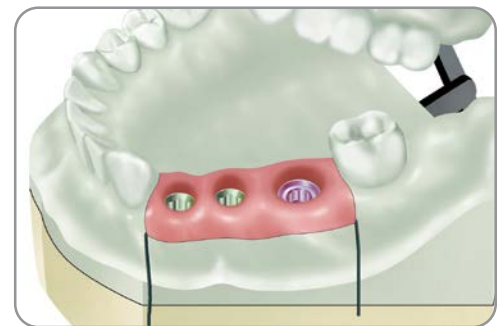

Attaching the Abutments and Plastic Sheaths

These abutments are selected in this case due to the limited vertical clearance between the implant platform and the occlusal surface of the opposing dentition. The vertical limitation prevents the use of the Tapered Abutment System.

Carefully seat the assemblies onto the Implant Analogs in the working cast. Thread the abutment screws through the abutment assemblies and into the Implant Analogs with the 1.25 mmD Hex Tool [HXGR1.25, HXLGR1.25, HX1.25, HXL1.25]. To fully seat the abutments, tighten the abutment screws to 30 Ncm with a calibrated Torque Wrench [TWR].

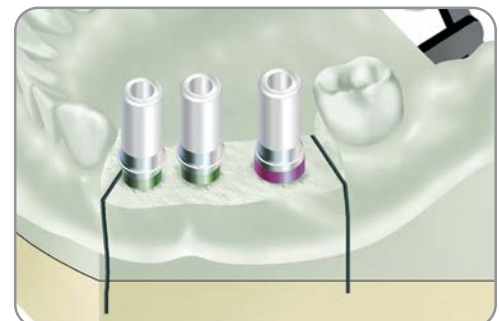

Trimming the Plastic Sheaths

Visually determine the modifications needed to provide adequate clearance for adjacent and opposing dentition. Consult with the clinician to determine any additional modifications needed for the case design. Section the Plastic Sheaths with a cutting disk to obtain the correct vertical and interproximal clearance. Minor circumferential changes can be made to the gold base to allow the framework to fit within the profile of the desired restoration.



Fabricating the Framework Pattern

Use wax and/or acrylic burnout resin to incorporate the modified gold base and Plastic Sheaths into the pattern. Build up the final contours of the pattern with crown and bridge wax. Carefully apply a thin layer of wax or burnout resin at the junction of the abutment and the Plastic Sheath to ensure a smooth casting. An alternative to using the Plastic Sheaths and Abutment Screws:

- Secure the abutments to the Implant Analogs with the Waxing Screws [MTWSD for internal hex implants].
- Lightly lubricate the Waxing Screw.
- Use wax and or acrylic burnout resin and fabricate the framework pattern around the screw and directly to the abutments.



Removing the Framework Pattern

Create a very thin cut between the components to section the framework. Use wax or burnout resin to lute the sections together. This process is incorporated to relieve the stresses in the framework pattern created by contraction distortion of the wax or resin used in the fabrication of the framework pattern.

Remove the abutment screws with the 1.25 mmD Hex Tool [HXGR1.25, HXLGR1.25, HX1.25, HXL1.25] then remove the framework pattern from the Implant Analogs.



Custom “Cast-To” Restorations

Spruing, Casting and Divesting of the Metal Framework

Attach 10-gauge sprue wax to the thickest part of each unit. Add auxiliary sprues and vents to prevent porosity in the casting as needed. Connect the framework to a runner bar then assemble to rubber casting base. Do not use a debubbler when investing the gold or plastic components

When casting to gold components, the casting alloy must not exceed a casting temperature of 2350°F/1288°C. Cast the framework pattern according to conventional techniques utilizing a two-stage burnout, which is standard practice with patterns containing plastic or resin. The burnout temperature should not exceed 1500°F/815°C, with a hold time of no longer than 1 hour. Utilize high noble or noble alloy with a compatible investment material, as described in the manufacturer’s guidelines.

Divest the casting; chemical investment removers may also be used with gold components. To ensure that the fitting surface of the incorporated copings are not damaged, protect the abutment interface while blasting the abutment with non-abrasive glass bead. Clean the casting in an ultrasonic unit. Refine the screw access holes within the casting by hand-rotating a reamer tool for “Cast-To” or castable abutments.

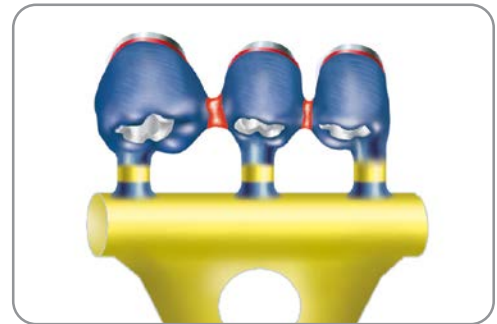
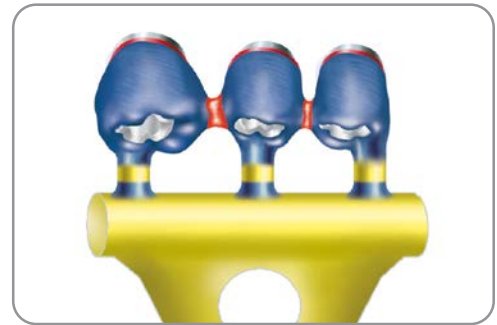

Finishing the Metal Framework

Remove the soft-tissue replica from the working cast to provide visual access to the cast metal frame/implant analog connection. Confirm a passive fit has been achieved.

Secure the finished framework to the Implant Analogs in the working cast and return it to the clinician for try-in.

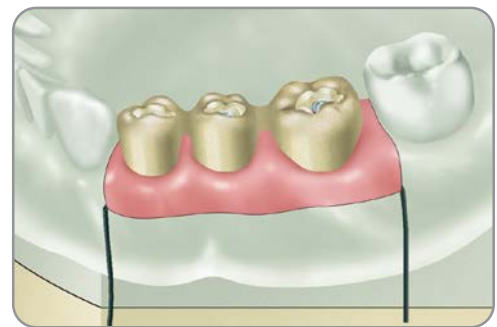

Removing the Healing Components

Unthread the abutment screws with the 1.25 mmD Hex Tool [HXGR1.25, HXLGR1.25, HX1.25, HXL1.25]. Remove the cast framework from the working cast. Clean and sterilize the components according to validated parameters in the product’s Instructions for Use.

Remove the provisional restoration from the patient’s mouth. Unthread the Healing Collars or Surgical Cover Screws with the 1.25 mmD Hex Tool [HXGR1.25, HXLGR1.25]. Clean and sterilize the components for placement after the cast framework try-in.

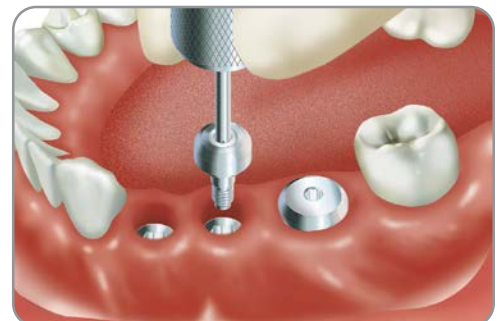

Trying in the Metal Framework

To determine a passive fit, a distal gold component incorporated within the cast metal framework is attached to its corresponding implant with an Abutment Screw [MHLAS]. Finger-tighten the screw with the 1.25 mmD Hex Tool [HXGR1.25, HXLGR1.25, HX1.25, HXL1.25]. The metal framework is then inspected to verify that no discernable gaps are present between the remaining components and implants. If a gap is present, determine where the framework should be sectioned.

Return the framework to the laboratory on the working cast for final processing of the fixed partial denture.



Finishing the Final Prosthesis

Prepare the metal framework to receive the opaque layer according to routine laboratory procedures. Apply porcelain to the framework and ensure that no porcelain flows inside the screw access channel. Refine the screw access channel within the prosthesis by hand-rotating a reamer tool for “Cast-To” or castable Abutments.

Finish the porcelain and polish any metal margins, taking care to not alter the area which interfaces with the implant. Seat the finished prosthesis on the working cast and send it to the clinician for final delivery.



Delivering the Final Prosthesis

Remove the provisional restoration and/or healing components from the patient’s mouth. Sterilize and seat the finished prosthesis onto the implants. Thread the abutment screws into the implants with the 1.25 mmD Hex Tool [HXGR1.25, HXLGR1.25, HX1.25, HXL1.25]. Torque the screws to 30 Ncm with a calibrated Torque Wrench [TWR].

Confirm the fit, contour and occlusion of the restoration, and make any needed final adjustments. Seal the screw access channels in each abutment with cotton pellets and composite resin material to complete the contour and aesthetics of the restoration. Provide the patient with oral hygiene instructions prior to release.



Screw-Retained Restorations

Tapered Abutment System

Tapered Abutment Straight

Considerations:

- For use when screw-retained splinted multiple-unit prosthesis is desired, such as bars and bridges
- Implants must be within 30° of parallelism to each other for a splinted prosthesis
- Minimum vertical clearance between implant platform and opposing dentition is 5.4 mmL
- Maximum reduction height is 3.4 mm above the cuff height chosen
- Not for use as a single tooth restoration, with cemented prosthetics, with limited interocclusal space less than 6 mm, or when implants are convergent or divergent greater than 30°
- The abutment cannot be prepared
- If using the tapered abutment gold coping, do not use with a non-precious metal alloy
- Porcelain will not bond directly to the gold coping

Specifications:

- Platform Sizes: 3.5 mm, 4.5 mm, 5.7 mm
- Cuff Heights: Variety ranging from 0.75 mm to 5.0 mm

Instrumentation Needed:

- 1.25 mmD Hex Tool [HXGR1.25, HXLGR1.25, HX1.25, HXL1.25]
- Torque Wrench [TWR] and Torque Wrench Hex Driver [TW1.25, TW1.25L]

NOTE: For Tapered Abutment technique information, consult the Revitalize® technique guide, ZBINST0023. For additional information, refer to the Instructions for Use located at <https://labeling.zimmerbiomet.com>.

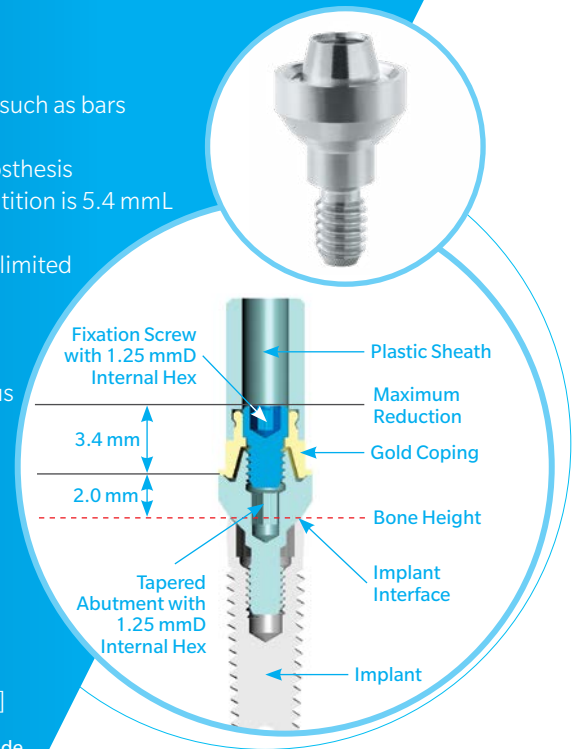

Angled Tapered Abutment

Considerations:

- Used for a terminal or intermediate abutment for screw-retained multiple-unit restorations
- Allows for additional 15° of angulation correction for splinted restorations
- For use in limited interocclusal space greater than 7.5 mm
- Not for use as a single-tooth restoration or with a cemented prosthesis
- Not for use when implants are divergent greater than 45° with the 30° Angled Tapered Abutment or when implants are divergent greater than 30° with the 15° Angled Tapered Abutment
- The Angled Tapered Abutment may not be prepared
- If using the tapered abutment gold coping, do not use with a non-precious metal alloy

Specifications:

- 1.2 mm low-profile cone allows for use in limited interocclusal space
- Platform Sizes: 3.5 mm, 4.5 mm
- Cuff Heights: 2.0 mm/4.0 mm, 3.0 mm/5.0 mm, 4.0 mm/6.0 mm

Instrumentation Needed:

- 1.25 mmD Hex Tool [HXGR1.25, HXLGR1.25, HX1.25, HXL1.25]
- Torque Wrench [TWR] and Torque Wrench Hex Driver [TW1.25, TW1.25L]
- Angled Tapered Abutment includes an abutment delivery tool

NOTE: For Tapered Abutment technique information, consult the Revitalize® technique guide, ZBINST0023. For additional information, refer to the Instructions for Use located at <https://labeling.zimmerbiomet.com>.



Components for Tapered Abutment System

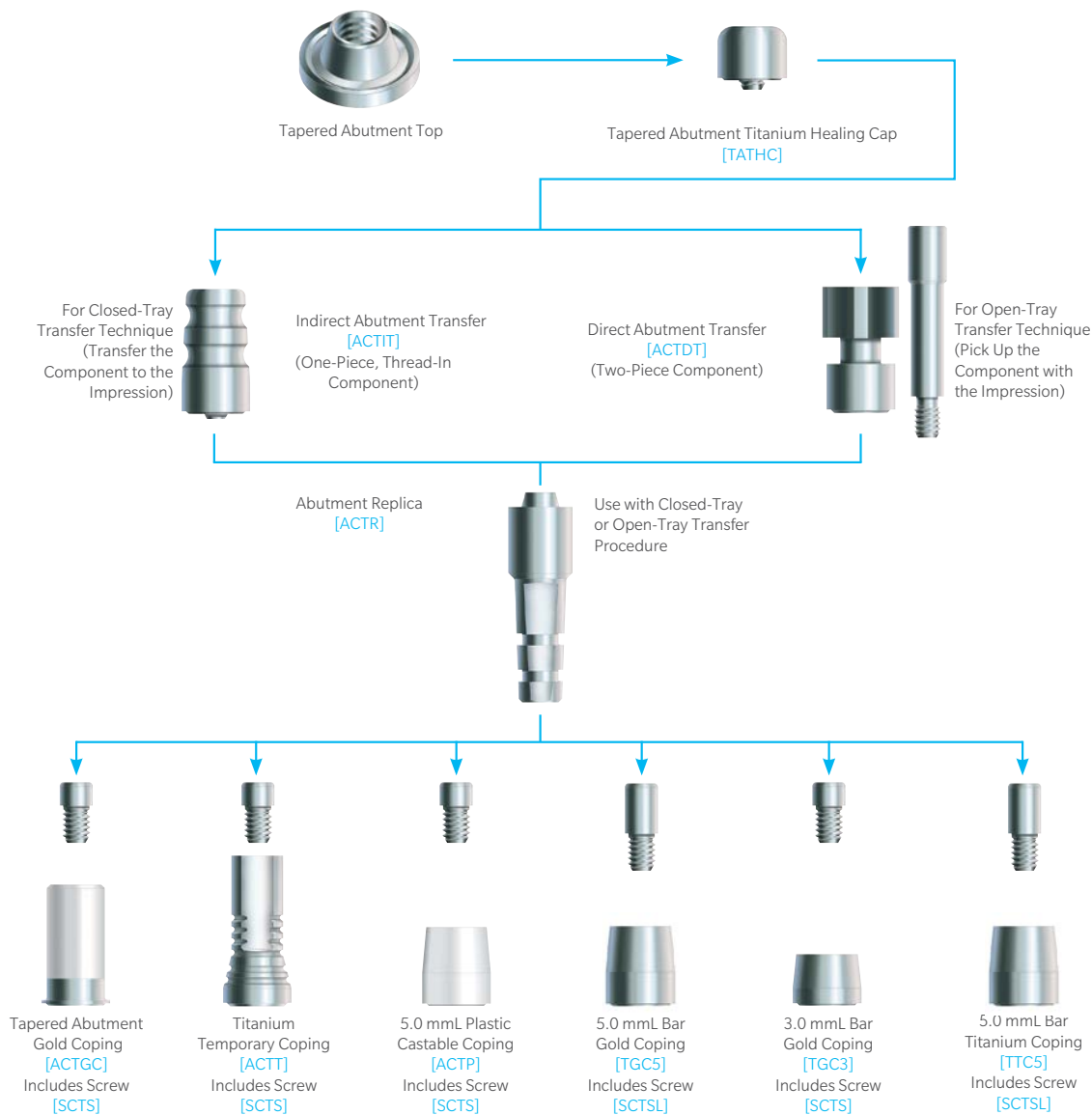

Screw-Retained Denture Options



Screw-Retained Denture



Screw-Retained Denture, Angulation Correction

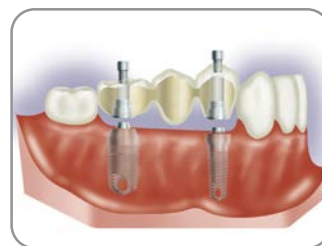

Screw-Retained Partial Denture

Overdenture Abutments

LOCATOR Overdenture Attachment System

Considerations:

- Used with overdentures or partial dentures, retained in whole or in part, by endosseous implants in the mandible or maxilla
- Not appropriate where a totally rigid connection is required
- Use on a single implant with divergence of greater than 20 degrees is not recommended

Specifications:

- Low vertical height
- Platform Sizes: 3.5 mm, 4.5 mm, 5.7 mm
- Cuff Heights: Variety ranging from 0.0 mm to 6.0 mm

Instrumentation Needed:

- 1.25 mmD Hex Tool [HXGR1.25, HXLGR1.25, HX1.25, HXL1.25]
- Torque Wrench [TWR] and Torque Wrench Hex Driver [TW1.25, TW1.25L]
- LOCATOR Core Tool [LOCCT2]

NOTE: For LOCATOR R-Tx® Removable attachment system technique information, consult the LOCATOR R-Tx technique manual, ZBINST0002. For additional information, refer to the Instructions for Use located at <https://labeling.zimmerbiomet.com>.

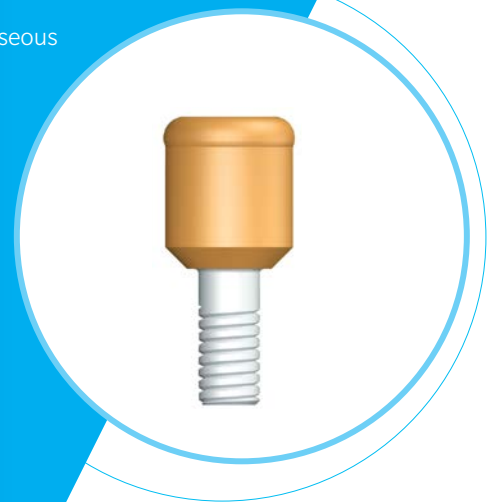

Preparing the Implant Site for LOCATOR Attachments

Remove the healing components from the implants with the 1.25 mmD Hex Tool [HXGR1.25, HXLGR1.25]. Ensure all bone and soft-tissue are removed from the superior aspect of the implant for complete seating of the LOCATOR Attachment.

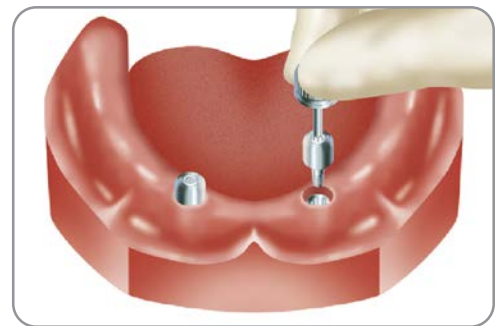

Selecting the LOCATOR Attachments

Choose a cuff length based on the tissue depth. Determine the tissue depth by measuring from the coronal rim of the implant body to the crest of the soft-tissue in three or four areas. Choose the corresponding abutment cuff height that equals the tissue measurement or is the next closest higher size. The exact tissue cuff height of the LOCATOR Abutment will position the proper amount of working attachment above the surrounding gingival level.

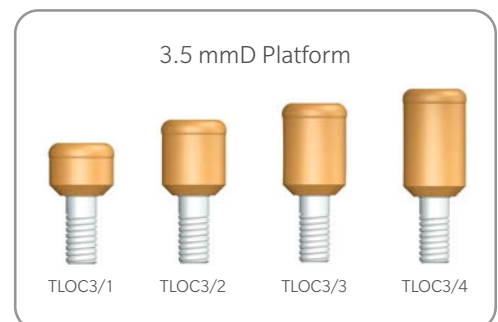

Seating the LOCATOR Attachments

Insert the LOCATOR Abutment into the implant and rotate into position using the Abutment Driver.



Tightening the LOCATOR Attachments

Insert a 1.25 mmD Hex Tool [HX1.25, HXL1.25] into the back end of the Abutment Driver. Apply a minimum of 20 Ncm of torque with a calibrated Torque Wrench [TWR]. As an alternative, use the LOCATOR torque wrench Insert Driver with the torque wrench for tightening of the abutment.

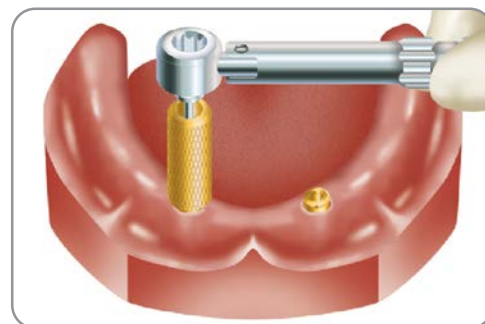

Determining Divergence and Selecting Replacement Males

Attach the Parallel Posts to the abutments to determine the degree of divergence. If the divergence is less than 10° use one of the LOCATOR Replacement Males (clear=5 lbs., pink=3 lbs. or blue=1.5 lbs.). If the angle is between 10° and 20° use an Extended Range Replacement Male (green=4 lbs. or red=1.5 lbs.) which can accommodate a divergent implant up to 20° (40° between implants).

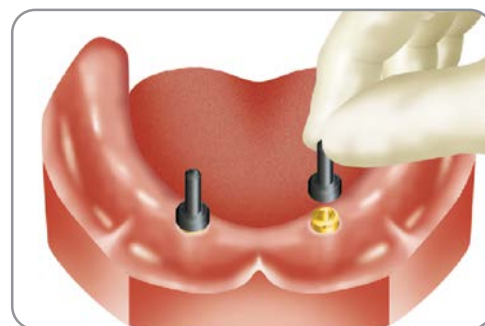

The Standard Transfer Procedure

Place the LOCATOR Impression Coping with black Processing Male onto each LOCATOR Attachment. Inject light-body impression material around the transfers in a “wash” technique and then record a full-arch impression with standard body material. The LOCATOR Impression Coping is retained in the impression material.

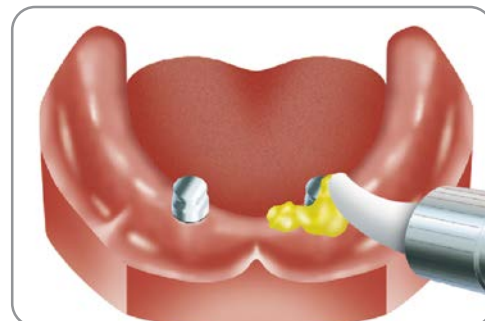

Overdenture Abutments

Completing the Standard Transfer Procedure

Insert the Abutment Analogs into the Impression Copings located within the impression material.

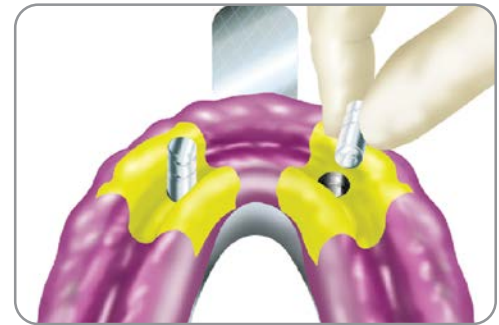

Completing an Alternative Reline Impression

An optional technique is to use the patient's prosthesis in combination with the Processing Cap with black Processing Male for a reline impression. When the denture is removed, the Processing Cap Male will remain in the denture. Snap the Analog into the Processing Male, making sure it is fully seated.

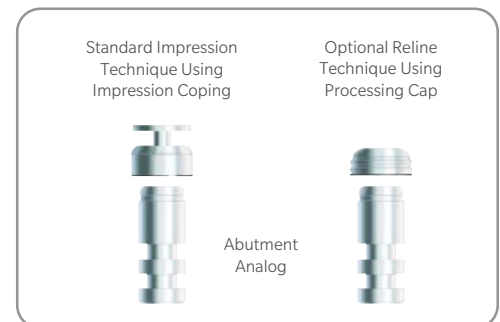

Processing the Denture

Pour the working cast. The LOCATOR Abutment Analog replicates the position of the LOCATOR Attachment on the model. Place the white Block-Out Spacer over the head of the LOCATOR Abutment Analog. The space created will allow the full resilient function of the pivoting metal denture cap over the LOCATOR Male. Attach the Processing Cap with black Processing Male and ensure it is fully seated. The black Processing Male will maintain the overdenture in the upper limit of its vertical resiliency during the processing procedure. Process the denture following standard procedures. Discard the white spacer. Before changing to the final male, polish the denture base.



Removing the Black Processing Male

Loosen the LOCATOR Male Removal Tool tip a full two turns counter-clockwise and insert the tip into the cap/male assembly and push straight in [Fig. 1]. The sharp edge of the tip will grab the Nylon Male and allow you to pull it out. Tighten the tip clockwise back into the Core Tool to release the liner [Fig. 2].

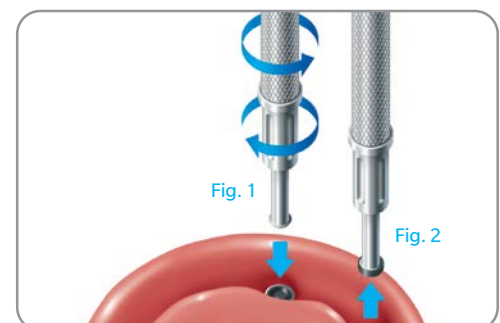

Seating the Replacement Male

Use the LOCATOR Male Seating Tool to firmly push the LOCATOR Replacement Male into the empty metal cap located within the denture. The male component must sit flush with the rim of the metal cap.

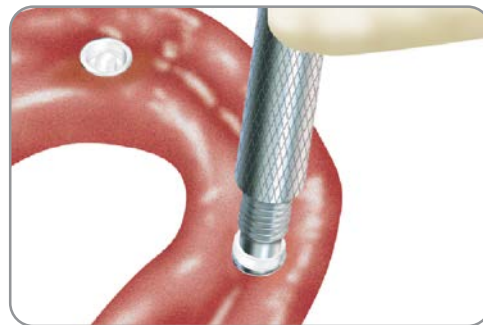

Delivering the Final Prosthesis

The LOCATOR Attachments should be re-tightened with a minimum of 20 Ncm of torque. Instruct the patient in the path of insertion. Have the patient insert and remove the appliance several times. The self-locating design helps guide the attachment into place on the abutments.

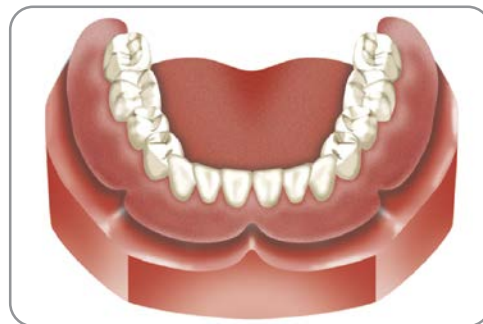

Overdenture Abutments

Ball Abutment System

Considerations:

- For retaining overdentures or partial dentures when resilience and facilitated oral hygiene are desired
- Not for use when implants are convergent or divergent by greater than 11°, or when implants are less than 6.5 mm apart (center to center), or when there is less than 7 mm of inter-occlusal space coronal to the implant

Specifications:

- Ball abutment has a coronal diameter of 4.5 mmD while the ball components is 2.5 mm
- The vertical height of the Cap Attachment (CA) above the coronal aspect of the Ball Abutment Collar is 4.28 mm and its diameter is 5.0 mm
- Platform Sizes: 3.5 mm, 4.5 mm, 5.7 mm
- Cuff Heights: 2.0 mm, 4.0 mm, 6.0 mm

Instrumentation Needed:

- 1.25 mmD Hex Tool [HXGR1.25, HXLGR1.25]
- Torque Wrench [TWR] and Torque Wrench Hex Driver [TW1.25, TW1.25L]
- Cap Attachment Instruments [CAI]

For additional information, refer to the Instructions for Use located at <https://labeling.zimmerbiomet.com>.

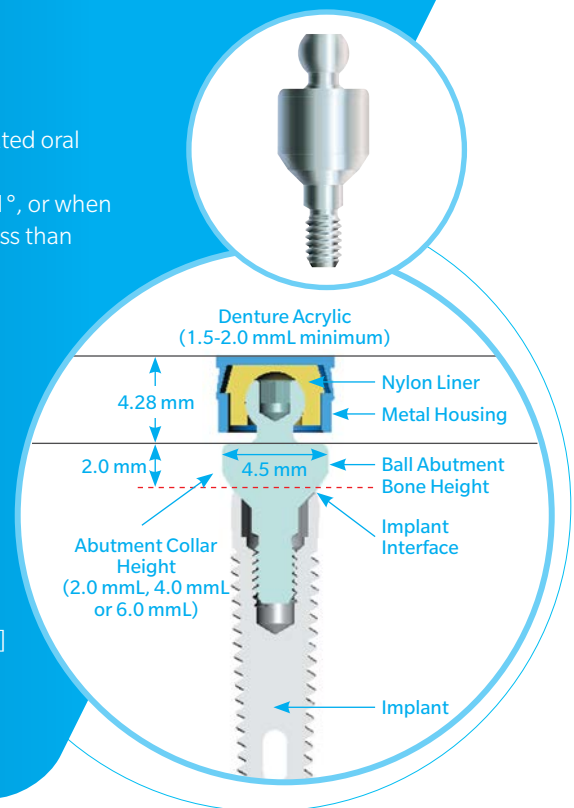

Fabricating a Custom Tray

Prior to attaching the abutments, make a full-arch, alginate impression of the Healing Collars and edentulous areas. Send the impression to the laboratory for fabrication of a working cast and an impression tray with a spacer to accommodate the Ball Abutment Transfers. Fabricate the custom tray with light-cured or autopolymerizing tray material. The patient's existing, modified overdenture can continue to be worn during the laboratory phase. Alternatively, select a stock tray to provide access for the transfers, and mold a border with greenstick compound material.

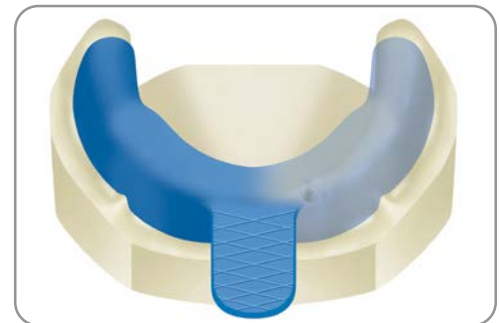

Attaching the Ball Components

Recall the patient when the custom tray is ready. Remove the Healing Collars or Surgical Cover Screws with the 1.25 mmD Hex Tool [HXGR1.25, HXLGR1.25]. Select Ball Abutment components according to the implant type and transmucosal height requirements. Place the selected Ball Abutments into the implants and tighten with to 30 Ncm with a calibrated Torque Wrench [TWR].



Seating the Transfers

Press the Ball Abutment Transfers [BAT] for all 4.5 mmD collar components onto the Ball Abutments. This step cannot be done on the 5.7 mmD platform implant systems.

The transfer will engage the outer portion of the abutment beneath the ball for maximum stabilization. An elastomeric impression material is recommended, such as vinyl polysiloxane. Inject light-body impression material around the Ball Abutments and fill the impression tray with heavier-body impression material. Place the loaded tray into the patient's mouth and allow the impression material to set according to the manufacturer's recommendations. Remove the impression from the mouth.



Completing the Transfer Procedure

Remove the Ball Abutment Transfers from the Ball Abutments, press them onto the Ball Abutment Replicas [BAR], and insert them back into the impression holes. A double-click indicates that the transfers are fully seated. Make an opposing-arch impression. Send all the materials to the laboratory for fabrication of a stabilized baseplate with occlusal registration rim.

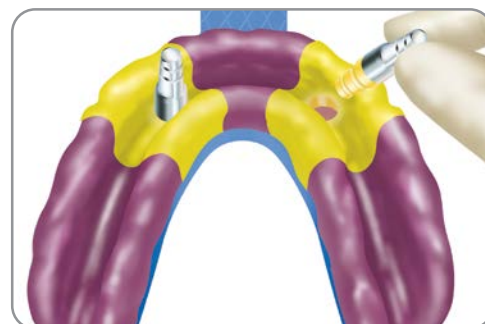

Fabricating a Stabilized Baseplate and Bite Rim

Pour the impression in die stone. Remove the tray from the cast and the Ball Abutment Transfers from the Ball Abutment Replicas now incorporated within the working cast.

Press-fit the yellow Cap Attachment Transfers [CAT] onto the Ball Abutment Replicas in the working cast. Place the Cap Attachment Housings [CAH] (included with the Ball Abutments) onto the Cap Attachment Transfers.

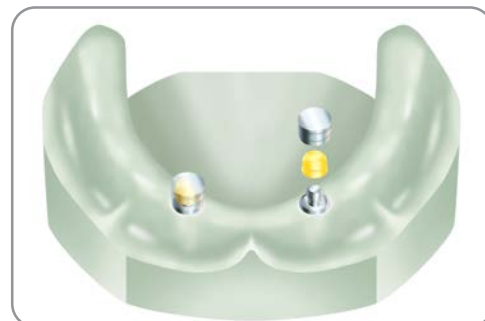

Fabricating a Stabilized Baseplate and Bite Rim

Rotate the assembled housings and transfers up to 28° to create relative parallelism for a common path of draw. Block out the undercuts beneath the housing assemblies with an appropriate silicone or wax material.



Ball Abutment System

Incorporating the Housings into the Baseplate

Place gel viscosity light-cure resin material on the Metal Housings and cure. Incorporate the housings into a stabilized baseplate made from light-cured baseplate resin. Create a wax occlusion registration rim on the stabilized baseplate. Place the assembly on the working cast and send it to the dentist for fabrication of a stabilized bite registration.



Making a Stabilized Bite Registration

Snap the yellow Cap Attachment Transfers onto the Ball Abutments in the patient's mouth. Place the stabilized baseplate and occlusal registration rim into the patient's mouth and allow the transfers to insert into the Metal Housings in the baseplate. Make a bite registration with the stabilized baseplate and occlusion rim. Send the assembly to the laboratory for fabrication of a stabilized denture wax try-in.



Making a Stabilized Denture Wax Try-In

After the laboratory fabricates a stabilized denture wax-up, recall the patient for try-in. Snap the yellow Cap Attachment Transfers onto the Ball Abutments in the patient's mouth. Place the denture wax try-in into the patient's mouth and allow the transfers to insert into the Metal Housings in the baseplate. Evaluate aesthetics and phonetics, and verify that the wax-up fits passively. If changes in tooth position are prescribed, schedule additional try-in appointments until acceptable tooth arrangement is verified and approved by dentist and the patient. Place the approved stabilized denture wax try-in on the working cast with the Cap Attachment Transfers and send it to the laboratory for final processing.



Cap Attachment Instruments

- Nylon Liner Insertion Tool: Used to carry and assist in the insertion of the Nylon Liner into the Metal Housing.
- Reaming Tool: When the Nylon Liner is too retentive for the respective patient, the Reaming Tool is inserted into the liner and rotated in a clockwise direction. This action reduces the amount of retention between the Ball Component and the Cap Attachment by reducing the dimension of the liner's inner walls. Care should be taken to do this in small increments so as not to eliminate the required retention levels of the Nylon Liner.
- Paralleling Mandril: Used by the technician in combination with a surveyor to align the castable ball patterns in the correct position when fabricating a ball bar overdenture.

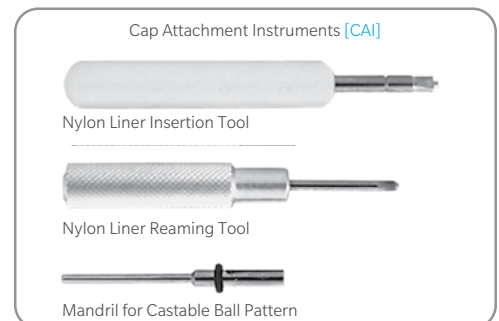

Processing the Final Prosthesis

When the processed denture returns from the laboratory, retighten the Ball Abutments to 30 Ncm with a calibrated Torque Wrench [TWR]. Place one Nylon Liner [CAN] from the Cap Attachments [CA] onto the end of the insertion tool. Use the Insertion Tool to press the Nylon Liner into one of the metal housings in the denture base. Check the retention of the liner by snapping the denture on and off the ball component in the patient's mouth. If necessary, use the Reaming Tool to decrease the retention of the Nylon Liner. When adequate retention has been achieved, process the second Nylon Liner in the same manner. Insert and adjust only one Nylon Liner at a time.



Delivering the Final Prosthesis

Insert the finished prosthesis into the patient's mouth and snap the incorporated Cap Attachments onto the Ball Abutments. Make final adjustments to the occlusion. Instruct the patient in the use and care of the prosthesis, and provide oral hygiene instructions. Caution the patient not to use bleach on the prosthesis, which can damage the nylon Cap Attachment liners. To prolong the use of the Nylon Liners, instruct the patient to insert and remove the overdenture by lifting the prosthesis vertically instead of laterally or by twisting. If the Nylon Liners lose retention, they can be easily replaced at a recall appointment. For patients who require stronger Cap Attachment retention, gray Nylon Liners [CAN-G] with a more rigid retention are also available.



Attaching the Ball Components

Recall the patient when the custom tray is ready. Remove the Healing Collars or Surgical Cover Screws with the 1.25 mmD Hex Tool [HXGR1.25, HXLGR1.25]. Select Ball Abutment Components according to the implant type and transmucosal height requirements. Place the selected ball components into the implants and tighten to 30 Ncm with a calibrated Torque Wrench [TWR].



Preparing the Housings for Pick-Up

Snap the yellow Cap Attachment Transfers [CAT] onto the Ball Abutments. Place the Cap Attachment Stainless Steel Housings [CAH] over the transfers.

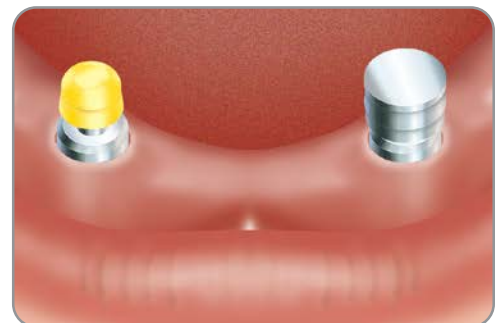

Ball Abutment System

Preparing the Housings for Pick-Up

Rotate the assembled Cap Attachment Transfers [CAT] and Metal Housings [CAH] on the Ball Abutments up to 28° to create relative parallelism for a common path of draw. Try and ensure that the components are aligned taking into consideration the occlusal plane of the denture; this will help with the smooth rotation of the denture around the Ball Abutment.

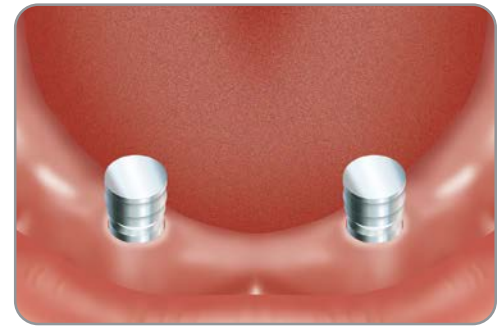

Preparing the Denture for Pick-Up

Seat the denture into the patient's mouth to determine the locations of the Metal Housings relative to the tissue-bearing surface of the prosthesis. Remove the denture from the patient's mouth and mark the locations of the assembled housings on the bottom of the prosthesis. Relieve the areas over the housings with an acrylic bur until the denture can be fully seated in the patient's mouth without contacting the Metal Housings.

Small relief holes can be drilled through the top of the recess to allow excess acrylic to exude through.

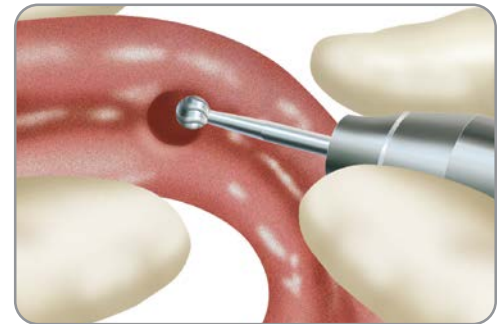

Preparing the Housings for Pick-Up

Block out the undercuts beneath the housing assemblies with an appropriate silicone or wax material, taking care not to change the orientation of the housings on the Ball Abutment.

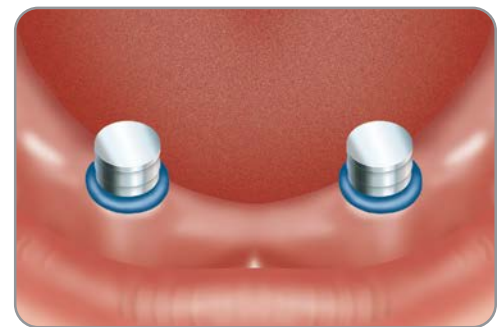

Processing the Housings into the Denture Base

Autopolymerizing acrylic is recommended for the pick-up. It flows better than a light-cured resin and engages the undercuts on the outside of the Metal Housings [CAH] more efficiently. Place a small amount of autopolymerizing acrylic into the dry, relieved areas within the denture base. Also place a small amount of acrylic directly on the tops of the housings. Place the denture over the housings in the mouth and instruct the patient to bite lightly in centric occlusion. Remove the denture after the acrylic sets. Fill in any voids remaining around the processed housings with additional autopolymerizing acrylic.



Processing the Nylon Liners into the Denture Base

Remove the yellow Cap Attachment Transfers from the Ball Abutments in the patient's mouth. Place one Nylon Liner [CAN] from the Cap Attachments [CA] onto the end of the insertion tool from the Cap Attachment Instruments [CAI]. Press a Nylon Liner into the Metal Housing in the denture base. Check the retention of the liner by snapping the denture on and off the ball component in the patient's mouth. If necessary, decrease the retention of the liner by inserting the Reaming Tool from the Cap Attachment Instruments into the liner and turning it clockwise to reduce the retention of the liner's inner walls. When adequate retention has been achieved, process the second liner in the same manner. Insert and adjust only one Nylon Liner at a time.



Delivering the Final Prosthesis

Insert the finished prosthesis into the patient's mouth and snap the incorporated Cap Attachments onto the Ball Abutments. Make final adjustments to the occlusion. Instruct the patient in the use and care of the prosthesis, and provide oral hygiene instructions. Caution the patient not to use bleach on the prosthesis, which can damage the Cap Attachment Nylon Liners. To prolong the use of the Nylon Liners, instruct the patient to insert and remove the overdenture by lifting the prosthesis vertically instead of laterally or by twisting. If the Nylon Liners lose retention, they can be easily replaced at a recall appointment. For patients who require stronger Cap Attachment retention, gray Nylon Liners [CAN-G] with more retention are also available.



Prosthetic Tools

	Description	Item No.
	Hex Driver, Short, with GemLock® Retention (1.25 mmD, 22 mmL)	HXGR1.25
	Hex Driver, Long, with GemLock Retention (1.25 mmD, 30 mmL)	HXLGR1.25
	Hex Driver, Short, Standard (1.25 mmD, 17 mmL)	HX1.25
	Hex Driver, Long, Standard (1.25 mmD, 22 mmL)	HXL1.25
	Latch-Lock Hex Driver (Short) for Surgical and Prosthetic Screws (may require Reduction Handpiece) (1.25 mmD, 23 mmL)	HX1.25D
	Latch-Lock Hex-Driver (Long) for Surgical and Prosthetic Screws (may require Reduction Handpiece) (1.25 mmD, 26 mmL)	HXL1.25D
	Torque Wrench, Restorative (adjustable torque range 10 Ncm – 35 Ncm)	TWR
	Torque Wrench Hex Driver, Short (1.25 mmD, 17 mmL)	TW1.25
	Torque Wrench Hex Driver, Long (1.25 mmD, 22 mmL)	TW1.25L
	Locator Torque Wrench Insert Driver, Short, 15 mmL	LOCTW15
	Locator Torque Wrench Insert Driver, Long, 21 mmL	LOCTW21
	Locator Core Tool	LOCCT2
	Locator Core Tool, Replacement Tip (fits LOCCT2)	LOCCTR
	Prosthetic Kit Tray, Autoclavable (empty)	2320
	Removal Tool for Internal Hex Implant Abutments	TLRT2
	Removal Screw for Internal Hex Implant Abutments	HLRS
	Abutment Holder (requires Implant Analog to attach abutments)	ABTH
	Removal Tool for Abutment Screws or Fixation Screws with 1.25 mmD Hex, Carbide Steel (do not autoclave)	SRT

1. Mihalko WM, May TC, Kay JF, Krause WP. Finite element analysis of interface geometry effects on the crestal bone surrounding a dental implant. *Implant Dent.* 1992;1:212-217.
2. Chun HJ, Shin HS, Han CH, Lee SH. Influence of implant abutment type on stress distribution in bone under various loading conditions using finite element analysis. *Int J Oral Maxillofac Implants.* 2006;21:105-202.
3. Binon PP. The evolution and evaluation of two interference-fit implant interfaces. *Postgraduate Dent.* 1996;3:3-13.



Contact us at 1-800-342-5454 or visit

zimmerbiometdental.com

Zimmer Biomet Dental
Global Headquarters
4555 Riverside Drive
Palm Beach Gardens, FL 33410
Tel: +1-561-776-6700
Fax: +1-561-776-1272

Unless otherwise indicated, as referenced herein, all trademarks are the property of Zimmer Biomet; and all products are manufactured by one or more of the dental subsidiaries of Zimmer Biomet Holdings, Inc. and marketed and distributed by Zimmer Biomet Dental and its authorized marketing partners. LOCATOR, LOCATOR R-Tx and R-Tx are registered trademarks of ZEST IP Holdings, Inc. For additional product information, please refer to the individual product labeling or instructions for use. Product clearance and availability may be limited to certain countries/regions. This material is intended for clinicians only and does not comprise medical advice or recommendations. Distribution to any other recipient is prohibited. This material may not be copied or reprinted without the express written consent of Zimmer Biomet Dental. ZBINST0028 REV C 01/20 ©2020 Zimmer Biomet. All rights reserved.

