

Trabecular Metal™ And Tapered Screw-Vent® Implant Systems

Surgical Manual

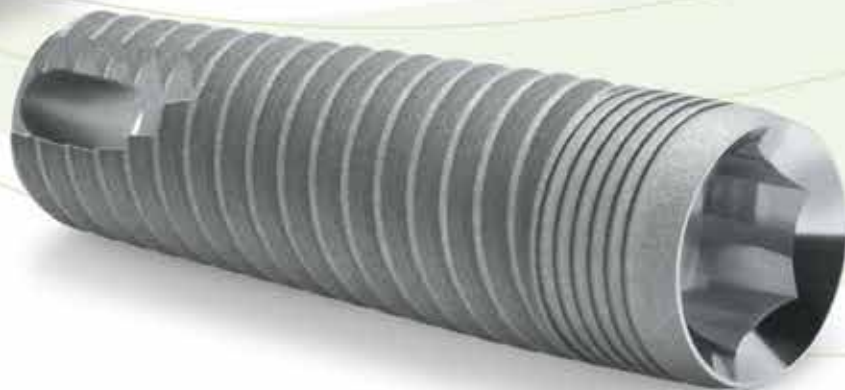

ZIMMER BIOMET
Your progress. Our promise.



Table Of Contents

| | |
|--|-----------|
| Overview | 3 |
| General Implant Information | 3 |
| Indications For Use | 3 |
| Pre-Operative Planning | 4 |
| General Considerations | 4 |
| Anatomical Criteria | 5 |
| Bone Density Classification | 7 |
| Clinical Assessment | 8 |
| Diagnostic And Surgical Guides | 10 |
| Traditional Surgery | 11 |
| Guided Surgery | 13 |
| Implant Design And Specifications | 14 |
| Implant Dimensions | 14 |
| Platform Dimensions | 16 |
| Crestal Options | 17 |
| Materials | 17 |
| Surfaces | 17 |
| Implant Packaging | 18 |
| Instrument Kit System | 21 |
| Color Reference Charts | 21 |
| TSV Surgical Kit Layout Chart | 23 |
| Drilling Sequence | 25 |
| Surgical Drills | 26 |
| Guided Surgery Module | 26 |
| Tube Adapter Kit | 27 |
| Drill Stop Kit | 28 |
| Surgical Procedures | 31 |
| General Surgical Instructions | 31 |
| Cleaning | 31 |
| Sterilization | 32 |
| Site Preparation | 33 |
| Soft- And Dense-Bone Protocols | 38 |
| Implant Placement | 39 |
| Two-Stage and One-Stage Protocols | 41 |
| Guided Surgery | 44 |
| Healing Collar Selection | 49 |

NOTE: Images shown throughout this manual are representational in nature and may not be to scale or display the exact geometry of the components.

General Implant Information

Trabecular Metal and Tapered Screw-Vent (TSV™) Implants are designed to be placed at bone level. The occlusal aspect (platform) of the implant is the receiving area for the prosthetic component of the restoration. This area of the implant is placed level with the crest of the bone when following standard implant placement procedures, although variations of placement have been clinically accepted. The implant neck and body are placed sub-crestally. The sub-crestal portion of the implant has the MTX® Microtextured Surface or Trabecular Metal or MP-1® HA Surface midsection. Select implants are ordered with and without crestal microgrooves and machined collar or texturing to the top to maximize flexibility in a variety of clinical conditions. The implant diameter is the dimension taken from the peak of the widest thread to the same point on the other side of the implant, referred to as the outside dimension of the thread. Sufficient alveolar bone width to surround the implant should be available for placement of the selected diameter. In addition, 2.0 mm of bone is recommended beyond the apical aspect of the implant.

Bone-Level Implants

- Trabecular Metal and Tapered Screw-Vent Implants are available in four body diameters: 3.7 mmD, 4.1 mmD, 4.7 mmD and 6.0 mmD.

Indications For Use

Trabecular Metal and TSV Implants are designed for use in the maxilla or mandible for immediate loading or for loading after a conventional healing period. Implants may be used to replace one or more missing teeth. Immediate loading is indicated when there is good primary stability and an appropriate occlusal load. The 3.7 mmD Trabecular Metal Implants should be splinted to additional implants when used in the pre-molar region and should not be used in the molar region. The 4.1 mmD Trabecular Metal Implants should be splinted to additional implants when used in the molar region.



General Considerations

Team Approach

Successful implant treatment often requires the coordinated efforts of several dental professionals – the restorative dentist or prosthodontist, the surgeon (periodontist, oral surgeon or general dentist), the laboratory technician and the dental hygienist. By holding a pre-surgical conference, these individuals are able to develop an appropriate treatment strategy. This provides a balance between aesthetic, functional and surgical goals. In addition, the coordinated effort ensures that the treatment approach is complete, guarding against omission of important technical considerations, such as the use of a surgical guide for implant positioning, and the biomechanical boundaries of the final prosthesis.

Patient Evaluation And Selection

- Take a general medical history
- Explore indications and contraindications
- Determine anatomical landmark considerations related to implant positioning
- Determine feasible vertical dimensions
- Consider biomechanical requirements of final restoration
- Discuss treatment objectives and patient's expectations
- Perform various radiographic and scanning evaluations

Top-Down Treatment Planning

In its simplest form, top-down treatment planning refers to a guideline whereby the desired restorative result is considered first, leading to consideration of the appropriate prosthetic platform and subsequent implant selection based on bony anatomy and the size of the missing tooth.

A top-down treatment planning methodology will provide maximum biomechanical stability and allow for soft-tissue flaring by utilizing an implant with a prosthetic platform slightly smaller in diameter than the emergence diameter of the tooth being replaced. Implant and healing abutment selections are based upon the relationship of several key measurements:

- The emerging dimension of the crown in relation to the diameter of the prosthetic platform of the implant
- The height and diameter of the intended restoration at the soft-tissue exit point
- The bone volume at the implant site in relation to the diameter of the implant body

Proper stress distribution is essential to the long-term success of both the prosthesis and the implant. Overload is one of the key contributors to implant failure and is especially important in the cuspid and molar regions.



Pre-Operative Planning

Anatomical Criteria

“How Do I Choose A Preferred Implant For The Proposed Restoration?”

This question always arises during the process of case diagnosis and treatment planning.

The design, quantity, diameter and length of implants to be placed will depend on the type of restoration planned (implant- or tissue- supported; cement- or screw-retained) as well as the following anatomical criteria:

- Quality and quantity of available bone
- A distance of 3.0 mm between implants and a distance of 2.0 mm between implants and adjacent teeth is recommended for optimal preservation of interproximal marginal bone levels and papillary soft-tissue height
- Overdenture is to be implant-supported or tissue-supported/implant retained
- Cement- or screw-retained restoration [Fig. A]

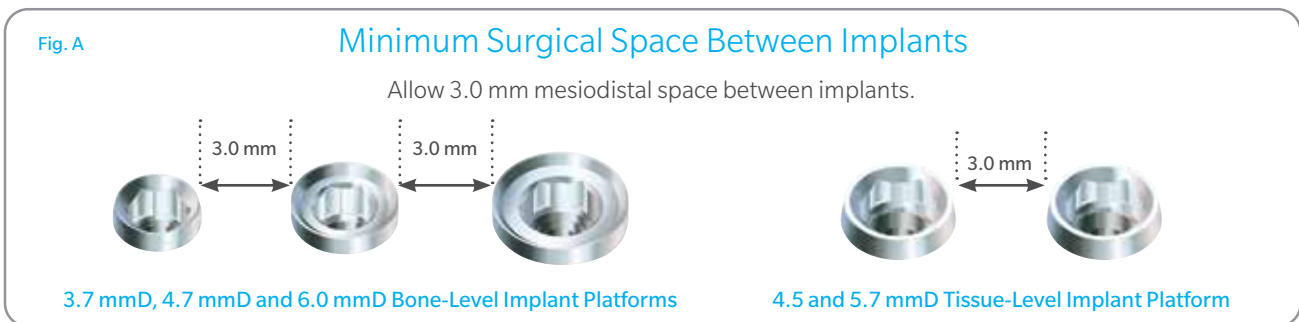

- Mesial and/or distal boundaries
 - (a) Mesial and distal borders of surrounding coronal contours. Example: In [Fig. B], the 3.7 mmD implant platform is preferable to the 4.7 mmD due to mesiodistal constraints. At least 1 mm on either side of the platform is the minimum requirement for restorative contours.
 - (b) Convergent or divergent roots. Tapered implants allow for larger diameter in this area [Fig. C].
 - (c) Mental foramina.

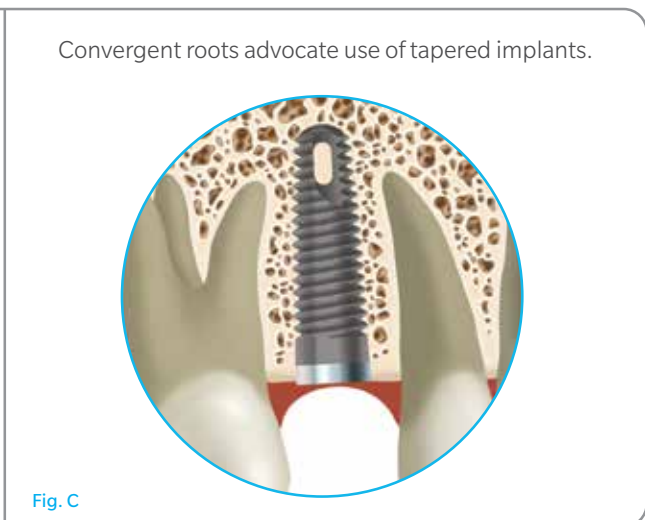
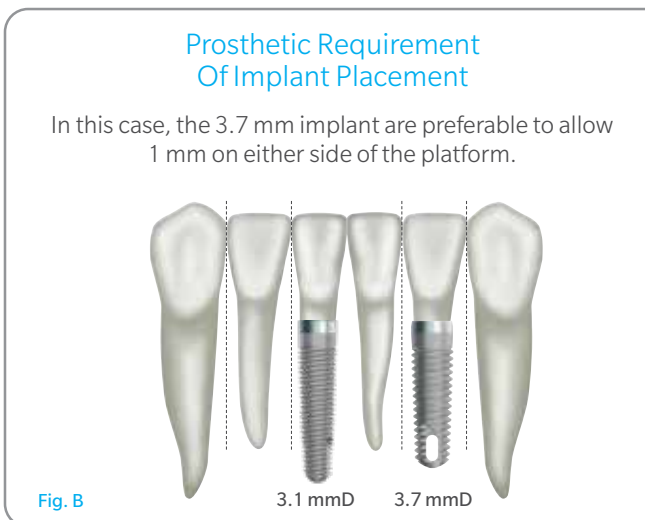

- Buccal and/or lingual boundaries
 - (a) Buccal and/or lingual restoration contours. Minimum requirement for restorative contours is 1.0 mm on either side of the platform diameter.
 - (b) Restorations require space for sub-structures and substantial veneering materials (i.e., denture).
 - (c) Buccal and/or lingual osseous depressions require the use of narrow or tapered implants [Fig. D].
 - (d) Width of the crestal bone requires the use of implants that have a neck diameter which allows for a minimum of 1.0 to 1.5 mmD of bone on buccal and lingual borders [Fig. D].
 - (e) Available bone to allow placement such that the occlusal force is axial through the center of the implant body.
- Anatomical vertical limitations
 - (a) Maintaining a distance of 1.0 mm to 2.0 mm between the maximum osteotomy depth and the superior boundary of the mandibular canal is recommended to avoid impingement of the neurovascular bundle [Fig. E].
 - (b) Allow spacing below the floor of the sinus cavity unless sinus grafting procedures are planned.
 - (c) Correct the plane of occlusion of opposing dentition to eliminate the restriction often created by over-eruption of unopposed dentition. This will allow for sufficient space for the final restoration.
 - (d) If free-standing retentive anchors are proposed for the restoration, implants greater than 10 mm are recommended when sufficient ridge height is available to prevent excessive lateral load being applied to the implant.
 - (e) Placement of the restorative platform at bone level [Fig. E] will ultimately determine the length and type of implant to be placed.

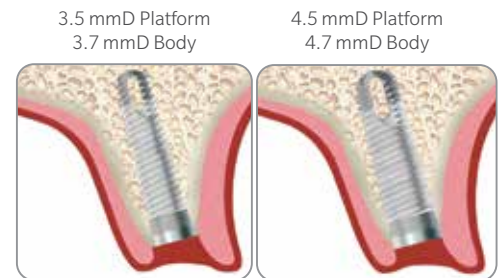

Fig. D Buccolingual bone requirements (1-1.5 mmD) in some cases advocate use of a narrower implant.

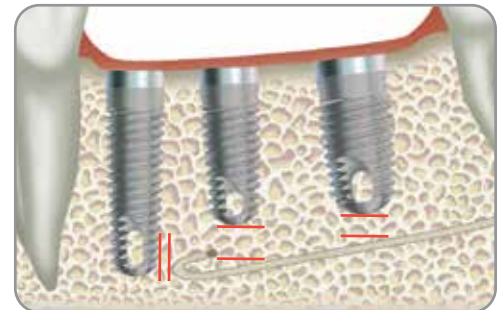

Fig. E Allow spacing of at least 2.0 mm above the mandibular canal (Illustration not to scale). Implants are designed to be placed at bone level.

Clinical Assessment

Treatment Planning Considerations:

Proper treatment planning, as well as the selection of the proper implant length and diameter, are crucial to the long-term success of the implant and restoration.

Before an implant can be selected, the anatomical foundation available to receive the implant must be carefully assessed. Several steps should be taken to complete the evaluation:

1. Clinical examination of the oral cavity can provide important information about the health of the soft tissue at the proposed implant site. Tissue tone and the state of the superficial tissues should be evaluated. In addition, the patient should demonstrate an adequate dimension of attached gingiva or keratinized tissue at the site selected for implantation. In partially edentulous cases, the periodontal status of the remaining dentition should be assessed and interaction between the implant restoration and the adjacent natural dentition should be considered.
2. The bony foundation and ridge need to be clinically analyzed to ensure the presence of proper dimensions and the amount of bone for implant placement. At least one millimeter of bone should be present at the buccal and lingual aspects of the implant following placement. During the planning stage, it is useful to measure the existing bone foundation.

NOTE: Please ensure as many implants as necessary are used for a fully stable restoration.

CT Scans:

Computed tomography (CT) scans help surgeons view parts of the body with three-dimensional images. Image-guided surgical planning allows surgeons to see anatomical landmarks such as nerves, sinus cavities and bony structures in order to plan for the placement of dental implants and prostheses.

Through the use of CT scans, clinicians are able to more precisely measure the locations of anatomical structures, dimensions of the underlying bone and ascertain bone densities in order to plan and treat clinically demanding cases.

Radiographic Transparencies:

The vertical height of the bone can be determined radiographically. Accurate measurement of the vertical dimension on the radiograph facilitates the selection of the appropriate implant length. This helps to avoid implant placement into the maxillary sinus, the floor of the nose or the mandibular canal, and prevents perforation of the inferior aspect of the mandible. Measurements can be made directly on the panoramic radiograph using a millimeter ruler. Corrections should be made for the degree of enlargement or reduction produced by the particular radiographic equipment.

Radiographic marking balls of a known dimension can be embedded in a plastic template prior to radiographic examination. Once the radiograph is taken and the metal marking balls are visible on the image, measurements can be taken to determine the amount of bone available for implant placement.

To calculate the distortion factor, a simple formula can be utilized: $(5 \div A) \times B =$ the amount of actual bone available.

Formula Key =

- Radiographic marking ball = 5.0 mm in diameter.
- A = Size of marking ball image on radiograph.
- B = Length in millimeters on the radiograph of available bone between the crest of the ridge and the inferior alveolar canal.

Example:

$$A = 6.5 \text{ mm}$$

$$B = 14 \text{ mm}$$

Therefore: $(5 \div 6.5) \times 14 = 10.76 \text{ mm}$ actual bone available

NOTE: A 2.0 mm margin of safety, from the apical end of the implant to any adjacent vital structure, should be considered.

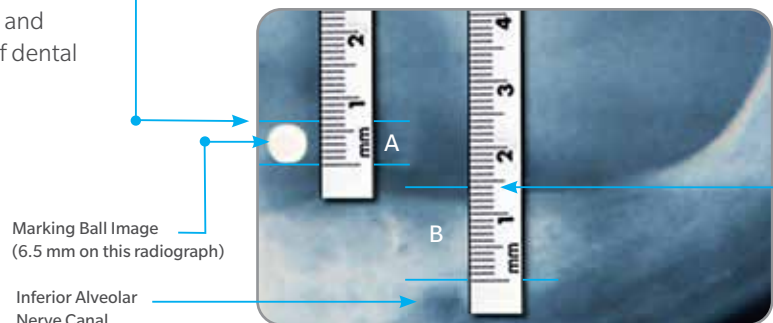

Pre-Operative Planning



Radiographic Transparencies Instructional Steps:

A dental implant radiographic transparency supports the preoperative implant treatment planning process. A radiographic transparency is overlaid onto a radiograph to assist the clinician in the preoperative determination of options for implant length and diameter. It is used in conjunction with a 5.0 mm radiographic marking ball. Representations of the implant and the 5.0 mm radiographic marking ball are shown on the radiographic transparency at 100% and 125% scales.

Visually inspect the transparency before each use for damage. The transparency should not be used if damaged or deteriorated. The following steps outline the proper use of the radiographic transparency in conjunction with the 5.0 mm radiographic marking ball(s) during preoperative planning:

1. Overlay the 100% and 125% scaled 5.0 mm circular radiograph ball outline found on the transparency over the 5.0 mm radiographic ball image on the radiograph and determine which outline is closest to the diameter of the radiographic ball image on the radiograph. If the radiographic ball image on the radiograph extends outside the circular border of the radiographic ball outline on the 100% scale, use the 125% scale for measurement estimations. If the radiographic ball image extends outside the circular border of the radiographic ball outline on the 125% scale, DO NOT use this radiographic transparency and refer to the Radiographic Marking Balls procedure to determine approximate bone height (See section on calculation of distortion factor on page 8).

NOTE: The radiographic ball should maintain its spherical

shape on the radiograph, otherwise distortion that cannot be measured may have occurred. If this happens, it is recommended that a new radiograph be taken.

2. Select the scale (100% or 125%) to use based on which circular radiograph ball outline best matches the diameter of the radiographic ball image on the radiograph.
3. To determine an approximation of available vertical bone height at the proposed implant site, align the zero mark on the selected ruler (100% or 125%) to the crest of the edentulous ridge and measure the length between the crest and anatomical structures in the proposed implant site including the floor of the maxillary sinus, the floor of the nose and the mandibular canal.

NOTE: A minimum of 2.0 mm margin of safety, from the apical end of the implant to the adjacent vital structure, should be considered.

4. Overlay the implant silhouette corresponding to the selected scale (100% or 125%) onto the proposed implant site to visually estimate if adequate vertical bone height is present for the selected implant length.

NOTE: The intended use of the TSV Radiographic Transparency (RT-TSV) is exclusively for preoperative planning and to be used as a guide. Implant length and diameter should not be determined solely by relying on the radiographic transparency.

Diagnostic And Surgical Guides

Implant dentistry is guided by the restorative aspect of the procedure. Therefore, it is a prerequisite to evaluate the position of the surrounding anatomical landmarks and natural teeth relative to the proposed area for implant placement.

Rule of “P” – Proper Pre-treatment Planning Prevents Prosthetic Problems.

Fabricate diagnostic casts with a wax-up of the proposed position of the teeth in the implant prosthesis.

The Implant Team will utilize the diagnostic casts to fabricate the following, if required:

- Diagnostic guide with included markers for a variety of radiological exams – panoramic, periapical, computerized tomography (CT/CBCT scan), etc. These exams can supply the team with information regarding bone quality and quantity, location of vital structures (mental nerve canal, sinus cavities, labial or lingual bone contour, and surrounding roots if present), and soft-tissue height relative to the occlusal plane (see pages 11-12).
- A traditional, model-based surgical guide to be utilized at time of surgery for implant osteotomy preparation, taking into consideration mesiodistal and buccolingual angulation and placement of the implants while maintaining required distance between the implants. Some surgical guides can be resterilized and used by the restoring clinician to plan the contours of the final prosthesis. The guide may also be used in the decision-making process for abutment selection and preparation and/or recording of the final implant or abutment impressions (see pages 11-12).
- A software-based surgical guide to be utilized at time of surgery for implant osteotomy preparation. The guide is based on a 3D case plan and fabricated by a treatment planning software supplier or dental laboratory (see page 13).

Pre-Operative Planning

Traditional Surgery

Fabrication Of A Diagnostic And Surgical Guide

Recording An Impression

Use standard impression techniques to record an impression of the edentulous area with surrounding anatomical landmarks and the opposing arch.

1. For partially edentulous areas, make inter-occlusal records of the opposing arches in centric relation.
2. For fully edentulous areas, follow standard procedures for fabrication of an occlusal registration rim to create a wax denture try-in.



Mounting The Diagnostic Casts

To determine the distance between edentulous areas and opposing dentition, mount diagnostic casts utilizing the inter-occlusal records.

1. For partially edentulous arches, fabricate a diagnostic wax-up of the edentulous area using denture teeth or standard crown and bridge waxing techniques.
2. For fully edentulous arches, use an occlusal registration rim to make a bite registration, then create a patient-approved wax denture tooth try-in.



Duplicating The Diagnostic Wax-Up

Discuss surgical and restorative component options with the implant team prior to preparing the cast and wax-up for duplication.

Use an impression tray with alginate impression material to make an impression of the cast with incorporated wax-up of teeth and surrounding lost soft tissue. Fill the impression with stone and allow to harden.

Use the cast with diagnostic wax-up to fabricate a diagnostic, radiographic, surgical or alternatively a multi-function guide.



Fabricating The Clear Guide

Create a transparent guide using one of the following procedures:

1. A clear plastic 0.5 mm thick sheet is vacuum-formed over the duplicate stone cast of the tooth wax-up. Trim the guide according to clinical requirements. The vacuform can be used in its hollow version or using autopolymerizing or light cure acrylic to fill in areas previously occupied by wax and denture teeth.
2. Use a denture duplicator to create a clear version of the patient's current or new denture.



Placing The Radiographic Markers

Using metal radiographic markers when planning for a CT or similar type of scan is not recommended. Dimensionally calibrated metal ball bearings or an orthodontic wire will cause a sunburst or scatter effect rendering the scan unreadable.

Place material such as gutta percha or a mixture of radiographic powder (e.g., barium sulfate powder) and resin into pre-drilled diagnostic grooves or holes in the guide. The hole or markers should be placed inclusive of the incisal, cingulum or occlusal height of replacement teeth, taking into consideration the vacuform sheet thickness and the point in contact with the soft tissue. Metal markers can be used with standard scan procedures such as a panoramic or periapical.



Seating The Clear Guide

Place the guide with included radiographic markers into the patient's mouth, lock into position by engaging the undercut created by the height of contour of the surrounding natural teeth.

Make the required scan best suited for the proposed case design to acquire a working knowledge of the anatomical limitations in the areas of proposed implant placement.



Making The Required Measurements

The scan is used in conjunction with overlay templates of the implant design to plan the case. Radiographic markers can help the clinician determine:

- Height of the teeth to be replaced
- Thickness of the soft tissue (by subtracting the end of the marker from the start of the bone)
- Position of the restorative margin
- Number of implants
- Length of the implant
- Diameter of implant
- Inter-implant space



Trimming The Clear Guide

Remove the material from the radiographic/diagnostic guide in the area that is planned for surgery.

The clinician responsible for implant placement determines if they want vertical holes drilled or sections removed from the original guide to assist them in implant placement.



Fabrication Of A Diagnostic And Software-Based Surgical Guide

Fabricating The Diagnostic Guide/Scan Prosthesis

A scan prosthesis is generally a radiopaque duplicate of the provisional teeth set-up or patient's existing denture for visibility of the desired tooth location in the CT images and selected case planning software. Follow the software supplier's general scanning instructions including fabrication of the scan prosthesis, patient preparation, positioning, image reconstruction and scanning parameters.



Fabricating The Software-Based Surgical Guide

A software-based, case-specific surgical guide is fabricated by the software supplier or the dental laboratory.

For more guided surgery technique information, please reference Guided Surgery Instructions for Use P/N 8938 and pages 44-48 in this manual. For detailed surgical guide instructions for use please contact your software and/or surgical guide manufacturer.

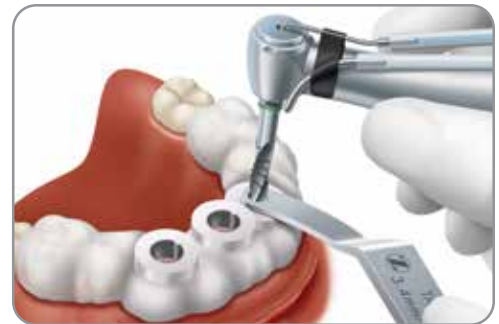

Implant Dimensions

Trabecular Metal Dental Implants*

Trabecular Metal Implants have a 0.5 mm machined or MTX microtextured coronal aspect, followed by 1.8 mm of the MTX Surface with microgrooves. The six microgrooves are circumferential with a depth of 0.06 mm and peak-to-peak width of 0.28 mm. Triple-lead threads begin 2.5 mm** from the top of the implant and continue to the apex with the exception of the Trabecular Metal Material mid-section. The degree of body taper varies between 1.5° and 2.0°, depending on implant length, to ensure that the apical diameter is consistent among all three implant lengths. Therefore, the shorter the implant, the greater the degree of taper.

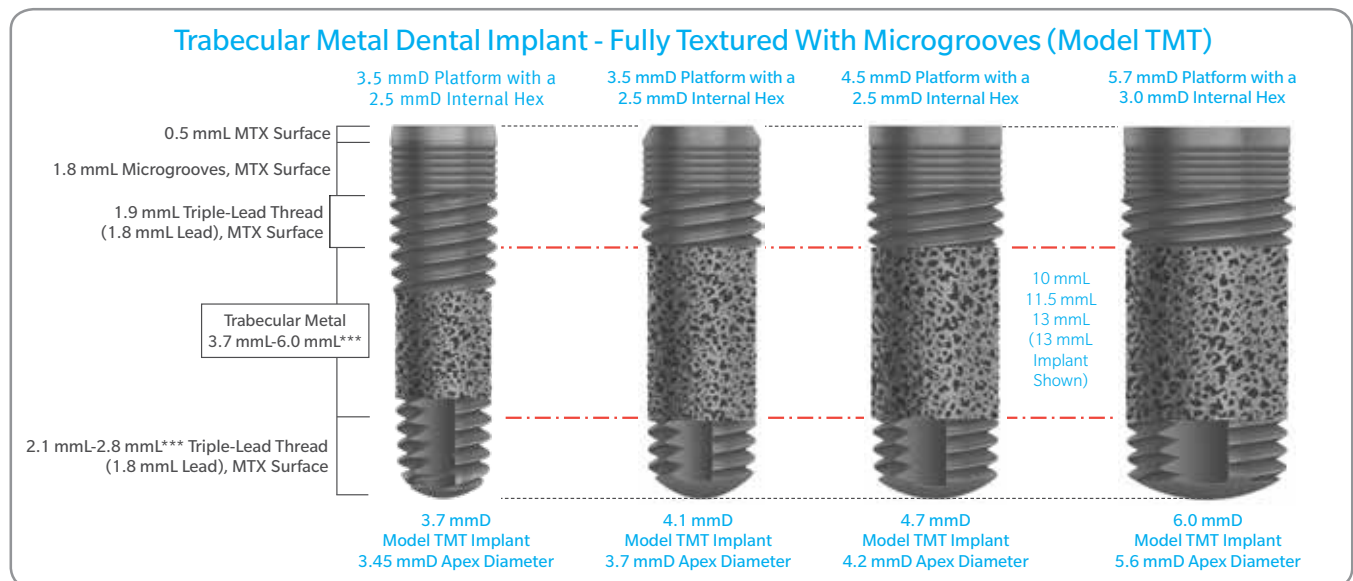
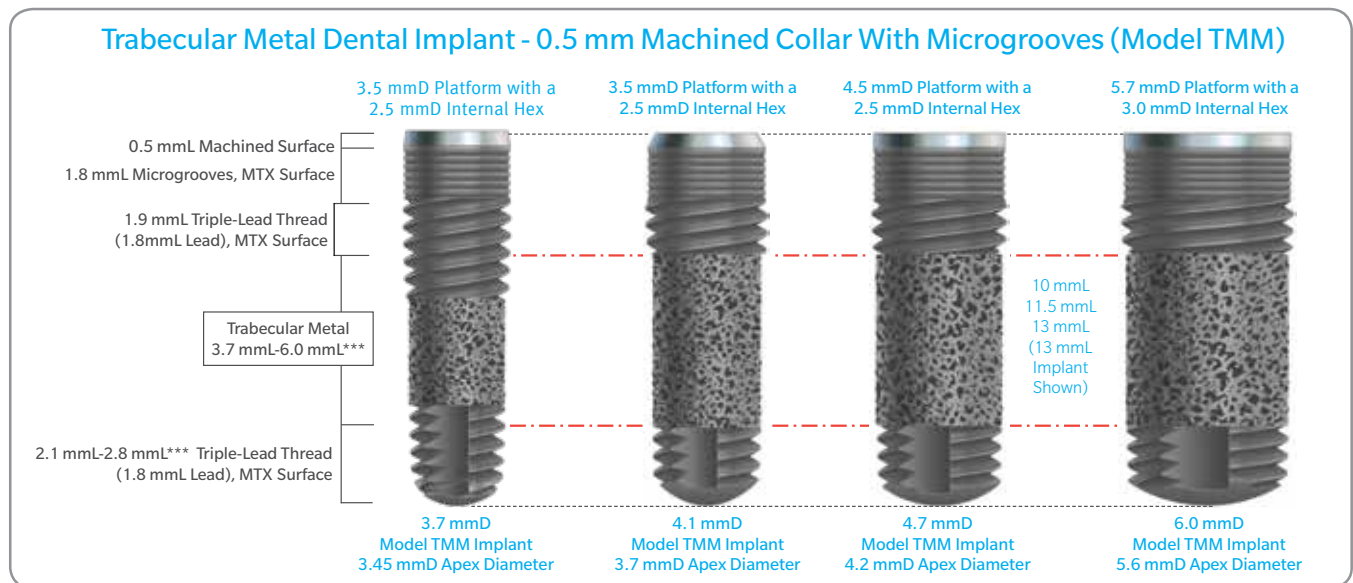

* Not available in all countries.

** Transitional space not included in the measurements noted in the schematic.

*** Dimension varies by implant length.

Implant Design And Specifications

Tapered Screw-Vent Implants

Tapered Screw-Vent Implants (Model TSV) feature a 1.0 mm machined coronal aspect followed by 1.5 mm of MTX Surface. Tapered Screw-Vent Implants taper along the length of the implant originating below the first thread, 3.5 mm from the coronal aspect of the implant. In the MP-1 HA-coated implants the HA coating begins at the first thread, 2.5 mm from the coronal aspect of the implant. The degree of taper on the implants varies between 1.0° and 4.0°, depending on their length, to ensure that the apical diameter is consistent among all five implant lengths. Therefore the shorter the implant, the greater the degree of taper.

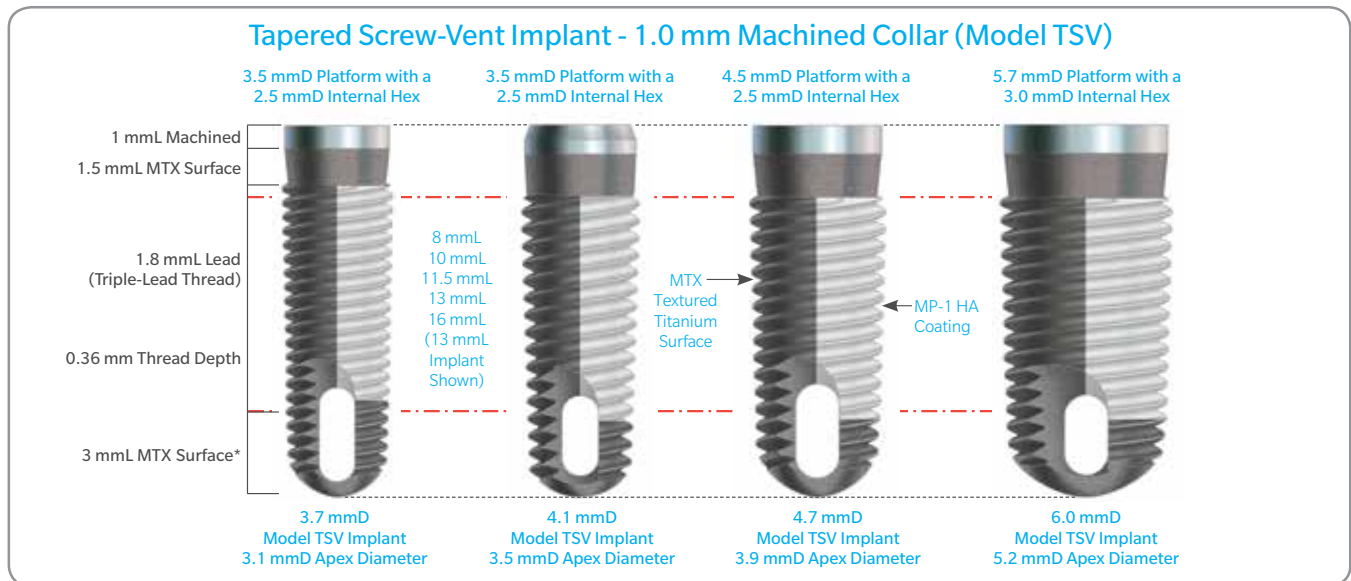

Tapered Screw-Vent Implants are available with additional coronal features. Tapered Screw-Vent Implants with 0.5 mm machined collar and crestal microgrooves (Model TSVM) maintains 0.5 mm of the same smooth machine texture as the traditional Tapered Screw-Vent Implant while extending the MTX surface texturing to the following 1.8 mm of microgrooves. The six microgrooves are circumferential with a depth of 0.06 mm and peak-to-peak width of 0.28 mm. Triple-lead threads begin 2.5 mm from the top of the implant and continue to the apex. The degree of body taper varies between 1.0° and 4.0°, depending on their length, to ensure that the apical diameter is consistent among all five implant lengths. Therefore the shorter the implant, the greater the degree of taper.

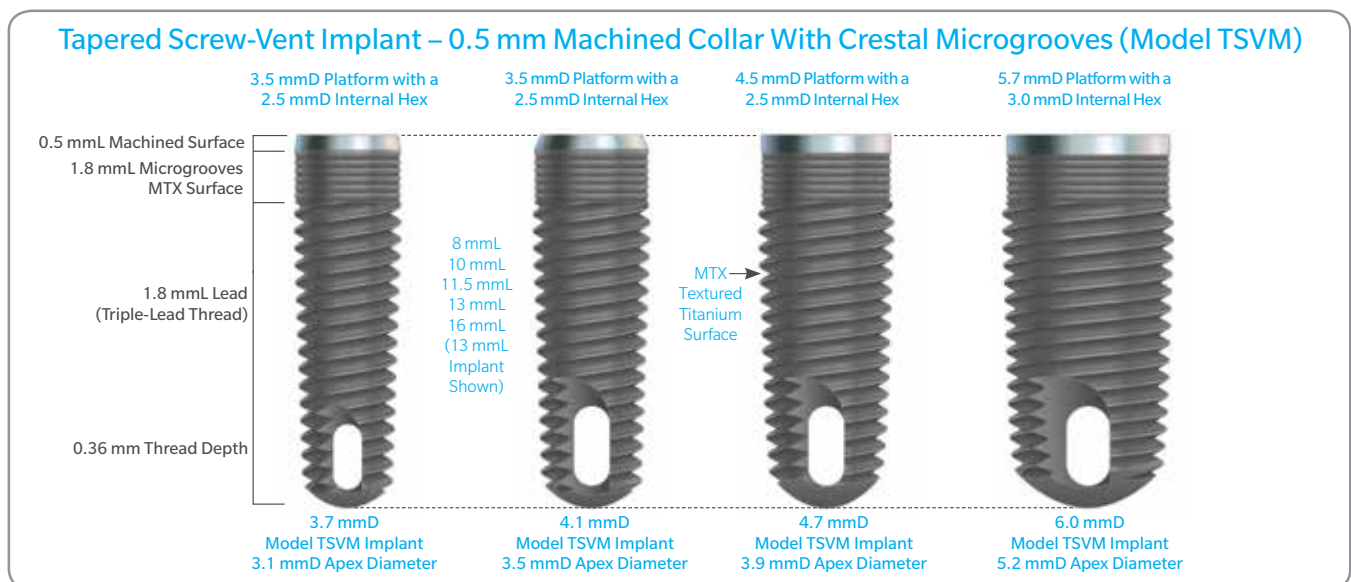

* On HA-Coated Implants, the 3 mmL apex has an MTX surface.

Tapered Screw-Vent Implant - Full Texturing And Crestal Microgrooves (Model TSVT)

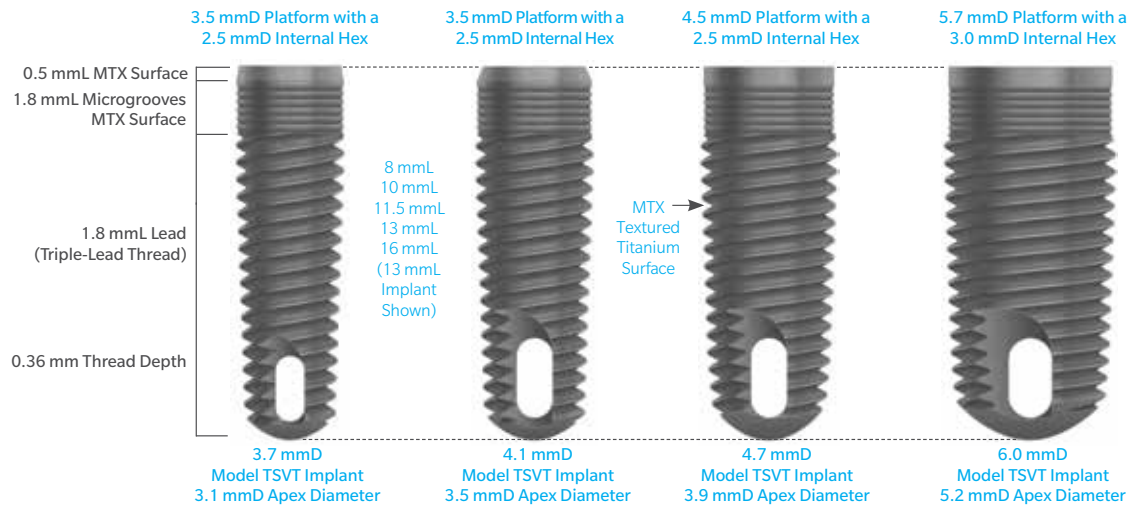

Platform Dimensions

The implant platform diameter is measured across the most coronal part of the implant. Trabecular Metal and Tapered Screw-Vent Implants have three implant platform diameters and designs:

- **3.5 mmD platform [Fig. 1A & B]** - A 44° internal lead-in bevel extends from the outermost diameter (3.5 mmD) of the implant platform into the internal hex of the implant. The internal hex configuration is 2.5 mmD flat-to-flat with a depth of 1.5 mm. Below the hexagon is a continuation of the inner chamber which leads into the threaded area where the appropriate fixation screw with 1-72 UNF thread is received.
- **4.5 mmD platform [Fig. 2A & B]** - A 44° internal lead-in bevel extends from the outermost diameter (4.5 mmD) of the implant platform into a flattened area or ledge. This ledge extends from the base of the lead-in bevel to the internal hex of the implant. The internal hex configuration is 2.5 mmD flat-to-flat with a depth of 1.5 mm. Below the hexagon is a continuation of the inner chamber which leads into the threaded area where the appropriate fixation screw with 1-72 UNF thread is received.
- **5.7 mmD platform [Fig. 3A & B]** - A 44° internal lead-in bevel extends from the outermost diameter (5.7 mmD) of the implant platform into a flattened area or ledge. This ledge extends from the base of the lead-in bevel to the internal hex of the implant. The internal hex configuration is 3.0 mmD flat-to-flat with a depth of 1.5 mm. Below the hexagon is a continuation of the inner chamber which leads into the threaded area where the appropriate fixation screw with 1-72 UNF thread is received.



Implant Design And Specifications

Crestal Options

Designed For Flexibility

Tapered Screw-Vent Implants are offered with and without crestal microgrooves and machined collar or texturing to the top to maximize flexibility in a variety of clinical conditions. Configurations available on select implants are shown below.

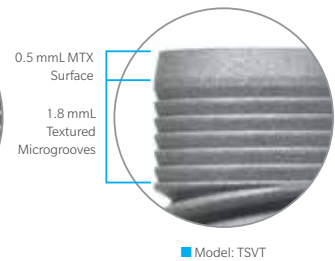
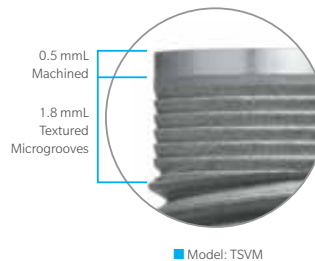
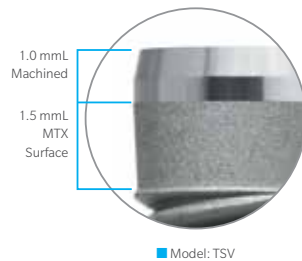

Materials

Biocompatibility And Strength

- Implants in the Tapered Screw-Vent Implant System are made of Grade 5 titanium alloy chosen for its biocompatibility¹ and strength.²⁻⁵
- Minimum tensile and yield strength requirements for this material, set by the American Society for Testing and Materials (ASTM) and the International Organization for Standardization (ISO), are 32% and 59% higher respectively than those of the strongest CP titanium available.²⁻⁵
- Zimmer Biomet specifications require that the Grade 5 titanium alloy used in Tapered Screw-Vent Implants meet or exceed the combined standards of ASTM and ISO.⁶



Surfaces

Documented MTX Surface Advantages

- High degree of bone-to-implant contact (BIC) and osteoconductive capacity.^{7,8}
- Successful clinical results under conditions of immediate loading.⁹⁻¹⁴
- Greater than 90% BIC as compared to 42-77% BIC achieved by TPS-coated, sandblasted and acid-etched, oxidized and HA-coated surfaces placed in grafted human sinuses.⁸



Documented MP-1 HA Coating Advantages

- Up to 97% crystallinity, reducing soluble phases and creating the potential to increase the coating's stability in vivo compared to HA coatings with lower crystallinity.^{6, 15}
- High degree of in vivo bone-to-implant contact (BIC)¹⁶

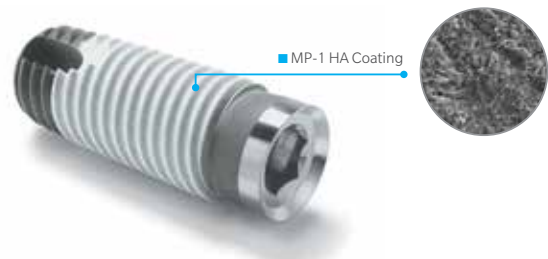

Implant Packaging

Trabecular Metal And Tapered Screw-Vent Implants

Remove the implant outer vial from the box.



Locate the patient record labels, indicating product description and lot number, and adhere to the patient's chart.



Open the outer vial to break the seal.



Drop the sterile inner vial and contents onto a sterile field.



Implant Design And Specifications



Flip the white top of the inner vial open by pressing on the flat side with access hole. Press the top to the inner vial body to lock in place.

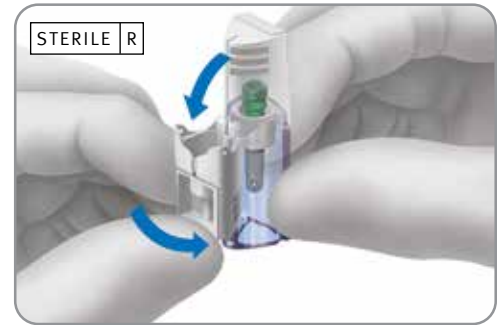

Place the appropriate insertion instrument over the end of the fixture mount.

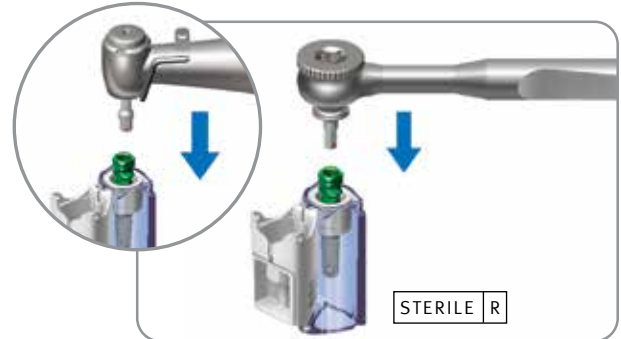

Engage the fixture mount with the insertion instrument.

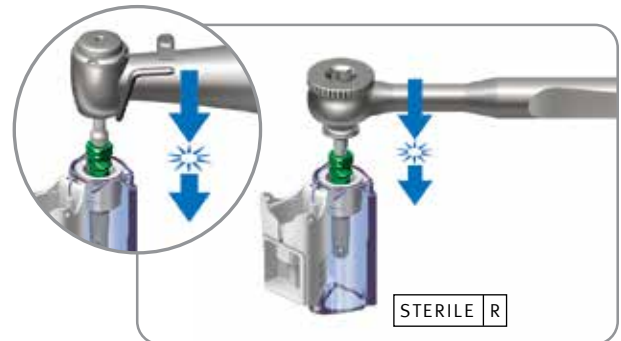

Lift the implant from the inner vial and carry it to the reception site. Initiate the implant into the osteotomy and complete seating with the appropriate instruments. After the implant is fully seated, remove the fixture mount with the 1.25 mmD Hex Driver with GemLock® retention [[HXGR1.25](#), [HXLGR1.25](#)].

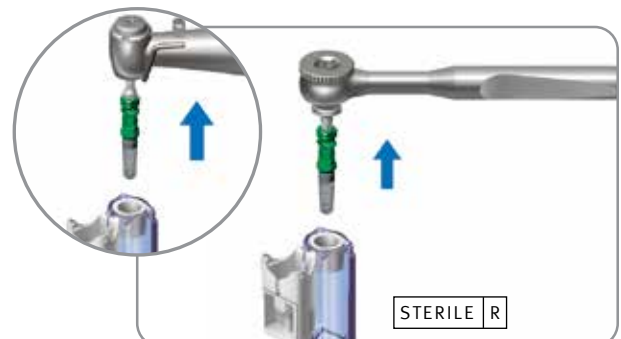

Locate the surgical cover screw in the cap of the inner vial. Using the 1.25 mmD Hex Driver with GemLock retention [HXGR1.25, HXLGR1.25], engage the cover screw.

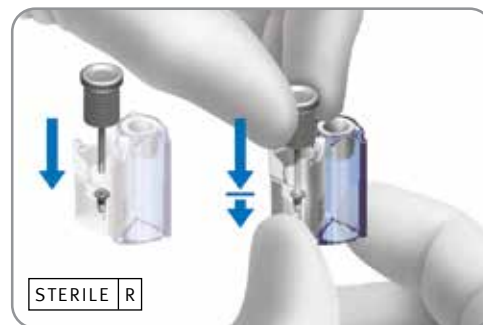

Engage the cover screw with the 1.25 mmD Hex Driver with GemLock retention [HXGR1.25, HXLGR1.25] and push down to open door. The surgical screw will be engaged.

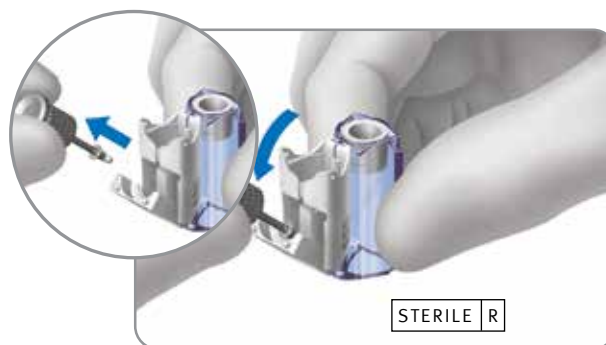

Instrument Kit System



Implant Color Reference Chart:

Trabecular Metal And Tapered Screw-Vent Implants

| Implant Diameter | 3.7 mmD | 4.1 mmD | 4.7 mmD | 6.0 mmD |
|--|-------------|-------------|-------------|-------------|
| Surgical Sequence Color Bar* | | | | |
| Drill Band Color for Dense-Bone Protocol | | | | |
| Implant Cap Color and Restorative Platform | 3.5 mmD | 3.5 mmD | 4.5 mmD | 5.7 mmD |
| Tapered Screw-Vent Vial Cap Label | | | | |
| Trabecular Metal Vial Cap Label NOTE: Yellow vial of Trabecular Metal Implant does not correspond to 5.7 mmD Platform | | | | |
| *NOTE: The surgical sequence for the 4.1 mmD Tapered Screw-Vent Implant is color-coded white on the surgical kit surface. The implant vial cap color remains green as an indication of the 3.5 mm prosthetic platform. | | | | |

Instrument Kit System



TSV Surgical Kit Layout Chart

Tapered Screw-Vent Surgical Kit

| | | | | | | | | | | |
|---|---|---|---|---|---|---|---|---|---|--|
| 1 3.0 mmD Round Bur 1203 | 2 2.3 mmD Drill, 22 mmL SV2.3DN | 3 Paralleling Tool (Qty: 4) PPAR | 4 2.8 mmD Drill, 22 mmL SV2.8DN | 5 3.4/2.8 mmD Step Drill, 22 mmL TSV3DN | 6 3.4 mmD Drill, 22 mmL SV3.4DN | 7 3.8/3.4 mmD Step Drill, 22 mmL TSV3.8DN | 8 3.8 mmD Drill, 22 mmL SV3.8DN | 9 4.4/3.8 mmD Step Drill, 22 mmL TSV4DN | 10 5.1 mmD Drill, 22 mmL SV5.1DN | 11 5.7/5.1 mmD Step Drill, 22 mmL TSV6DN |
| 12 Tapered Pilot Drill, 2.1/1.6 mmD, 8.0 mmL 0201 (0201DSN sold separately) | 13 2.3 mmD Drill, 16 mmL SV2.3DSN | 14 2.8 mmD Drill, 16 mmL SV2.8DSN | 15 3.4/2.8 mmD Step Drill, 16 mmL TSV3DSN | 16 3.4 mmD Drill, 16 mmL SV3.4DSN | 17 3.8/3.4 mmD Step Drill, 16 mmL TSV3.8DSN | 18 3.8 mmD Drill, 16 mmL SV3.8DSN | 19 4.4/3.8 mmD Step Drill, 16 mmL TSV4DSN | 20 5.1 mmD Drill, 16 mmL SV5.1DSN | 21 5.7/5.1 mmD Step Drill, 16 mmL TSV6DSN | |



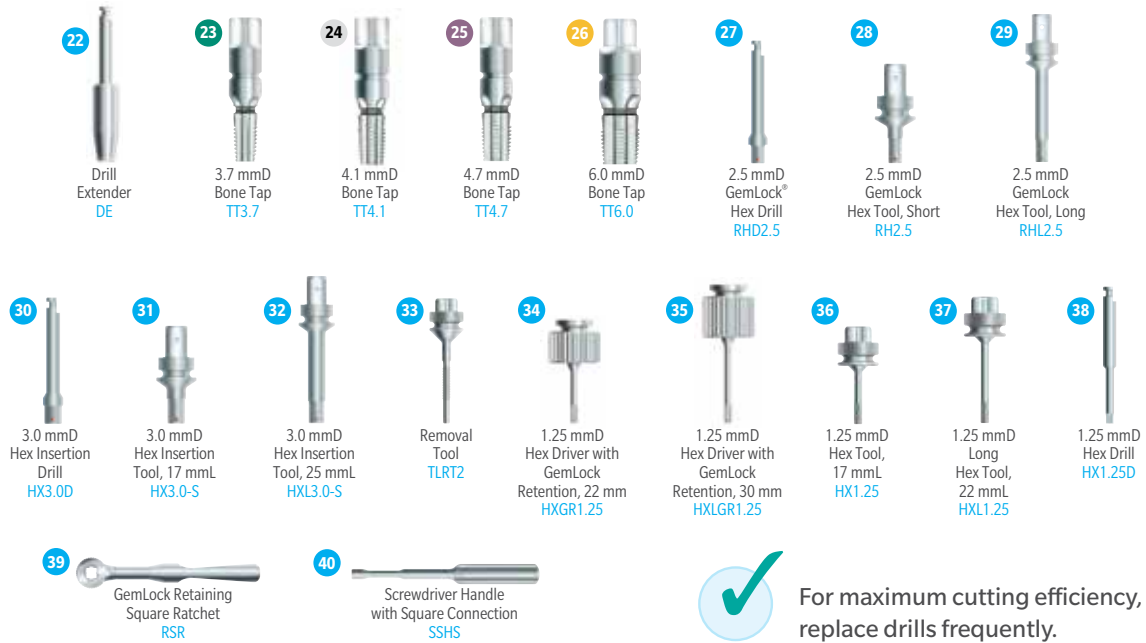

For maximum cutting efficiency, replace drills frequently.



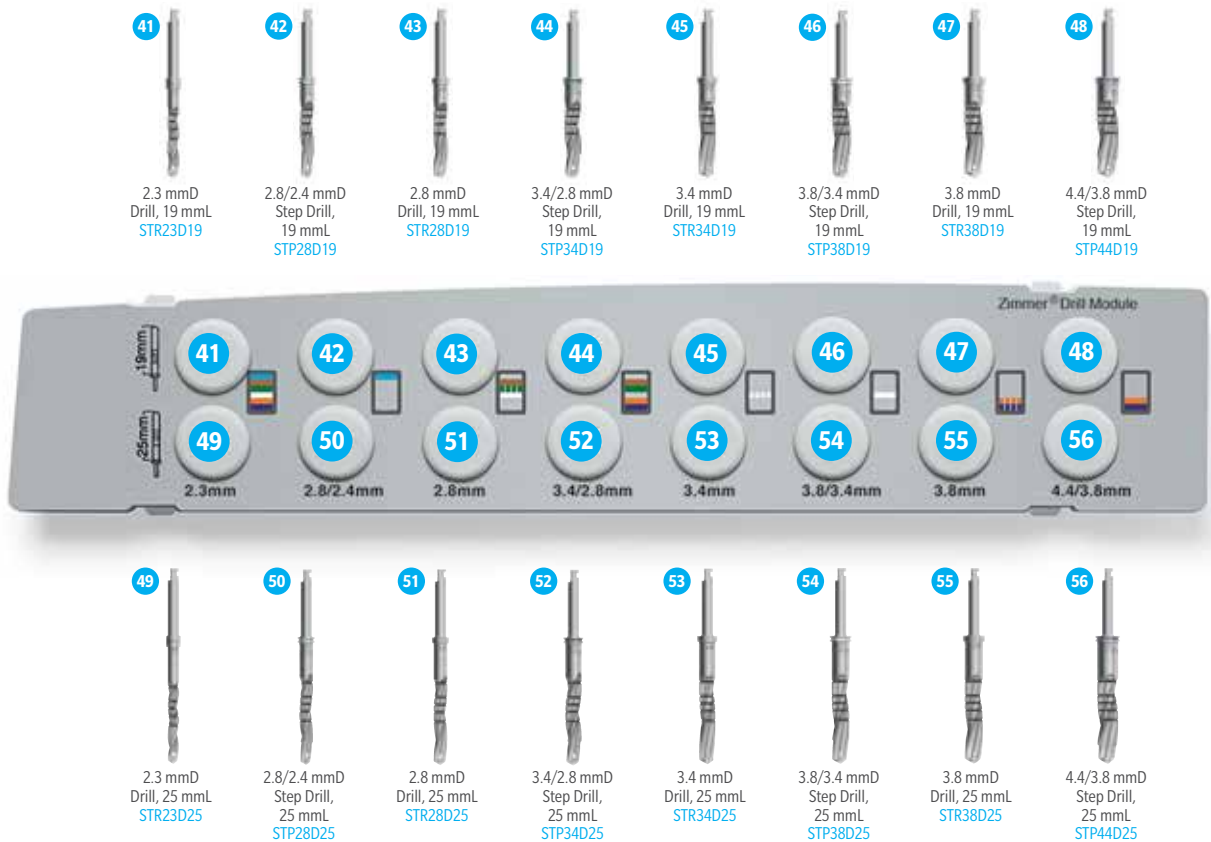







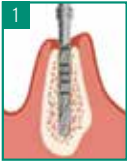
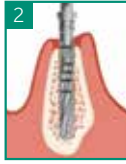

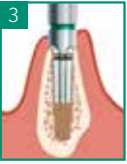

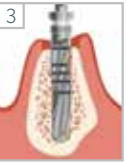
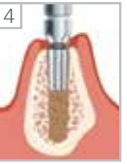

Guided Surgery Drill Module

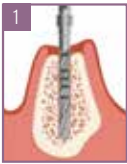
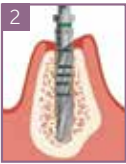

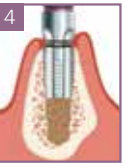
Instrument Kit System

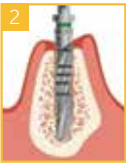

Drilling Sequence

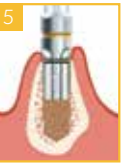
| | | | | | | |
|---|---|---|---|--|---|---|
|  <p>3.7 mmD</p> | <p>3.7 mmD Trabecular Metal and Tapered Screw-Vent Implant (3.5 mmD Platform)</p> | | | | <p>ATTENTION: Bone Tap for placement in dense bone.</p> <p>For detailed instructions, refer to the Instructions for Use provided with the TSV Instrument Kit System.</p> | |
| <p>1</p>  <p>SV2.3DN 2.3 mmD Drill</p> | <p>2</p>  <p>FOR SOFT BONE SV2.8DN 2.8 mmD Drill</p> | <p>2</p>  <p>FOR DENSE BONE TSV3DN 3.4/2.8 mmD Drill</p> | <p>3</p>  <p>OPTIONAL FOR DENSE BONE TT3.7 3.7 mmD Cortical Bone Tap</p> | | | |
|  <p>4.1 mmD</p> | <p>4.1 mmD Tapered Screw-Vent Implant (3.5 mmD Platform)</p> | | | | | <p>* When placing the 4.1 mmD Trabecular Metal Dental Implant in dense bone (Type D1), add an additional step utilizing the SV3.8DN/ SV3.8DSN drill after TSV3.8DN/TSV3.8DSN.</p> |
| <p>1</p>  <p>SV2.3DN 2.3 mmD Drill</p> | <p>2</p>  <p>SV2.8DN 2.8 mmD Drill</p> | <p>3</p>  <p>FOR SOFT BONE SV3.4DN 3.4 mmD Drill</p> | <p>3</p>  <p>FOR DENSE BONE* TSV3.8DN 3.8/3.4 mmD Drill</p> | <p>4</p>  <p>OPTIONAL FOR DENSE BONE TT4.1 4.1 mmD Cortical Bone Tap</p> | | |
|  <p>4.7 mmD</p> | <p>4.7 mmD Tapered Screw-Vent Implant (4.5 mmD Platform)</p> | | | | | <p>**In dense bone, an optional additional step drill may be used before TSV6DN/TSV6DSN: TSV5.1DN/TSV5.1DSN. Note this additional drill is sold separately and is not included in kits.</p> |
| <p>1</p>  <p>SV2.3DN 2.3 mmD Drill</p> | <p>2</p>  <p>TSV3DN 3.4/2.8 mmD Drill</p> | <p>3</p>  <p>FOR SOFT BONE SV3.8DN 3.8 mmD Drill</p> | <p>3</p>  <p>FOR DENSE BONE TSV4DN 4.4/3.8 mmD Drill</p> | <p>4</p>  <p>OPTIONAL FOR DENSE BONE TT4.7 4.7 mmD Cortical Bone Tap</p> | | |
|  <p>6.0 mmD</p> | <p>6.0 mmD Tapered Screw-Vent Implant (5.7 mmD Platform)</p> | | | | | |
| <p>1</p>  <p>SV2.3DN 2.3 mmD Drill</p> | <p>2</p>  <p>TSV3DN 3.4/2.8 mmD Drill</p> | <p>3</p>  <p>TSV4DN 4.4/3.8 mmD Drill</p> | <p>4</p>  <p>FOR SOFT BONE SV5.1DN 5.1 mmD Drill</p> | <p>4</p>  <p>FOR DENSE BONE** TSV6DN 5.7/5.1 mmD Drill</p> | <p>5</p>  <p>OPTIONAL FOR DENSE BONE TT6.0 6.0 mmD Cortical Bone Tap</p> | |

Surgical Drills

Updated Driva Drills and Guided Surgery Drill Module with additional length Driva EG Drills are required to interface with surgical guides and provide depth control. Please note that all four lengths of Driva drills are required to perform Guided Surgery procedures.

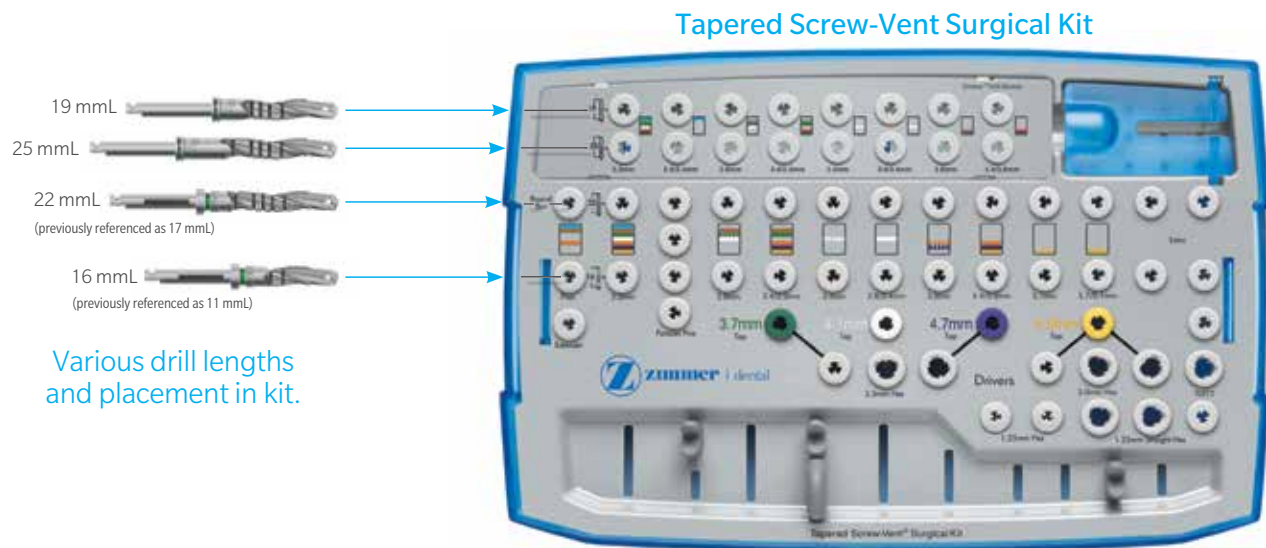

Guided Surgery Module

The Guided Surgery Drill Module with Driva EG Drills can be easily inserted into an existing Tapered Screw-Vent Surgical Kit to accommodate both traditional and guided procedures [Fig. 4].



NOTE: The design of the Driva Drills included in the Instrument Kit System have been updated to support compatibility with Guided Surgery Instrumentation. As shown above, the updated 16 mm and 22 mm drills can be identified by the addition of black vertical lines. Ensure that you have the updated 16 mm and 22 mm Driva Drills prior to utilizing Guided Surgery instrumentation, as only the updated Driva Drills are compatible. 19 mm and 25 mm drills are compatible with Guided Surgery Instrumentation. All four lengths of Driva drills are required to perform Guided Surgery procedures.

Instrument Kit System



Tube Adapter Kit

Tube Adapters [Fig. 5] fit in the tubes located inside the surgical guide to orient drills and provide positional and angulation control. Use Tube Adapter Diameter A when preparing the osteotomy for 3.0 mm or 3.7 mm diameter implants, and Tube Adapter Diameter B when preparing the osteotomy for 4.1 mm or 4.7 mm diameter implants. Tube Adapters may be used on the right or left side of the patient's oral cavity as both ends of each Adapter have identical-diameter holes.

Fig. 5

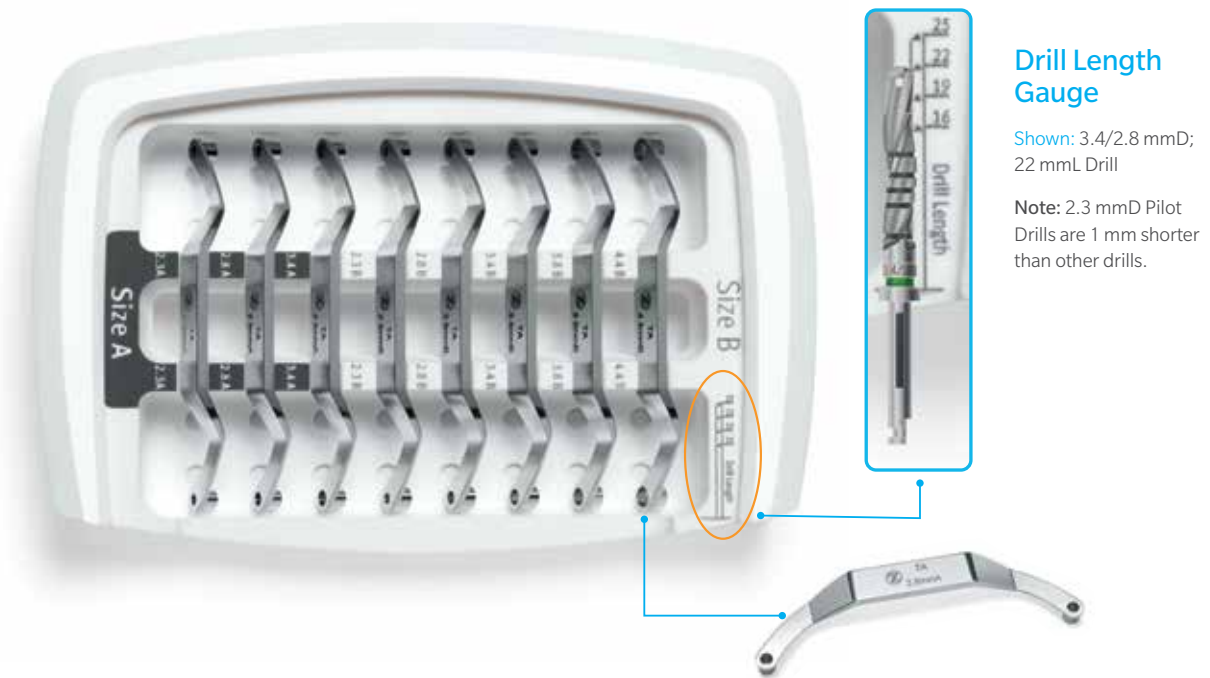

Driva Drills facilitate internal irrigation through the surgical guide [Fig. 6].



Fig. 6

Drill Stop Kit

The Drill Stops are used to limit drilling depth from bone level during osteotomy preparation for Tapered Screw-Vent Implants. The Drill Stops are made from Grade 5 titanium alloy.

Each Drill Stop Kit row is organized by length of implant being placed. Engraved on the Drill Stops are implant length indications. Indications followed by "L" correspond to the Driva Drill, 17 mm (22 mm). Indications followed by "S" correspond to the Driva Drill, 11 mm (16 mm). Each Drill Stop Kit column is organized by drill diameter. The Drill Stops are color-coded to correlate with drill diameters.



Instrument Kit System

Drill Stop Kit Instructions

Driva Drill Compatibility

The Drill Stops are designed for use with Driva Drills that have a black axial stripe (16 mmL and 22 mmL).

NOTE: Drill Stops in the last three rows of the 1st column labeled with implant diameter "2.3" for use with 11/16 mm Drills are also compatible with the [0201DSN] 2.1 mm/1.6 mmD Tapered Pilot Drill for limiting drilling depth to 8.0, 10 and 11.5 mm.



0201DSN

Selecting A Drill Stop

Sample Sequence – Osteotomy for a 3.7 mmD x 13 mmL Tapered Screw-Vent Implant, using a 17/22 mmL Driva Drill.

Step 1: From the 13 mmL implant row, select the stop for a 2.3 mmD Pilot Drill.

Step 2: From the same row, select the stop for a 2.8 mmD drill (final for soft bone) or skip to the stop for a 3.4/2.8 mmD Step Drill (final for dense bone).

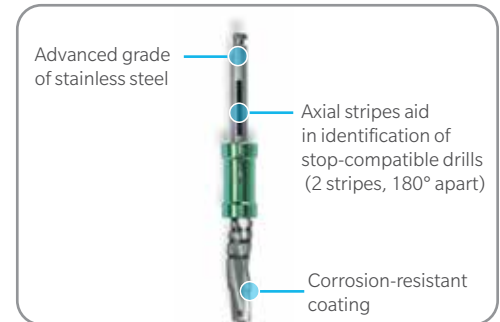

Placing The Drill Stop On The Drill

Insert the drill tip into the appropriate Drill Stop located in the Drill Stop Kit until firmly seated. Withdraw the drill with the Drill Stop on the drill.



Verifying The Drilling Depth

Verify the drilling depth with the assembled Drill Stop by using the Drill Depth Guide.

NOTE: The top of the laser/score line markings (0.5 mm in height) on the drills are in excess of the length of the implant to be placed by 1.25 mm (8.0 mmL is actually 9.25 mmL). This added length is to accommodate for the design of the drill point. The 2.3 mmD Drill is the only drill that is close to the actual implant length (i.e., 8.0 mmL is actually 8.25 mmL).



Creating The Osteotomy

Create the osteotomy to the pre-determined depth.

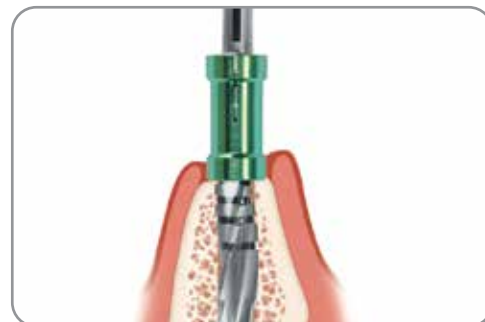

Removing The Drill Stop From The Drill

Disengage the Drill Stop using the Multi-Tool or by hand. Store used stops in the storage bowl.



Replacing The Drill Stop In The Kit

Following cleaning, and before placing the drill stop back in the kit, verify the Drill Stop's location in the kit by using the Drill Stop Guide.

NOTE: Replacement drill stops are available in case of loss or wear.



Surgical Procedures

General Surgical Instructions

Cleaning And Sterilization Guidelines

For detailed cleaning and sterilization instructions, please refer to the Instructions for Use (IFU) for each product. Disinfection and sterilization procedures should conform to OSHA or local guidelines for blood borne pathogens. Clinically contaminated implants should not be cleaned and resterilized under any circumstances. Improper cleaning could lead to inadequate sterilization.

Surgical instruments are susceptible to damage and wear and should be inspected before use. The number of uses per drill will vary and depends on a variety of factors including bone density encountered, proper handling and cleaning. Over time, repeat sterilizations may affect cutting efficiency and color appearance. Cutting edges should present a continuous edge and appear sharp. Check the latch-lock shank for wear to ensure the connection is not damaged. If inspection reveals signs of wear, damage, or unrecognizable color identification, replace the drill accordingly.

Cleaning

For automated cleaning instructions using the Dental Surgical Wash Tray (ZBDWT01)* in an automated washer/disinfector cleaning cycle, refer to IFU P-ZBDINSTRP, "Combination Cleaning and Disinfection Instructions for Instruments."

Drills, Instruments And Components - Disassemble multi-piece components, if applicable. Rinse with cool-to-lukewarm drinkable, tap water for two-and-one-half minutes. For Drills, use the cleaning wire to remove any debris from the irrigation channel. Using a 25 gauge needle, flush the drill lumen with water to remove any remaining debris. For all parts place in an ultrasonic cleaner with an enzymatic detergent diluted with tap water per the manufacturer's guidelines. Sonicate for 10 minutes. Rinse with drinkable, tap water for three minutes.

Kits, Trays And Blocks - Remove all parts and insert from the tray. Clean parts per the above instructions. Thoroughly rinse the kits under drinkable, tap water to remove all visible soil. Use a soft-bristle brush to clean the kits until all visible soil is removed. A syringe or pipe cleaner may be used to aid in the rinsing. Assure that all hard to reach areas are accessed. After the rinsing, prepare the enzymatic detergent following the manufacturer's specifications. Fully immerse the kit in the prepared detergent and allow the kit to soak in the detergent for a minimum of one minute. Following the soak use a damp cloth and/or a soft-bristle brush to wipe and remove any excess debris/soil from each component. A syringe or a pipe cleaner may be used to aid in the cleaning. Rinse the kits with lukewarm tap water to eliminate all residual enzymes

and detergent, thoroughly for a minimum of three minutes. Dry the components. Reassemble the contents of the kit and follow the guidelines for sterilization.

NOTE: This procedure should be performed after an instrument used during a surgery comes into contact with the kit.



*ZBDWT01 is available in select markets only.

Sterilization

When sterilizing individual parts, parts should be placed in sterilization pouch prior to sterilization. When sterilizing parts within a kit, parts should be placed in appropriate locations in the kit and the populated kit should be placed in sterilization pouch and sealed. The following validated sterilization parameters (method, time and temperature) are required to achieve a 10⁻⁶ sterility assurance level (SAL). Local or national specifications should be followed where steam sterilization requirements are stricter or more conservative than those listed in the table. Exceeding these sterilization parameters may result in damage to plastic components. Verify the calibration of your unit to ensure recommended temperatures are reached. To ensure autoclave is performing effectively, periodic use of biologic indicators should be considered. Chemiclave sterilization is NOT recommended. Store in the sterilization pouch until use.

| Cycle Type | Temperature | Exposure Time | Dry Time |
|--------------------|-------------|---------------|------------|
| Gravity (steam) | 132°C/270°F | 15 minutes | 20 minutes |
| Pre-vacuum (steam) | 132°C/270°F | 4 minutes | 20 minutes |
| Pre-vacuum (steam) | 134°C/273°F | 3 minutes | 20 minutes |
| Pre-vacuum (steam) | 134°C/273°F | 18 minutes | 20 minutes |

NOTE: For detailed cleaning and sterilization instructions, refer to the Instructions for Use for each product.



Surgical Procedures

Site Preparation

Making The Initial Incision

Make a mesiodistal incision along the alveolar crest through the mucoperiosteum and attached gingiva to the bone.

Flap and incision designs may vary due to clinician preference. Flapless surgery is only recommended when adequate bone quantity and quality have been established through appropriate diagnostic procedures.



Exposing The Implant Site

The incision should be long enough to permit adequate reflection and a broad field of view without tearing the tissue. Occasionally, vertical releasing incisions may be employed.

Using a periosteal elevator, carefully lift the periosteum to expose the alveolar bone only as necessary to provide an adequate surgical working area.

Place retractors or sutures to hold the soft tissues.



Removing Bone Irregularities And Assessing Implant Site

Remove any spinous ridges or other bone irregularities using the Round (Rosette) Bur [1203] or a Rongeur Forcep. Keep bone removal to a minimum. Insufficient bone height/width and abnormal defects or contours not previously detected may now contraindicate placement of the implant.

Maintain previously discussed requirements for ridge width and implant requirements.

Ridge contour should be adequately palpated to estimate an angle of insertion which will achieve parallelism with other implants and natural tooth abutments where indicated.



Using The Drill Extension

Use the drill extension when additional length is required due to interference caused by adjacent teeth. The Drill Extender [DE] extends the effective access of the cutting blade of the drill by 10 mm.

The drill extension has a standard latch-lock shank with a cylindrical shaft to accommodate the latch-lock type drill into the extension. The drill engages an anti-rotational flat and an O-Ring which holds the drill in position within the extender.

Do not use with drills other than the standard latch-lock type or exceed speeds of 850 rpm with the drill extension.

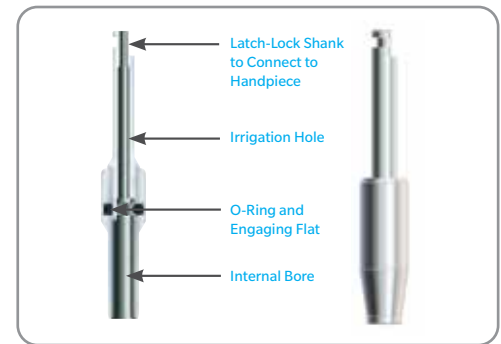

Marking The Implant Site

Seat the surgical guide in place to assist in marking the implant sites. The guide can be kept in place during the first stages of the drill sequence to help with the inclination as well as spacing of the implant sites relative to the proposed restoration.

Use copious external irrigation with the Round (Rosette) Bur [1203] and create a dimple through the dense ridge crest in the area of each proposed implant site. The dimple helps to prevent the surgical drills from drifting (chattering) from the proposed drill site.



Using The Surgical Drills

Reusable drills are designed to be used with both internal and external irrigation with a surgical unit that can supply a range of drilling speeds from 15-2000 rpm with sufficient torque. A recommended range for drilling is between 600-850 rpm, although clinicians may vary from this range in their protocol.

NOTE: The top of the laser/score line markings (0.5 mm in height) on the drills are in excess of the length of implant to be placed by 1.25 mm (8.0 mmL is actually 9.25 mmL). This added length is to accommodate for the design of the drill point. The 2.3 mmD Pilot Drill [SV2.3DN, SV2.3DSN] is the only drill that is close to the actual length (i.e., 8.0 mmL is actually 8.25 mmL).

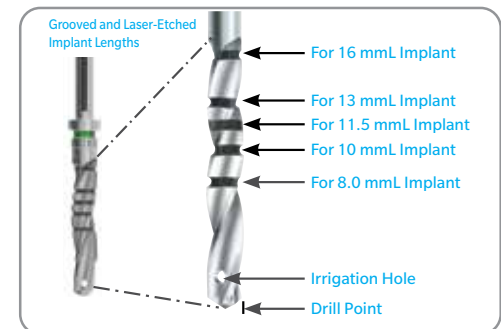

Using The Surgical Drills With Drill Stops

The Drill Stops in the Drill Stop Kit are used to limit drilling depth from bone level. Drill stop compatible drills are marked with black axial stripes. To place the Drill Stop on the drill, insert the drill tip into the appropriate Drill Stop located in the Drill Stop Kit until firmly seated. Withdraw the drill with the Drill Stop in place. Verify the drilling depth using the Drill Depth Guide on the kit. For additional information on the Drill Stop Kit, see pages 28-30.



Surgical Procedures

Initiating The Osteotomy

Perform all drill procedures with a straight up-and-down motion in order to avoid creation of an oval-shaped osteotomy. This pumping action in combination with copious irrigation will also help to minimize excessive heat generation and preserve the vitality of bone. The system should deliver an adequate flow of irrigation (40-100 ml/min) for a cooling, low-trauma surgical procedure.

NOTE: Use the hand piece designed for surgical motors only. This will ensure that compressed coolant air is not introduced to the surgical site.

Use the 2.3 mmD Drill to create a pilot hole to the depth of the implant to be used. Flush the hole to remove all debris.



Using The Paralleling Pin

The Paralleling Pin [PPAR] is designed with opposing ends having two diameters, 2.3 mmD and 2.8 mmD. This enables the clinician to use the pins in the first two steps of the drilling sequence to ensure correct placement and alignment of the implants.

Larger diameter drills should follow the path created by the 2.3 mmD and 2.8 mmD drills.

The 2.0 mmL score lines on the 2.8 mmD side of the Paralleling Pin can supply the clinician with an indication of height available for the restorative aspect of the procedure.

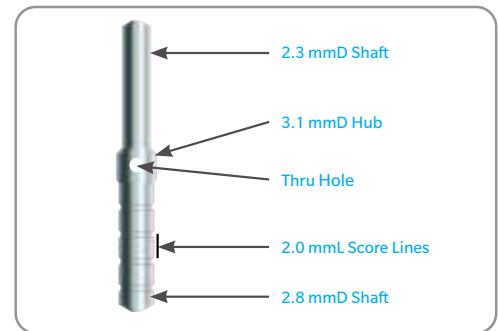

Inserting The Paralleling Pin

Thread floss through the hole in the middle of the pin for retention to prevent patient aspiration.

Insert the smooth side of the Paralleling Pin into the first 2.3 mmD osteotomy and confirm placement and alignment relative to the surgical guide.

Use the first pin as a guide and continue to drill the required sites to 2.3 mm diameter, inserting pins in each of the holes after they have been drilled and flushed to remove the debris.



Drilling The Osteotomy

Utilize the next drill in the drilling sequence for the implant diameter being placed to create an intermediate hole to the depth of the implant to be used. Utilize the 2.8 mmD side of the Parallel Pin when appropriate.

NOTE: Clean drill heads often to remove debris and ensure a sharp cutting surface. In conjunction with a cleaning wire [NM1940], a 25-gauge needle can be used to clean the drill's irrigation hole. A 30-gauge needle is required for drills that are 2.8 mmD or narrower. Due to the density of bone commonly found in the symphysis region, newer, sharp drills are recommended.



Intermediate And Final Sizing Of Osteotomies

Continue widening the osteotomy by following the appropriate drilling sequence for the implant diameter being placed, considering bone quality prior to selection of the final drill. (See drilling sequences on page 25).



Straight Drill For Soft Bone

Use the straight intermediate drills as the final drill when placing implants into soft bone according to the appropriate drilling sequence for the implant diameter being placed. (See drilling sequences on page 25 and additional information regarding soft- and dense-bone protocols on pages 7 and 38).



Stepped Drills For Dense Bone

Stepped drills for final sizing of the osteotomy are available when placing tapered implants in dense bone according to the appropriate drilling sequence for the implant diameter being placed (see drilling sequences on page 25). These drills are designed to accommodate the varying lengths of tapered implants without having to have length-specific tapered drills. The drill has two diameters of straight-walled design incorporated into one drill. This is designed to allow the implants to obtain maximum engagement into bone no matter the length of implant being used.

The length of the stepped area is approximately 5.0 mm from the point of the drill to the start of the wider portion. The stepped drills have color-coded bands based on implant color coding. (See color-coding charts on pages 21-22).

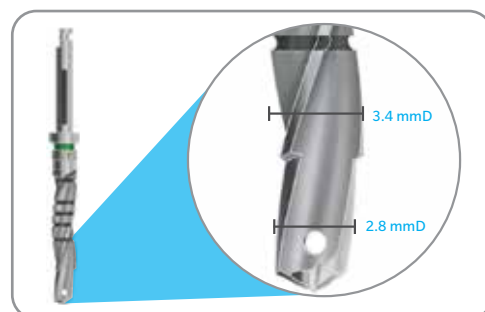

Surgical Procedures

Cortical Bone Taps

For placement of implants in dense cortical bone, bone taps are designed with a thread having the same configuration as the implant. Above the threaded area the tool flares out slightly to open the cortical plate to receive the wider neck of the implant.

Cortical bone taps may be utilized to reduce insertion torque when placing implants in dense cortical bone. Above the threaded area the tool flares out slightly to open the cortical plate to receive the wider neck of the implant.

Typically, taps are only advanced through the dense cortical plate, however, the laser-etch line indicates the maximum tap depth.

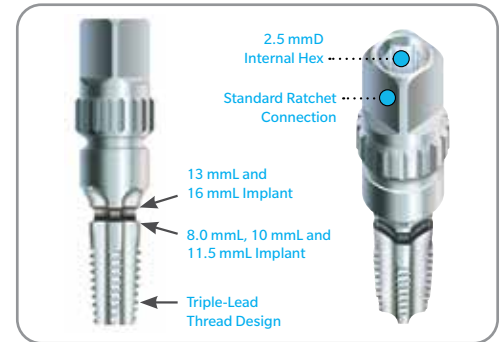

Using Cortical Bone Taps

Use the Cortical Bone Tap in conjunction with the GemLock Retaining Square Ratchet [RSR] and rotate into the osteotomy.

In areas where there is limited space between the surrounding dentition, a 2.5 mmD GemLock Hex Tool [RH2.5, RHL2.5] can be inserted into the back end of the Cortical Bone Tap to increase the vertical height of the tool allowing attachment of the ratchet. A 2.5 mmD Hex Drill [RHD2.5] can also be inserted into the recess to facilitate use with a high-torque, low-speed (15 rpm) surgical handpiece and motor.

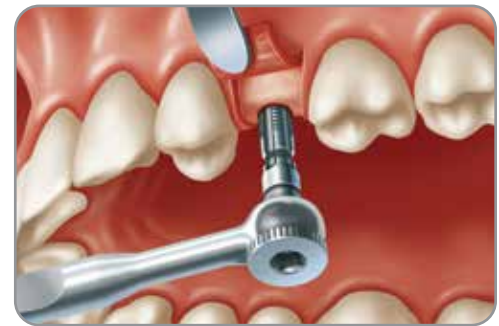

Preparing For Implant Placement

Irrigate the implant sites with sterile water and then suction prior to implant placement, ensuring no debris is left at the base or attached to the vertical walls of the osteotomy.

Any debris could hinder the vertical placement of the implant as well as possibly increase the insertion torque above acceptable limits.



Soft- And Dense-Bone Protocols

Final Sizing Of Osteotomy

Drill the osteotomy according to the density of the bone surrounding the proposed implant site.

In areas where the bone is commonly referred to as soft bone, it is often advocated to stop the drilling sequence at the straight drill before the final step drill.

Soft-bone protocol: 2.8 mmD straight drill for 3.7 mmD implants, 3.4 mmD for 4.1 mmD implants, 3.8 mmD for 4.7 mmD implants and 5.1 mmD for 6.0 mmD implants.

Dense-bone protocol: 3.4/2.8 mmD stepped drill for 3.7 mmD implants, 3.8/3.4 mmD for 4.1 mmD implants, 4.4/3.8 mmD for 4.7 mmD implants and 5.7/5.1 mmD for 6.0 mmD implants. Use of the bone tap is optional but may be necessary in very dense bone.

Placing Implant Into Osteotomy

Soft-bone protocol: From time of initial placement of the implant in the straight hole, the implant will start to compress the bone. This occurs due to the fact that the hole size is slightly smaller than the apex size of the implant. Example: Using the 3.7 mmD implant with a 3.0 mmD apex and inserting into a hole with a 2.8 mmD opening.

Dense-bone protocol: From time of initial placement of the implant in the stepped hole, the implant will drop almost a third of its length before stopping. This occurs because the hole size is bigger than the apex size of the implant. Example: Using the 3.7 mmD implant with a 3.0 mmD apex and inserting into a 3.4 mmD opening.

Placing Implant Into Osteotomy, Close Up

Soft-bone protocol: Compression of bone occurring from time of initial insertion.

Dense-bone protocol: Implant drops into hole almost a third of its thread length at time of initial insertion. The Fixture Mount/Transfer may be removed and the GemLock Hex Tool [RH2.5] used to directly engage the implant for insertion with the screwdriver handle [SSHS].

Completing Placement Of Implant

Soft-bone protocol: Compression of bone occurring the full length of the implant, improving initial stability from time of placement.

Dense-bone protocol: As the implant progresses, the thread will engage the walls of the osteotomy. When fully seated the 3.7 mmD apical end of the implant, will engage the 3.8 mmD section of the osteotomy. The amount of engagement will increase over the length of the implant to the 4.7 mmD coronal threads engaging the 4.4 mmD section of the osteotomy. The inner dimension (4.4 mmD maximum) of the implant threaded area contacts the walls of the osteotomy, but does not compress. (Measurements refer to 4.7 mmD implant sequence).

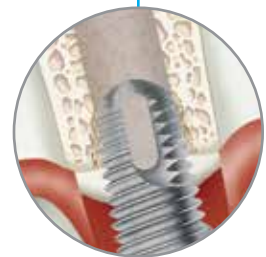

Surgical Procedures

Implant Placement

Removing The Implant From The Vial

Remove the implant outer vial from the box and open the outer vial to break the seal. Drop the sterile inner vial and contents onto a sterile field. Flip the white top of the inner vial open by pressing on the flat side with access hole. Press the top to the inner vial body to lock in the top. For further instructions see the Packaging Instructions for Use on pages 18-20.

The implant is supplied pre-attached to a multi-functional Fixture Mount/Transfer for easy delivery. Remove the implant from the inner vial by using one of the delivery instruments (see the next section).

NOTE: The supplied Surgical Cover Screw is located in the lid of the inner vial with an access hole for the GemLock Hex Tool.

Delivering The Implant To The Site

The implant may be driven manually or with the use of a surgical motor at speeds up to 30 rpm. The following instruments can be used for implant delivery to the site:

1. The GemLock Ratchet Retaining Square [RSR] or the Screwdriver Handle [SSHS] attached directly to the Fixture Mount/Transfer.
2. The GemLock Ratchet Retaining Square [RSR] attached to the 2.5 mm GemLock Retaining Hex Drivers [RH2.5, RHL2.5] which engage the female hexagon of the Fixture Mount/Transfer.
3. The GemLock Ratchet Retaining Square [RSR] attached to the 2.5 mm GemLock Retaining Hex Drivers [RH2.5, RHL2.5] or the 3.0 mm Hex Driver [HX3.0-S, HXL3.0-S] inserted directly into the implant when space is limited or to facilitate placement in dense bone.
4. A motor handpiece attached to the 2.5 mm GemLock Retaining Hex Driver [RHD2.5] for placement with the Fixture Mount/Transfer or for placement of an implant with a 2.5 mmD internal hexagon without the Fixture Mount/Transfer, or the 3.0 mm Hex Driver [HX3.0D] for placement of an implant with a 3.0 mmD internal hexagon.

NOTE: The 2.5 mm GemLock Hex Tools and Hex Drill engage the female hexagon of the Fixture Mount/Transfer or the 2.5 mm internal hexagon implants directly (Tapered Screw-Vent Implants). The 3.0 mm GemLock Hex Drivers and Drill directly engage the 3.0 mm internal hexagon implants (Tapered Screw-Vent Implants) only.

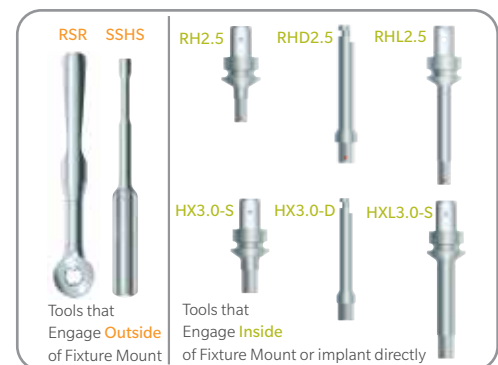
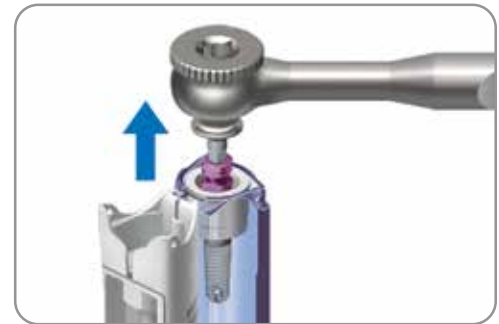

Inserting And Orienting The Implant

Gently seat the implant into the osteotomy. The tapered implants will seat into the osteotomy as described on the previous page. Thread the implant into the prepared site using the GemLock Retaining Square Ratchet [RSR] attached to the fixture mount or by utilizing an alternative method as described above.

The flat side of the Fixture Mount/Transfer is manufactured to align with the flat of the implant's hex. To ensure proper orientation of the Hex-Lock Contour Abutments, align the flat side of the Fixture Mount/Transfer to the buccal aspect. For 20° Abutments, orient a flat side of the Fixture Mount/Transfer toward the direction of the implant angle.



Completing Implant Insertion

After the implant is seated in the desired position, use the 1.25 mmD GemLock Hex Driver [HXGR1.25, HXLGR1.25] to unthread the Fixture Mount Screw. If unable to unthread, seat the ratchet over the Fixture Mount and use it as a counter-torque. Insert the 1.25 mmD GemLock Hex Driver through the ratchet and loosen the screw. Disengage the Fixture Mount and Screw from the implant by gently pulling up in an axial direction.

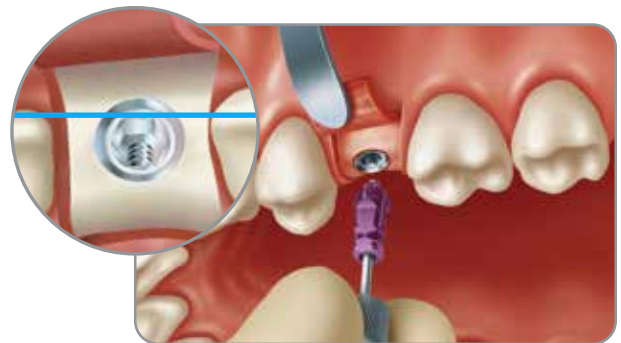

Cleaning The Surgical Site

Irrigate the surgical site with sterile water and then suction, ensuring the implant's internal chamber is clear of bone and tissue debris and/or blood. This procedure will allow for the unimpeded seating of the Surgical Cover Screw, Healing Collar or Provisional Abutment.



Surgical Procedures

Two-Stage and One-Stage Protocols

Surgical Options: Two-Stage or One-Stage Healing

In a traditional two-stage protocol, the surgical cover screw is threaded into the implant over which the tissue is sutured during implant healing. To select the surgical cover screw, unthread the surgical cover screw from its plastic mount in the lid of the inner implant vial. Use the 1.25 mmD Hex Driver with GemLock retention [HXGR1.25, HXLGR1.25] to engage the surgical cover screw through the access hole. Press the Hex Driver to the side to open the white flap of the lid and retrieve the surgical cover screw. Continue with the following steps on this page.

For a one-stage procedure, depending on initial implant stability and the overall treatment plan, a healing collar or provisional abutment is placed around which the tissue is sutured (See page 49 “Healing Collar Selection Guide,” for instruction regarding Healing Collar Selection — If a healing collar is used in a one-stage procedure, after the appropriate healing time has elapsed continue with step “Removing the Healing Collar” on page 43).

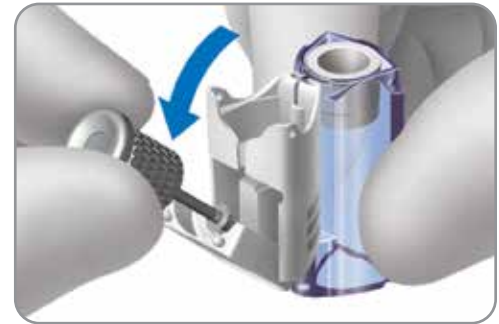

Two-Stage: Placing The Surgical Cover Screw

Use the 1.25 mmD Hex Driver with retentive GemLock feature [HXGR1.25, HXLGR1.25] to carry the Surgical Cover Screw to the opening of the implant. Gently thread the screw into the implant ensuring proper thread engagement between the two components.

Tighten using finger pressure only. The Surgical Cover Screw should fit flush with the top of the implant. This will provide a low profile, often level with the crest of the ridge. This low profile is advantageous when primary soft-tissue closure is desired.

After placement of the implant and Surgical Cover Screw, take a radiograph to confirm position before closure of the soft tissue.



Two-Stage: Suturing The Soft-Tissue

Carefully replace the soft tissue over the Surgical Cover Screws. Use suture material of choice and suture with one or more of the suture methodologies available (interrupted sutures shown).

Instruct the patient to follow post surgical maintenance and hygiene. Provide a provisional prosthesis that is designed to prevent any premature loading on the implants.

Remove the sutures after 1 to 2 weeks.



Two-Stage: Removing The Provisional Prosthesis

Through x-ray analysis and knowledge of bone density in the surgical area, determine the time for second-stage surgical procedures.

Remove the provisional prosthesis.



Two-Stage: Locating The Surgical Cover Screw

Locate the position of the Surgical Cover Screw by palpation of the soft tissue or with the use of a periodontal probe.



Two-Stage: Exposing The Surgical Cover Screw

Expose the Surgical Cover Screw by using a Tissue Punch or a scalpel.



Two-Stage: Removing The Surgical Cover Screw

Remove any bone growth from the superior aspect of the Surgical Cover Screw. Care must be taken not to damage the implant during the process of bone removal.

Use the 1.25 mmD Hex Driver with GemLock retention [[HXGR1.25](#), [HXLGR1.25](#)] in a counter-clockwise direction to remove the Surgical Cover Screw.

The implant can now be evaluated to determine if it is sufficiently anchored in the surrounding bone.



Surgical Procedures

One-Stage Or Two-Stage: Seating The Healing Collar

Utilize the "Healing Collar Selection Guide" on page 49 for instruction regarding Healing Collar Selection. Irrigate the surgical site with sterile water and then suction, ensuring the implant's internal chamber is clear of bone and tissue debris and/or blood. This procedure will allow for the unimpeded seating of the Healing Collar and complete closure of the implant's internal chamber and prosthetic interface.

Thread the Healing Collar into the implants with a 1.25 mmD Hex Driver with GemLock retention [HXGR1.25, HXLGR1.25] and then use finger pressure to tighten.



One-Stage Or Two-Stage: Suturing The Soft-Tissue

Carefully replace the soft tissue around the Healing Collar. Use suture material of choice and suture with one or more of the suture methodologies available (interrupted sutures shown).

Instruct the patient to follow post surgical maintenance and hygiene. Provide a provisional prosthesis that is designed to prevent any unguided loading on individual implants (i.e., the occlusal load is shared with all implants and/or surrounding dentition equally).

Remove the sutures after 1 to 2 weeks.

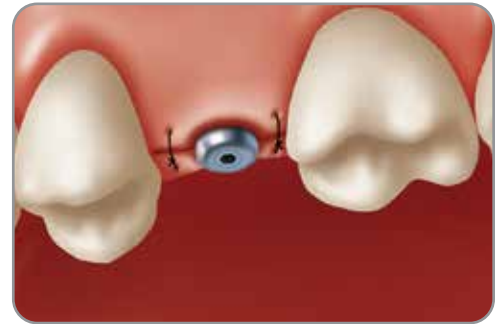

One-Stage Or Two-Stage: Removing The Healing Collars

In a two-stage procedure, use the 1.25 mmD Hex Driver with GemLock retention [HXGR1.25, HXLGR1.25] to remove the Healing Collars after a satisfactory soft-tissue healing period, to be determined on a case by case basis.

If a one-stage protocol was utilized, remove the Healing Collar (or immediate provisional restoration) after the appropriate implant healing period.

The implants are now ready for the restorative phase of the implant procedure.



One-Stage Or Two-Stage: Measuring Soft-Tissue Depth

Use a periodontal probe with 1.0 mm demarcation lines to measure the buccolingual and mesiodistal soft-tissue depth. Measurements are taken from the superior aspect of the implant to the gingival margin. Measurements will assist in determining the height of the abutment required for the restoration. Refer to the Trabecular Metal and Tapered Screw-Vent Implant Restorative Manual, for further restorative instructions.



Guided Surgery

Select Drills and Tube Adapters following the protocol provided by the surgical guide manufacturer. The predetermined drilling depth is achieved by the combination of custom guide height and appropriate drill length selection, indicated by the guide manufacturer. Drill flange will stop on the top of the Tube Adapter when a desired depth is achieved.

NOTE: Verify drill length with the Drill Length Gauge on the Tube Adapter Kit (See page 27).

Sample Surgical Protocol For Trabecular Metal/TSV Guided Surgery Instrumentation

Example below: Surgical protocol example for a tooth-supported guide - three TSV Implants in mandible (tooth #23, #25, #27).

| 1 | Tooth Number | 23 | 25 | 27 |
|----|-----------------------|-----------------|-----------------|-----------------|
| | Implant Information | | | |
| 2 | Implant Part Number | TSVB16 | TSVB11 | TSVWB13 |
| 3 | Implant Diameter (mm) | 3.7 | 3.7 | 4.7 |
| 4 | Implant Length (mm) | 16 | 11.5 | 13 |
| 5 | Depth Control | Yes | Yes | Yes |
| | Surgical Sequence | | | |
| 6 | Tube Adapter | 2.3 A | 2.3 A | 2.3 B |
| 7 | Drill | 2.3 (22 mm) | 2.3 (19 mm) | 2.3 (19 mm) |
| 8 | Tube Adapter | 2.8 A | 2.8 A | 3.4 B |
| 9 | Drill | 2.8 (22 mm) | 2.8 (19 mm) | 3.4/2.8 (19 mm) |
| 10 | Tube Adapter | 3.4 A | 3.4 A | 3.8 B |
| 11 | Drill | 3.4/2.8 (22 mm) | 3.4/2.8 (19 mm) | 3.8 (19 mm) |
| 12 | Tube Adapter | • | • | 4.4 B |
| 13 | Drill | • | • | 4.4/3.8 (19 mm) |

NOTE: The instrument selection protocol and appearance may differ depending on the case planning software. For detailed information about location of the instruments in the surgical kits, please reference pages 23-27 of this manual. For detailed Guided Surgery technique information, please reference the Guided Surgery Instructions for Use, P/N 8938. For detailed surgical guide instructions for use please contact your software and/or surgical guide manufacturer.

Sample Surgical Protocol For Guided Surgery Instrumentation

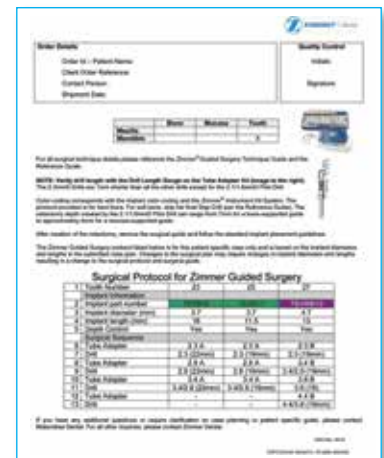

Surgical Procedures

Guided Surgery Instructions

Treatment Planning

Clinician performs the clinical exam and takes patient records and diagnostics. Overall restorative treatment plan for the desired restorative outcome is developed in conjunction with the implant team. If required, patient is referred to the surgical specialist for further evaluation.



Scan Prosthesis

Dental laboratory or clinician fabricates a scan prosthesis — generally a radiopaque duplicate of the provisional teeth set-up or patient's existing denture — for visibility of the desired tooth location in CT images and selected case planning software.



CT Scan

Patient undergoes CT scan (wearing the scan prosthesis), according to the software supplier's general scanning instructions — including patient preparation, positioning, image reconstruction, and scanning parameters.



Surgical Case Planning

The CT scan data is converted into a format that allows it to be utilized by the selected case planning software, or is imported directly. The case is then planned in the treatment planning software.



Surgical Guide And Protocol

The software supplier or dental laboratory fabricates the case-specific surgical guide compatible with Guided Surgery Instrumentation. The guide manufacturer delivers the surgical guide, along with the surgical protocol for each Trabecular Metal or Tapered Screw-Vent Implant site preparation.



Surgical Protocol Summary

Surgical protocol for Guided Surgery Instrumentation provides detailed information regarding proper Drill sequence and Tube Adapter selection for the surgical preparation of each implant site.

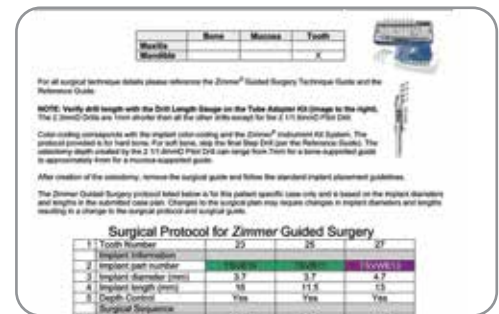

Surgical Guide Placement

The tooth-, mucosa-, or bone-supported surgical guide is fixed to the surgical site. Commercially available fixation pins may be utilized for a mucosa-supported guide.

Shown: A tooth-supported surgical guide with elevated flap.



Surgical Procedures

Guided Surgery Instrumentation

Referencing the case-specific surgical protocol provided with the surgical guide, follow the sequence of Tube Adapters and Surgical Drills to prepare the implant osteotomy.

The Tube Adapter fits inside the titanium tube insert in the surgical guide. Tube Adapters — used in conjunction with the Drills and length-specific surgical guides — provide positional, angulation and depth control, and are labeled for easy identification. Tube Adapters can be used on the patient's left- or right-hand side as the holes on both sides are identical in diameter.



Sample Surgical Sequence

The following steps detail the surgical sequence for the example case shown in the surgical protocol on page 44: an osteotomy for a 3.7 mmD x 16 mmL Tapered Screw-Vent Implant in tooth location #23, in dense bone.

Tube Adapter Selection

Following the surgical guide protocol, select the initial Tube Adapter 2.3 A (2.3 mmD; size A) from the Tube Adapter Kit. Place the Tube Adapter into the guide tube on the most convenient side.



Drill Selection

Select the initial Drill from the protocol – 2.3 (22 mm), (2.3 mmD; 22 mmL). Verify Drill length of 22 mm with the Drill Length Gauge on the Tube Adapter Kit.

Shown: 3.4/2.8 mmD; 22 mmL Drill.

NOTE: 2.3 mmD Pilot Drills are 1mm shorter than other Drills.



Initiating The Osteotomy

Drill to initiate an osteotomy through the Tube Adapter until the Drill flange stops on top of the Tube Adapter. The predetermined drilling depth is achieved by the combination of custom guide height and appropriate Drill selection, indicated in the guide manufacturer's protocol.



Expanding The Osteotomy

Remove the Tube Adapter 2.3 A and place the next Tube Adapter 2.8 A into the guide tube opening. Use the next Drill in the sequence, 2.8 (22 mm), to expand the osteotomy through the Tube Adapter until the Drill flange stops on top. Verify Drill length of 22 mm with the Drill Length Gauge on the Tube Adapter Kit.

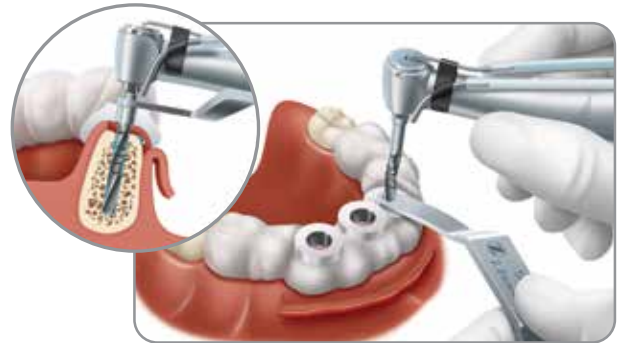

Remove the Tube Adapter 2.8 A and place the next Tube Adapter 3.4 A into the guide tube opening. Select the next Drill in the sequence, 3.4/2.8 (22 mm). Following Drill length verification with the Drill Length Gauge, expand the osteotomy through the Tube Adapter until the Drill flange stops on top.



Placing The Implant

Remove the surgical guide and follow standard implant placement guidelines.

Optional: Use of the 3.7 mmD Cortical Bone Tap may be required in dense bone.

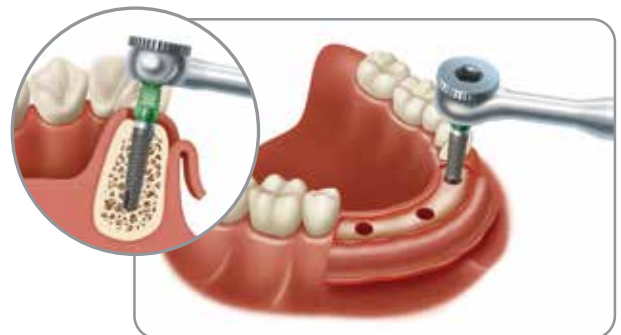

Surgical Procedures

Healing Collar Selection

TSV™ BellaTek® Encode® Healing Abutments

The TSV BellaTek Encode Healing Abutment is a two-piece healing abutment designed to facilitate gingival tissue healing and consists of an abutment and retaining screw that are assembled together.

TSV BellaTek Encode Healing Abutments have the Encode Coding scheme on the occlusal surface for simplified digital or traditional impressions to enable creation of an aesthetic, patient-specific Bellatek Abutment in titanium or zirconia designed by your local Encode Empowered laboratory. Please contact a Zimmer Biomet representative for additional information.

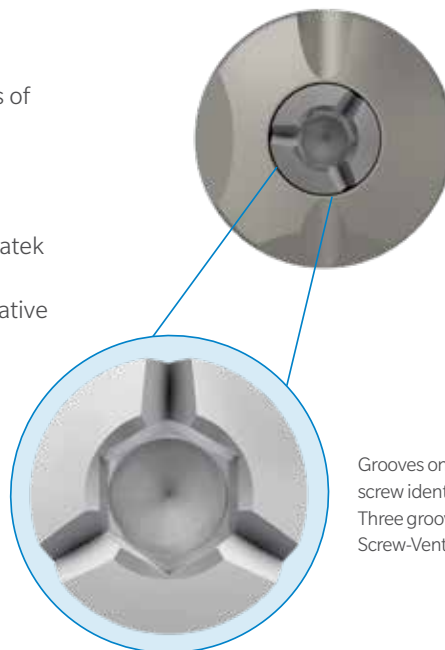

Grooves on the occlusal surface of the screw identify the implant system. Three grooves indicate the Tapered Screw-Vent® Implant System.

Healing Collar Selection Guidelines

Selecting A Healing Collar:

- Determine the size of the implant platform
- Select the emergence profile that best suits the site being restored. The profile should match the transfer and abutment to be used
- Select the cuff height so that the top of the component protrudes slightly above the surrounding tissue. The options are 3.0 mm, 5.0 mm or 7.0 mm

HC3/TEHA3 = 3.5 mmD (Implant Platform) Healing Collar

HC4/TEHA4 = 4.5 mmD (Implant Platform) Healing Collar

HC5/TEHA5 = 5.7 mmD (Implant Platform) Healing Collar

Example:

HC343 = 3.5 mmD (Implant Platform) Healing Collar, 4.5 mmD Emergence Profile, 3.0 mm Cuff Height (second digit equals profile, third digit equals height)

TEHA3383 = 3.5 mmD (Implant Platform) Healing Collar, 3.8 mmD Emergence Profile, 3.0 mm Cuff Height (middle two digits equals profile, last digit equals height)

TSV BellaTek Encode Healing Abutments

Healing collar and impression coping enabling definitive abutment design by your Encode Empowered Laboratory.*



| Implant Platform | Emergence Profile | Cuff Height | | |
|------------------|-------------------|-------------|----------|----------|
| | | 3.0 mm | 5.0 mm | 7.0 mm |
| ● 3.5 mmD | 3.8 mmD | TEHA3383 | TEHA3385 | TEHA3387 |
| ● 3.5 mmD | 5.0 mmD | TEHA3503 | TEHA3505 | • |
| ● 4.5 mmD | 5.0 mmD | TEHA4503 | TEHA4505 | • |
| ● 4.5 mmD | 5.6 mmD | TEHA4563 | TEHA4565 | TEHA4567 |
| ● 4.5 mmD | 6.0 mmD | TEHA4603 | TEHA4605 | • |
| ● 5.7 mmD | 6.8 mmD | TEHA5683 | TEHA5685 | PT564S |

*Not available in all markets.

Healing Collars



| Implant Platform | Emergence Profile | Cuff Height | | |
|------------------|--------------------|-------------|--------|--------|
| | | 3.0 mm | 5.0 mm | 7.0 mm |
| ● 3.5 mmD | 3.5 mmD (No Flare) | HC333 | HC335 | • |
| ● 3.5 mmD | 4.5 mmD | HC343 | HC345 | HC347 |
| ● 3.5 mmD | 5.5 mmD | HC353 | HC355 | • |
| ● 4.5 mmD | 4.5 mmD (No Flare) | HC443 | HC445 | • |
| ● 4.5 mmD | 5.5 mmD | HC453 | HC455 | HC457 |
| ● 4.5 mmD | 6.5 mmD | HC463 | HC465 | • |
| ● 5.7 mmD | 6.5 mmD | HC563 | HC565 | • |

References

1. Williams DF. Titanium as a metal for implantation, part 2: biological properties and clinical applications. *J Med Eng Technol.* 1977 Sep;1(5):266-70.
2. American Society for Testing and Materials Committee on Standards. Designation B 348-94. Standard specification for titanium and titanium alloy bars and billets. *Annual Book of ASTM Standards.* Vol. 02.04. Philadelphia: American Society for Testing and Materials, 1994: 141-146.
3. American Society for Testing and Materials International. Designation F 67-06. Standard specification for unalloyed titanium, for surgical implant applications. 2006.
4. International Organization for Standardization. ISO 5832-2: Implants for surgery – metallic materials - part 2: unalloyed Titanium. 1999. Available online at: <http://www.iso.org>.
5. International Organization for Standardization. ISO 5832-3: Implants for surgery – metallic materials – part 3: wrought titanium 6-aluminum 40-vanadium alloy. 1996. Available online at: <http://www.iso.org>.
6. Data on file with Zimmer Biomet Dental.
7. Trisi P, Marcato C, Todisco M. Bone-to-implant apposition with machined and MTX microtextured implant surfaces in human sinus grafts. *Int J Periodontics Restorative Dent* 2003; 23(5): 427-437.
8. Todisco M, Trisi P. Histomorphometric evaluation of six dental implant surfaces after early loading in augmented human sinuses. *J Oral Implantol.* 2006;32(4):153-166.
9. Shiigai T. Pilot study in the identification of stability values for determining immediate and early loading of Implants. *J Oral Implantol.* 2007;33:13-22.
10. Lee CYS. Immediate load protocol for anterior maxilla with cortical bone from mandibular ramus. *Implant Dent.* 2006;15:153-159.
11. Siddiqui AA, O'Neal R, Nummikoski P, Pituch D, Ochs M, Huber H, Chung W, Phillips K, Wang IC. Immediate loading of single-tooth restorations: one-year prospective results. *J Oral Implantol.* 2008;34:208-218.
12. Artzi Z, Parsori A, Nemcovsky CE. Wide-diameter implant placement and internal sinus membrane elevation in the immediate postextraction phase: clinical and radiographic observations in 12 consecutive molar sites. *Int J Oral Maxillofac Implants.* 2003;18:242-249.
13. Khayat PG, Milliez SN. Prospective clinical evaluation of 835 multithreaded Tapered Screw-Vent implants: results after two years of functional loading. *J Oral Implantol.* 2007;34:225-231.
14. Ormianer Z, Garg AK, Palti A. Immediate loading of implant overdentures using modified loading protocol. *Implant Dent.* 2006;15:35-40.
15. Burgess AV, Story BJ, La D, Wagner WR, LeGeros JP. Highly crystalline MP-1 hydroxylapatite coating. Part I: in vitro characterization and comparison to other plasma-sprayed hydroxylapatite coatings. *Clin Oral Implants Res.* 1999;10:245-256.
16. Chang YL, Lew D, Park JB, Keller JC. Biomechanical and morphometric analysis of hydroxyapatite-coated implants with varying crystallinity. *J Oral Maxillofac Surg.* 1999;57:1096-1108.



Contact us at 1-800-342-5454 or visit

zimmerbiometdental.com

Zimmer Biomet Dental
Global Headquarters
4555 Riverside Drive
Palm Beach Gardens, FL 33410
Tel: +1-561-776-6700
Fax: +1-561-776-1272

Unless otherwise indicated, as referenced herein, all trademarks are the property of Zimmer Biomet; and all products are manufactured by one or more of the dental subsidiaries of Zimmer Biomet Holdings, Inc. and marketed and distributed by Zimmer Biomet Dental and its authorized marketing partners. For additional product information, please refer to the individual product labeling or instructions for use. Product clearance and availability may be limited to certain countries/regions. This material is intended for clinicians only and does not comprise medical advice or recommendations. Distribution to any other recipient is prohibited. This material may not be copied or reprinted without the express written consent of Zimmer Biomet Dental. ZBINST0007 REV D 02/20 ©2020 Zimmer Biomet. All rights reserved.

